

LATEST IN TELEVISION · SERVICING · AUDIO

RADIO — ELECTRONICS

K

HUGO GERNSBACK, Editor

CIRCUITS FOR 6BN6
—
A HIGH-FIDELITY
TRIODE AMPLIFIER
—
VIBRATOR TESTER

8 3/6 x w

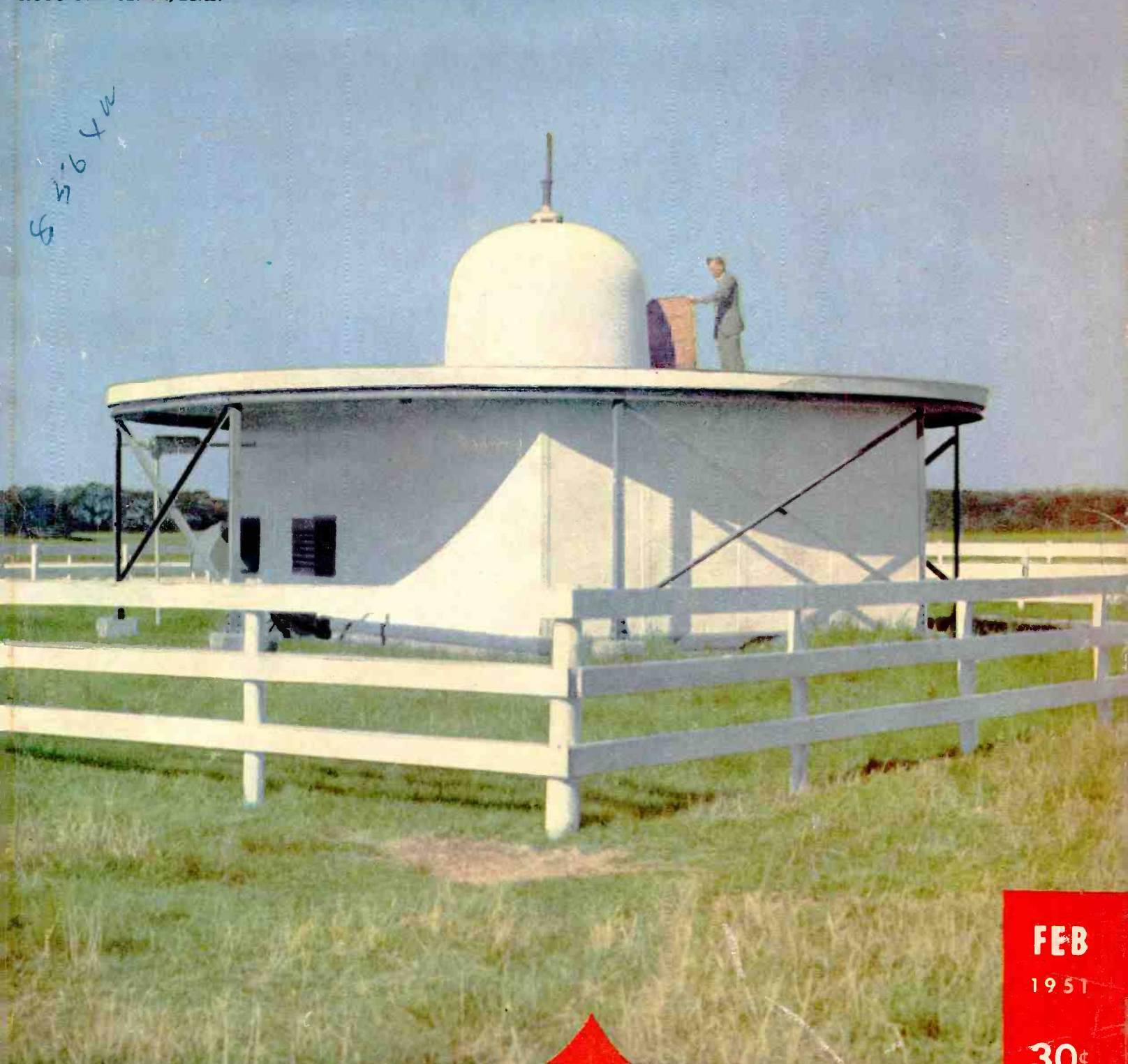

FEB

1951

30¢

U. S. and
CANADIAN

OMNIRANGE — AIR SAFETY — SEE NEW DESIGN SECTION

You get all five

...with RCA Batteries

- 1. Top Brand Acceptance**
- 2. Radio Trade Distribution**
- 3. Completely Rounded Line**
- 4. Radio-Engineered Quality**
- 5. Super Selling Aids**



No other battery line offers you all five of these important selling advantages. That's why RCA is the *one* brand holding *first* place in the profit picture.

Backed by "the greatest name in radio," RCA Batteries enjoy unparalleled consumer acceptance . . . and RCA Batteries give you a clear selling field because they're distributed primarily to the radio trade.

Starting now — push RCA Batteries and watch your business grow!

See your RCA Battery Distributor for fast, reliable service.



The battery for the Radio Trade!



RADIO CORPORATION of AMERICA
RADIO BATTERIES

HARRISON, N. J.



I Will Show You How to LEARN RADIO-TELEVISION SERVICING OR COMMUNICATIONS by Practicing in Spare Time



YOU PRACTICE RADIO SERVICING

You build the modern Radio shown below as part of my Servicing Course. I send you speaker, tubes, chassis, transformer, loop antenna, everything you see pictured and **EVERYTHING** you need to build this modern Radio Receiver. Use it to make many tests, get practical experience.

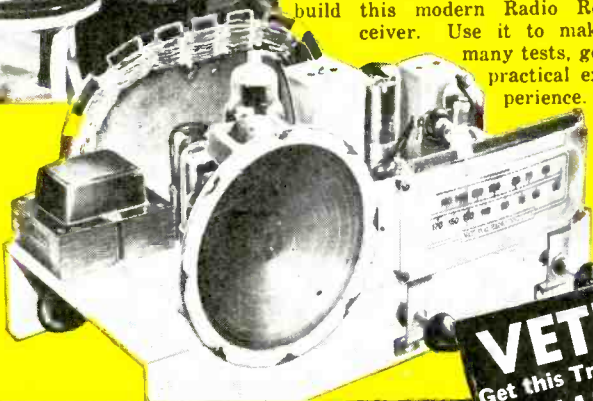

YOU PRACTICE RADIO COMMUNICATIONS

I send you all the parts to build Transmitter shown below as part of my new Communications Course. Conduct actual procedure of Broadcast Operators, practice interesting experiments, learn how to actually put a transmitter on the air.



VETERANS
Get this Training under G. I. Bill
MAIL COUPON

NEW

I TRAINED THESE MEN

"After graduating worked for servicing shop. Now Chief Engineer of three Police Radio Stations."—S. W. D. N. WIDDIE, Jacksonville, Illinois.



"While learning, made \$5 to \$10 a week in spare time. Now have a profitable spare time shop."—L. ARNOLD, Pontiac, Mich.



"I accepted a position as Radio and Television Technician . . . was promoted to manager of Television Service and Installation."—L. HAUGER, San Bruno, California.



"Have my own shop. Am authorized serviceman for five manufacturers and do servicing for 7 dealers."—P. MILLER, Maumee, O.



"When I enrolled, had no idea it would be so easy to learn. Have equipped my shop out of spare time earnings. I am clearing about \$4 to \$60 a month."—J. D. KNIGHT, Denison, Tex.

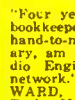

"Four years ago a bookkeeper on a hand-to-mouth salary, am now a Radio Engineer ABC network."—N. H. WARD, Ridgely, Park, New Jersey.

I Will Train You at Home with MANY KITS OF PARTS I SEND

Do you want good pay, a job with a bright future and security? Would you like a profitable shop of your own? The fast growing, prosperous RADIO-TELEVISION industry is making these opportunities for you. Radio alone is bigger than ever. 90 million home and auto Radios, 3100 Broadcasting Stations, expanding use of Aviation and Police Radio, Micro-Wave Relay, Two-Way Radio for buses, taxis, etc., are making opportunities for Servicing and Communications Technicians and FCC-Licensed Operators.

Many Soon Make \$10 A Week Extra in Spare Time Keep your job while training at home. Hundreds I've trained are successful RADIO-TELEVISION TECHNICIANS. Learn Radio-Television principles from illustrated lessons. Get PRACTICAL EXPERIENCE experimenting with circuits common to Radio and Television. Many students make \$5, \$10 a week extra fixing neighbors' Radios in spare time. Special Booklets start teaching you the day you enroll.

Television is TODAY'S Good Job Maker

In 1946 only 6,000 TV sets sold. In 1950 over 5,000,000. By 1954, 25,000,000 TV sets will be in use, according to estimates. Over 100 TV Stations are operating in 35 states. Authorities predict there will be 1,000 TV Stations. This means new jobs, more jobs, good pay for qualified men.

Send Now for 2 Books FREE—Mail Coupon

Send for my FREE DOUBLE OFFER. Get actual Servicing lesson. Also get my 64-page book, "How to Be a Success in Radio-Television." Read what my graduates are doing, earning. Send coupon in envelope or paste on postal. J. E. SMITH, President, Dept. 1B, National Radio Institute, Washington 9, D. C. OUR 38TH YEAR.

NOW! Advanced Television Practice

New, special TV kits furnished to build high-definition SCOPE . . . RF OSCILLATOR with flyback power supply . . . complete TV SET . . . many other units. You see pulse, trapezoidal, saw-tooth wave forms. Get valuable PRACTICAL EXPERIENCE locating and correcting TV troubles. Mail coupon for facts and pictures.

A TESTED WAY TO BETTER PAY...MAIL COUPON NOW

Good for Both—FREE

MR. J. E. SMITH, President, Dept. 1B
National Radio Institute, Washington 9, D. C.
Mail me FREE Lesson and 64-page book.
(No salesman will call. Please write plainly.)

NAME.....AGE.....

ADDRESS.....

CITY.....ZONE.....STATE.....

Check if Veteran Approved for Training Under G. I. Bill

RADIO — ELECTRONICS

Incorporating
SHORT WAVE CRAFT • TELEVISION NEWS •
RADIO & TELEVISION
*Trademark registered U. S. Patent Office

formerly RADIO-CRAFT

MEMBER
AUDIT BUREAU OF CIRCULATIONS

Hugo Gernsback, Editor-in-Chief

M. Harvey Gernsback, Editorial Director

Fred Shunaman, Managing Editor

Robert F. Scott, W2PWG, Technical Editor

Manfred Wentzel, Associate Editor

I. Queen, Editorial Associate

Angie Pascale, Production Manager

Wm. Lyon McLaughlin, Tech. Illustration Director

Lee Robinson, General Manager

John J. Lamson, Sales Manager

G. Aliquo, Circulation Manager

Robert Fallath, Promotion Manager

CONTENTS

FEBRUARY, 1951

Editorial (Page 23)	
War Radio-Electronics.....by Hugo Gernsback	23
New Design (Pages 24-26)	
Omnirange — Air Safety (Cover Article).....by Samuel Freedman	24
Tubes of the Month.....	26
Audio (Pages 27-34)	
Engineered Amplifier Brings Audio Realism	
by A. W. Fite, C. E. Hablutzel, E. D. Nuttall	27
Electronics and Music, Part VIII.....by Richard H. Dorf	30
New Reproducing Curve for Disc Recording.....	32
Audio Feedback Design, Part V.....by George Fletcher Cooper	33
Servicing-Test Instruments (Pages 35-48)	
Rhombic Antenna for TV.....	35
Tester for 6-Volt Vibrators.....by James G. Greer	36
Fundamentals of Radio Servicing, Part XXIV.....by John T. Frye	38
Treat Your Customers Right.....by Richard Laurence	41
Radio and TV Service Review—	
Circuit Features of Philco's 1951 Line.....by Dan Lerner	43
Relays and their Operation, Part I.....by John E. Pitts, Jr.	44
Reducing Cost of TV Servicing.....by Fairbanks Tryon	46
Planned Service Shop Layout Boosts Efficiency and Profit	
by T. W. Dresser	47
Television (Pages 49-58)	
More New Trends in '51 TV.....by Walter H. Buchsbaum	49
Box-Office Television.....By Richard H. Dorf	50
Television Service Clinic.....Conducted by Walter H. Buchsbaum	52
Simple Test Method Evaluates Antennas.....by Ed M. Noll	53
Facts of the Color TV Dispute.....by Jack Gould	54
Speedy Servicing on Outside Calls.....by Albert W. Stock	56
Television DX Reports.....	57
TV by the Sea.....by Alvin B. Kaufman	58
Construction (Pages 60-62)	
Simple Wired Radio Transmitter.....by Rufus P. Turner, K6AI	60
Amateur (Page 63)	
Tuner for Low-Band Antennas.....by James N. Whitaker, W2BFB	63
Electronics (Pages 64-75)	
Novel Impedance Meter.....	64
Timer Input Circuit.....	69
How an Electric Brain Works, Part V	
by Edmund C. Berkeley and Robert A. Jensen	70
Theory and Engineering (Pages 76-79)	
Circuit Adds Vectors.....by L. D. Hindall & J. F. Donan	76
Gated Beam Circuits.....by Edwin Bohr	78
Broadcasting and Communications (Pages 80-81)	
FM Provides Emergency Net.....by James A. Flynn	80
Departments	
The Radio Month.....	12
Radio Business.....	16
Question Box.....	82
Try This One.....	90
New Patents.....	92
Radio-Electronic	
Circuits.....	94
Technotes.....	96
Miscellany.....	98
New Devices.....	104
People.....	106
Communications.....	107
Book Reviews.....	109

ON THE COVER:

The unattended omnirange and direction measuring equipment station at Erie, Pa., first of the new type omnirange transmitters in operation.
Kodachrome by Avery Slack

RADIO-ELECTRONICS, February 1951, Volume XXII, No. 5. Published monthly. Publication Office: Erie Ave., P. O. Box 228, Philadelphia 32, Pa. Entered as second class matter September 27, 1948, at the post office at Philadelphia, Pa., under the Act of March 3, 1879. SUBSCRIPTION RATES: In U. S. and Canada, in U. S. possessions, Mexico, South and Central American countries, \$3.50; \$6.00 for two years; \$8.00 for three years; single copies 30c. All other foreign countries \$4.50 a year, \$8.00 for two years, \$11.00 for three years. Allow one month for change of address. When ordering a change please furnish an address stencil impression from a recent wrapper. RADCRAFT PUBLICATIONS, INC. Hugo Gernsback, Pres.; M. Harvey Gernsback, Vice-Pres.; G. Aliquo, Sec'y. Contents copyright, 1951, by RADCRAFT Publications, Inc. Text and illustrations must not be reproduced without permission of copyright owners. EDITORIAL and ADVERTISING OFFICES, 25 West Broadway, New York 7, N. Y. Tel. REctor 2-9690. BRANCH ADVERTISING OFFICES: Chicago: 320 N. Michigan Ave. Telephone Superior 7-1756. Los Angeles: Ralph W. Harker, 1127 Wilshire Blvd., Tel. MA 6-1271. San Francisco: Ralph W. Harker, 582 Market St., Tel. GARfield 1-2481. FOREIGN AGENTS: Great Britain: Atlas Publishing and Distributing Co., Ltd., London E.C.4. Australia: McGill's Agency, Melbourne. France: Brentano's, Paris 2e. Holland: Trillectron, Heemstede. Greece: International Book & News Agency, Athens. So. Africa: Central News Agency, Ltd., Johannesburg. Capetown: Durban: Natal: Universal Book Agency, Johannesburg. Middle East: Stelmatzky Middle East Agency, Jerusalem. India: Broadway News Centre, Dadar, Bombay 214. K. L. Kamappa Mudaliar, Madras 2, Pakistan: Paradise Book Stall, Karachi 3. POSTMASTER: If undeliverable send form 3578 to: RADIO-ELECTRONICS, 25 West Broadway, New York 7, N. Y.



FREE!

This New TV REPLACEMENT Capacitor MANUAL by SPRAGUE

From A to Z, from Admiral to Zenith, this 16-page book is jam-packed with complete replacement recommendations for critical TV capacitors in 497 television sets from The Technical Service Division of Sprague, world's largest capacitor maker.

Get your copy FREE from your SPRAGUE DISTRIBUTOR or send 10c directly to Sprague to cover handling and mailing costs.

Remember! Avoid costly call-backs in your service work by sticking to Sprague — the capacitors you can depend upon.

SPRAGUE PRODUCTS COMPANY

DISTRIBUTORS' DIVISION OF THE SPRAGUE ELECTRIC COMPANY

81 MARSHALL ST., NORTH ADAMS, MASS.



Learn RADIO

TELEVISION, ELECTRONICS

by

SHOP METHOD HOME TRAINING

Let NATIONAL SCHOOLS, of Los Angeles, a practical Technical Resident Trade School for almost 50 years, train you for today's unlimited opportunities.

You receive all parts, including tubes, for building this fine, modern Superheterodyne Receiver. This and other valuable standard equipment becomes your property.

these two FREE books will tell you how



WE BRING NATIONAL SCHOOLS TO YOU!

GOOD JOBS AWAIT THE TRAINED RADIO TECHNICIAN

You are needed in the great modern Radio, Television and Electronics industry! Trained technicians are in constant and growing demand at excellent pay—in Broadcasting, Communications, Television, Radar, Research Laboratories, Home Radio Service, etc. National Schools Master Shop Method Home Study Course, with newly added lessons and equipment, can train you in your spare time, *right in your own home*, for these exciting opportunities. Our method has been proved by the remarkable success of National Schools-trained men all over the world.

You Learn by Building Equipment with Standard Radio Parts We Send You

Your National Schools Course includes not only basic theory, but *practical* training as well—you *learn by doing*. We send you complete standard equipment of professional quality for building various experimental and test units. You advance step by step until you are able to build the modern superheterodyne receiver shown above, which is yours to keep and enjoy. You perform more than 100 experiments—build many types of circuits, signal generator, low power radio transmitter, audio oscillator, and other units. The Free Books shown above tell you more about it—send for them today!

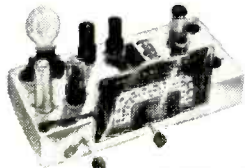

NOW! NEW PROFESSIONAL MULTITESTER INCLUDED

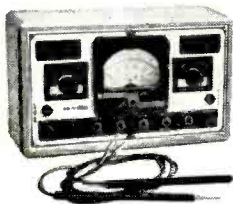

This versatile testing instrument is portable and complete with test leads. Simple to operate, accurate and dependable. You will be able to quickly locate trouble and adjust the most delicate circuits. You can use the Multitester at home or on service calls. It is designed to measure AC and DC volts, current resistance and decibels. You will be proud to own and use this valuable professional instrument.

Lessons and Instruction Material Are Up-to-date, Practical, Interesting

National Schools Master Shop Method Home Training gives you basic and advanced instruction in all phases of Radio, Television and Electronics. Each lesson is made easy to understand by numerous illustrations and diagrams. All instruction material has been developed and tested in our own shops and laboratories, under the supervision of our own engineers and instructors. A free sample lesson is yours upon request—use the coupon below.

TELEVISION TRAINING A complete series of up-to-the-minute Television lessons is an integral part of your course, covering all phases of Television repairing, servicing and construction.

Here are just a few of the interesting facts you learn with the

FREE SAMPLE LESSON

1. How radio receivers operate.
2. How the antenna circuit is constructed.
3. Converting signal currents into sound.
4. How the R-F transformer handles the signal.
5. How the tuning circuit functions.
6. The Radio "bands."

APPROVED FOR VETERANS
Check coupon below.

NATIONAL SCHOOLS

LOS ANGELES 37, CALIFORNIA EST. 1905



MAIL OPPORTUNITY COUPON FOR QUICK ACTION

National Schools, Dept. 2-RE
4000 South Figueroa Street
Los Angeles 37, California

(Mail in envelope or paste on penny postcard.)

Mail me FREE the book "Your Future in Radio-Television" and the sample lesson of your course. I understand no salesman will call on me.

NAME _____ AGE _____

ADDRESS _____

CITY _____ ZONE _____ STATE _____

Check here if veteran of World War II

GET THE DETAILS - SEND THE COUPON →

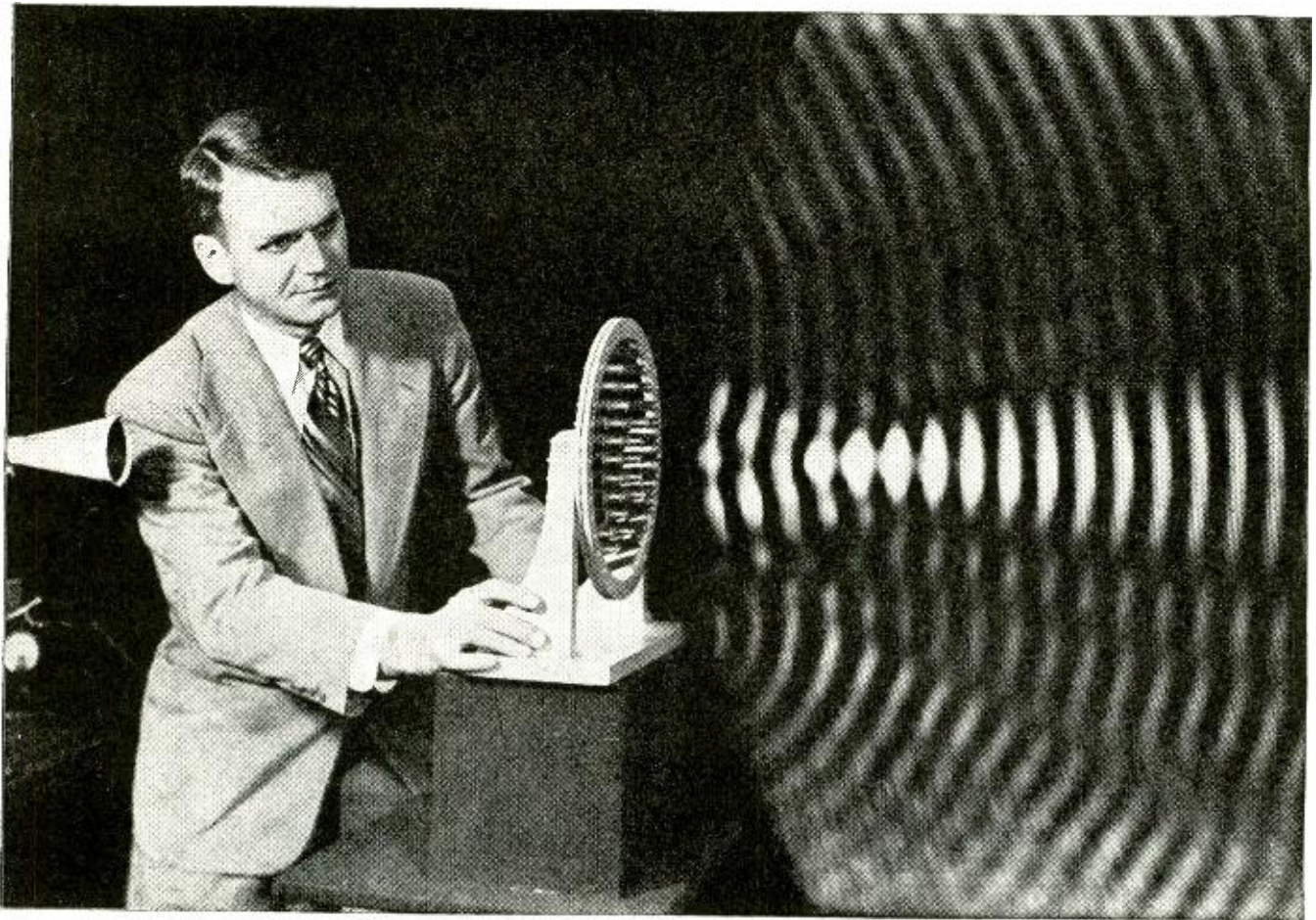

WAVE MAKING

*—for better
telephone
service*

Waves from the sound source at left are focused by the lens at center. In front of the lens, a moving arm (not shown) scans the wave field with a tiny microphone and neon lamp. The microphone picks up sound energy and sends it through amplifiers to the lamp. The lamp glows brightly where sound level is high, dims where it is low. This new technique pictures accurately the focusing effect of the lens. Similar lenses efficiently focus microwaves in radio relay transmission.

At Bell Telephone Laboratories, radio scientists devised their latest microwave lens by copying the molecular action of optical lenses in focusing light. The result was a radically new type of lens — the array of metal strips shown in the illustration. Giant metal strip lenses are used in the new microwave link for telephone and television between New York and Chicago.

The scientists went on to discover that the very same

type of lens could also focus sound . . . thus help, too, in the study of sound radiation . . . another field of great importance to your telephone system.

The study of the basic laws of waves and vibrations is just another example of research which turns into practical telephone equipment at Bell Telephone Laboratories . . . helping to bring you high value for your telephone dollar.

BELL TELEPHONE LABORATORIES



• WORKING CONTINUALLY TO KEEP YOUR TELEPHONE
SERVICE ONE OF TODAY'S GREATEST VALUES

RADIO-ELECTRONICS for

Your Own Secret Weapon is Electronic Training!

Radar-guided glider bomb perfected by Navy. The Bat, first fully automatic guided missile to be successfully used in combat, is now a full-fledged service weapon of the Fleet. The Navy has launched a program to train personnel in technical and operational use. Bats follow their targets through own radar installation, which is in the nose; bomb is carried in fuselage. *Official U.S. Navy Photograph.*

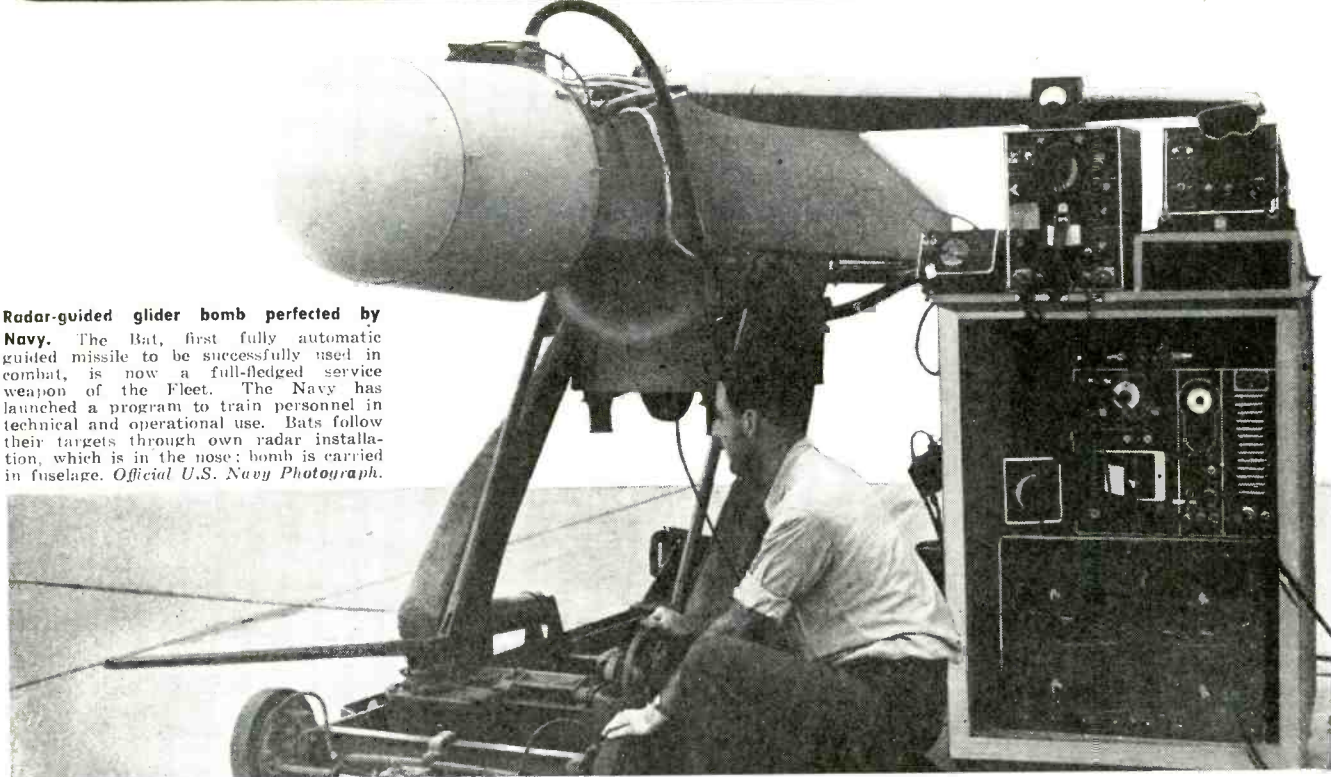

Whether in the Armed Services or in Industry, CREI Training Pays off with More Money . . . Interesting Jobs . . . Secure Careers

Electronics in war directs gunfire, drops bombs, finds enemy planes, "homes" friendly planes, detonates explosives, and finds targets. Any man with electronics training gets an important berth in the Services. Just as essential to industry, the man with advanced electronics know-how is assured of an interesting, well-paid career.

CREI, through home study, offers practical technical training, starting with basic principles. It grounds you thoroughly in the fundamentals required for work in guided missiles, television, and all the important fields of communications and electronics. Thus, with CREI training you qualify for work in an industry that desperately needs qualified men. Or if you enter the armed services, your electronics knowledge quickly puts you in line for promotion.

In World War II CREI trained thousands of men for the Services. In recent peacetime years CREI has been selected by major airlines, manufacturers, networks and top merchandisers to train their own electronics specialists. United Air Lines, Pan American Airways, Canadian Broadcasting Corp., Bendix, RCA Victor, and Sears-Roebuck are just a few of the firms that have paid us to train their men.

Make your own opportunity in electronics. Start preparing at once while there is still time! The next few months can be all-important in determining your future electronics career. Write immediately for complete information. The cost is within reach of all, the terms easy.

THE THREE BASIC CREI COURSES:

- ★ **PRACTICAL RADIO ENGINEERING**
Fundamental course in all phases of radio-electronics
- ★ **PRACTICAL TELEVISION ENGINEERING**
Specialized training for professional radiomen
- ★ **TELEVISION AND FM SERVICING**
Streamlined course for men in "top-third" of field

ALSO AVAILABLE AS RESIDENCE SCHOOL COURSES

CAPITOL RADIO ENGINEERING INSTITUTE

An Accredited Technical Institute Founded in 1927
Dept. 142C, 16th & Park Rd., N. W. Washington 10, D. C.
Branch Office: San Francisco, 760 Market St.



MAIL COUPON FOR FREE BOOKLET

CAPITOL RADIO ENGINEERING INSTITUTE
Dept. 142C, 16th & Park Road, N. W., Washington 10, D. C.

Gentlemen: Send booklet, "Your Future in the New World of Electronics," together with details of your home study training. CREI self-improvement program and outline of course. I am attaching a brief resume of my experience, education and present position.

- Check Field of Greatest Interest:
- | | |
|---|---|
| <input type="checkbox"/> TV, FM & Advanced AM servicing | <input type="checkbox"/> Aeronautical Radio Engineering |
| <input type="checkbox"/> Practical Television Engineering | <input type="checkbox"/> Broadcast Radio Engineering (AM, FM, TV) |
| <input type="checkbox"/> Practical Radio Engineering | <input type="checkbox"/> Radio-Electronics in Industry |
- If Residence School Preferred, Check Here

NAME _____ AGE _____
ADDRESS _____
CITY _____ ZONE _____ STATE _____

PERFECT

Fringe Area

RECEPTION

IS AS SIMPLE AS



You can have nearly perfect TV reception — strong, "snow"-free images — regardless of how faint an image you now receive — with the complete Tel-a-Ray System for fringe areas! It's simple and economical.

The first step in the Tel-a-Ray System is the Tel-a-Ray "T" antenna, which consistently receives images from stations 200 miles away.

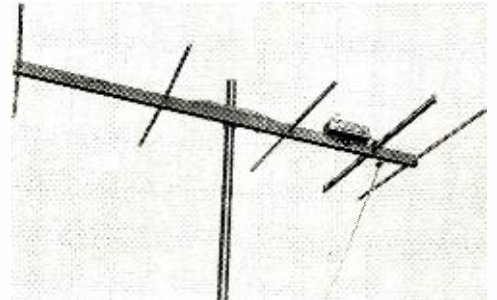

To your Model T antenna, mount the new, powerful Tel-a-Ray Pre-Amplifier. This amazing new product of the Tel-a-Ray Research Department eliminates, or greatly reduces, "snow."

Because it mounts right to the antenna, it has a high signal-to-noise ratio, bringing you stronger, clearer pictures with less noise. It furnishes consistent reception beyond the fringes and eliminates matching problems and line loss. It is completely weather-resistant, like all Tel-a-Ray products, and sells at a much lower price than other antenna-mounted amplifiers or boosters.

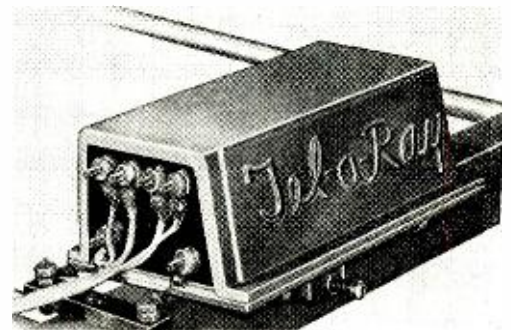

WITH THE COMPLETE *Tel-a-Ray System*

The final step that brings you almost perfect TV reception is your TV receiver. This simple parlay, A-B-C, is your guarantee of hours of television pleasure, unmarred by foggy images and irritating noise.



FOR PRIMARY AREAS

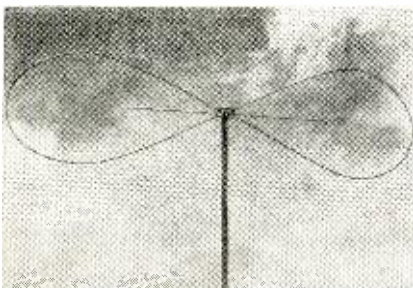

The Tel-a-Ray Butterfly receives 13 channels and FM radio. Guaranteed to be weather-resistant, it will consistently provide the best reception possible. And the price is just \$2.95 (suggested list).

Televiewers throughout the country have come to associate the name Tel-a-Ray with good reception through quality products. If you have a particular reception problem, Tel-a-Ray engineers will be glad to help you.

Tel-a-Ray
ENTERPRISES, INC.
 P.O. Box 332A HENDERSON, KY.

NOW... GET EVERYTHING YOU NEED TO LEARN AND MASTER

TELEVISION

RADIO-ELECTRONICS ...AT HOME!

Use REAL commercial-type equipment to get practical experience

Your future deserves and needs every advantage you can give it! That's why you owe it to yourself to find out about one of the most COMPLETE, practical and effective ways now available to prepare AT HOME for America's billion dollar opportunity field of TELEVISION-RADIO-ELECTRONICS. See how you may get and keep the same type of basic training equipment used in one of the nation's finest training laboratories... how you may get real STARTING HELP toward a good job or your own business in Television-Radio-Electronics. Mail the coupon today for complete facts — including 89 ways to earn money in this thrilling, newer field.



Here's the REAL THING!

SET UP YOUR OWN HOME LABORATORY



Oscilloscope

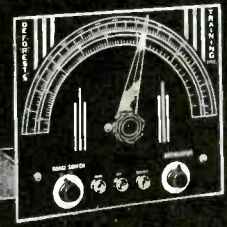

R-F Signal Generator

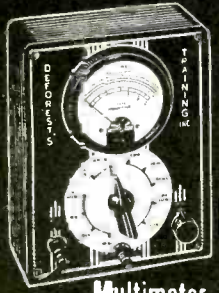

Multimeter

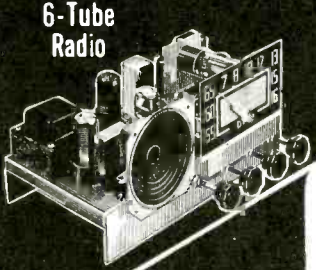

6-Tube Radio



HOME MOVIES

ABOVE: Build and keep a real 16 INCH commercial TV receiver. Optional after completing regular training at slight additional cost.

D.T.I., ALONE, INCLUDES BOTH MOVIES and HOME LABORATORY. In addition to easy-to-read lessons, you get the use of HOME MOVIES — an outstanding training advantage — plus 16 big shipments of Electronic parts. Perform over 300 fascinating experiments for practical experience. Build and keep real commercial-type test equipment shown at left.

Get BOTH of these information packed publications FREE!

MODERN LABORATORIES

If you prefer, get all your preparation in our new Chicago Training Laboratories—one of the finest of its kind. Ample instructors, modern equipment. Write for details!

MILITARY SERVICE!

If you're subject to military service, the information we have for you should prove doubly interesting. Mail coupon today.



ACT NOW! MAIL COUPON TODAY!

DeFOREST'S TRAINING, INC., Dept. RE-2H
2533 N. Ashland Ave., Chicago 14, Ill.

Without obligation, I would like your late News-Bulletin showing 89 ways to earn money in Television-Radio-Electronics... and how I may prepare to get started in this thrilling field.

Name..... Age.....
Street..... Apt.....
City..... Zone..... State.....

De FOREST'S TRAINING, INC.
CHICAGO 14, ILLINOIS
A De VRY INSTITUTION

Announcing **CENTRALAB'S**

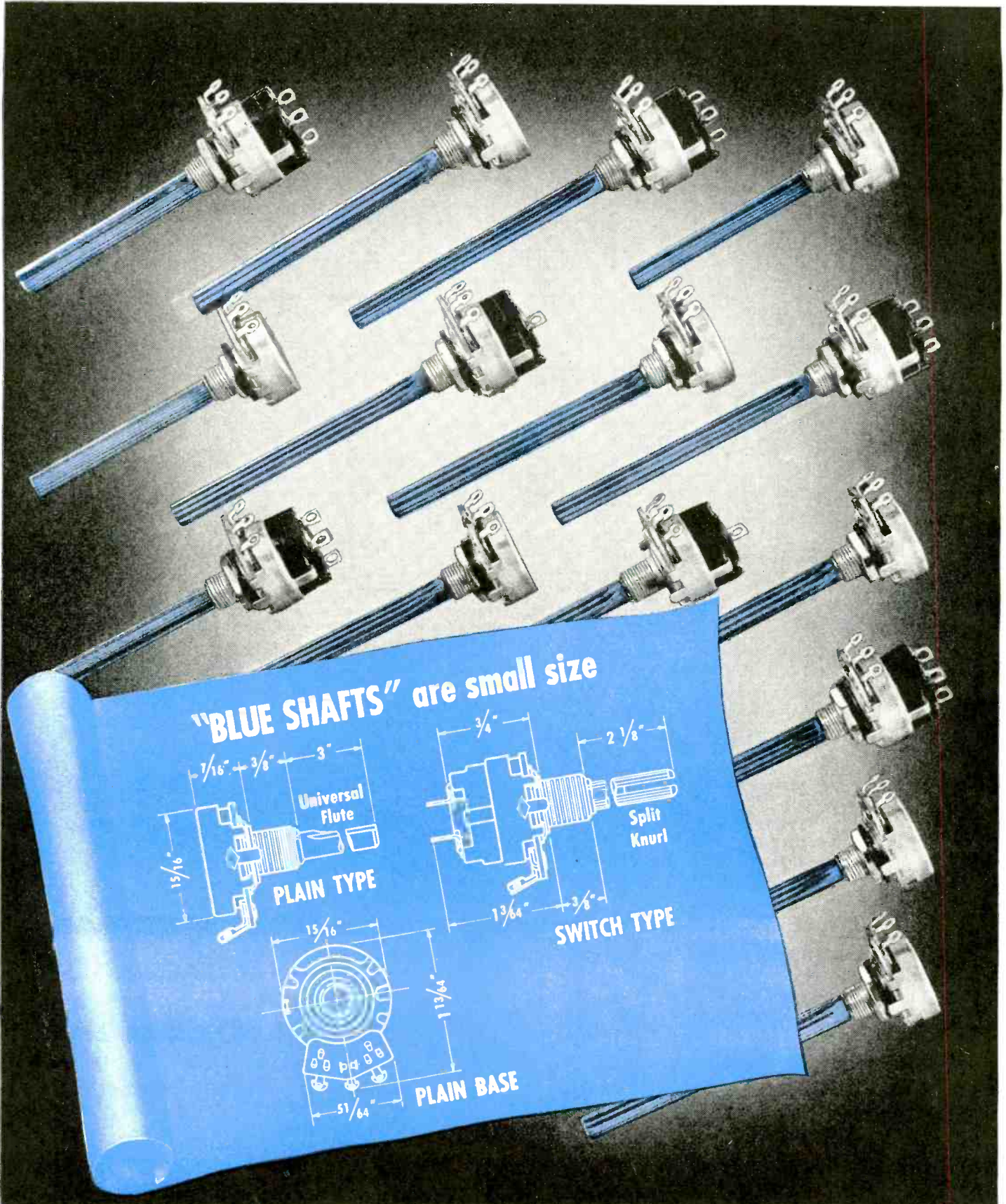

NEW Blue Shaft **CONTROLS**

Centralab now offers service engineers...today's finest replacement controls . . . quickest for servicing . . . at today's most favorable prices

8 Reasons why "Blue Shafts" are better

1. Blue Shaft controls are complete, ready-to-use units — factory assembled and tested including switches. No time lost fussing with assembly — smooth action guaranteed.
2. Blue Shaft Controls are *small size* — only 15/16" diameter — meet any modern service requirement.
3. Shafts — Standard Model B — 3" long — universal fluted — full length mill. Model BSK — 2 1/8" long with split knurl.
4. Switches — positive throw in both "on" and "off" positions. Terminals — surfaces elevated to eliminate danger of shorting to cover legs . . . 1/8" hole diameter for quick wiring . . . hot tin dipped for easy soldering.
5. Contact Spring gives you double wiping contacts on both resistor and center terminal ring . . . to insure noiseless operation.
6. Blue Shaft resistors are made of special resistance material bonded to high quality phenolic for smooth operation, low noise level, outstanding humidity characteristics.
7. Insulator's high dielectric strength permits breakdown test at 1000 volts R. M. S. *Dust and dirt can't get in.*
8. Blue Shaft Controls are produced and *guaranteed* by Centralab — the company that *introduced* carbon-type controls to the radio industry 25 years ago!

"Blue Shafts" offer complete range of all Values

Service engineers! Centralab's new Blue Shaft controls are an exclusive *service item* and are available in a complete line of plain and switch types. Resistance ranges from 500 ohms to 10 megohms in a wide variety of tapers and tapped units suitable for any circuit.

Blue Shaft Controls are available packaged singly, in handy plastic boxes containing 12 — and in a special metal cabinet containing 22 controls—*No extra charge for the cabinet.* Ask your nearest Centralab distributor for complete details on all Blue Shaft controls.

Check These LOW PRICES on Popular Size Controls!

Cat. No.	Ohms Max. Resistance	Taper Location	Circuit	List Price
B-60	500,000	C-2 (audio)	Volume or Tone	\$1.00
B-60-S*	500,000	C-2 (audio)	Volume or Tone	\$1.50
B-70	1 megohm	C-2 (audio)	Volume or Tone	\$1.00
B-70-S*	1 megohm	C-2 (audio)	Volume or Tone	\$1.50

*Switch Type

Get More Information . . . You can get complete information on the entire Blue Shaft line of replacement controls from Centralab's new Bulletin No. 42-106. Ask your jobber or write direct.



CENTRALAB DIVISION OF GLOBE-UNION INC., 922 East Keefe Avenue, Milwaukee 1, Wisconsin

Please send me Blue Shaft Control Bulletin No. 42-106 Include new Centralab Catalog No. 27

Name.....

Company Name.....

Address.....

City.....Zone.....State.....

Please!

Your Distributor's Name.....

Address.....

City.....Zone.....State.....

Watch
MERIT
for TV in '51

Merit is meeting the rapidly rising demand for TV replacements with a TV line as complete as current and advance information will permit

TRY MERIT FIRST FOR TV CONVERSION OR REPLACEMENT!



HV06—Universal Ferrite core "FLYBACK" permits widest coverage.



MDF70—70" high efficiency Ferrite yoke for tubes up to 19"



MWC-I—Width linearity control with AGC winding (Automatic Gain Control).

FOCUS COILS



Free!

Write today for:

- MERIT TV REPL GUIDE AND CATALOG**
—Dec. 1950 issue. Up-to-date listing of all replacements.
- MERIT 1951 CATALOG No. 5111**
Show specs. on complete line of TV, Radio, Amateur and Industrial Transformers.

REFER TO MERIT'S LISTING
IN HOWARD SAM'S PHOTOFACTS



TAPE-MARKED TO HELP YOU!

Hand-tape marking on every Merit Transformer shows permanent hook-up data for quick reference. **ORIGINATED BY MERIT.**



MERIT
TRANSFORMER CORP.

4443 NORTH CLARK ST., CHICAGO 40, ILL.

SNOW LANDINGS by instrument will be possible with new equipment developed by the Civil Aeronautics Administration. Present landing equipment uses a radio beam which is reflected from the ground to guide planes into the runway. When the snow is deep, the error in the glide path may be as much as 1° in the 2° or 3° slope. The new system uses two antennas on the same pole to transmit the glide path, and these provide a null reference for each other. Older systems are easily modified to this new method and all CAA-controlled airports will soon have this equipment.

PROJECT TYPHOON is the name of a new electronic analog computer built to evaluate the performance of guided missiles, ships, aircraft, and submarines and to aid in the air protection of American cities. Completed recently at RCA's Princeton, N. J., laboratories, Typhoon reduces the need for costly working models of various types of projectiles by evaluating the performance of any design from small scale models.

In its first public demonstration, Typhoon was shown solving a simulated air defense problem in which a high speed bomber was successfully attacked by a radar-controlled guided missile. Information needed to solve the problem was set up in the computer, with different dial positions and plug-in connections representing the aerodynamics of the missile, loss of weight due to fuel consumption, and other characteristics of the problem. When the computer started to operate, the paths of both bomber and missile were traced by red and green pens on two large plotting boards. At the same time 12 recording voltmeters indicated the positions of the fins, acceleration, velocity, and rate of spin of the missile as well as the remaining distance between mis-

sile and target. Spectators could follow the problem by means of two fluorescent balls which traveled the same course as the missile and its target.

GERMANIUM DEPOSITS, in sufficient concentrations that it may be possible to exploit the clay and sand in which they occur, have been found in New Jersey's northeastern Middlesex County. Two samples recently analyzed by State Geologist M. E. Johnson were found to contain 0.21 and 0.14% germanium. While this is a lean ore, the current price of over \$230 a pound may make its mining feasible, especially if defense needs increase the demand for this rare metal.

Although germanium was discovered in 1886, it was too costly and rare for practical use until it was found that thin sheets of the metal could be used to rectify electrical currents. The electronics industry was quick to make use of this property because of the great space-saving of the germanium diodes. It was at the request of a manufacturer of electronic equipment that Johnson made his investigations in New Jersey.

UNDERWATER SOUND can be picked up by an entirely new method recently reported to the Acoustical Society of America. When ultrasonic waves strike a wire covered with a porous coating and immersed in water, an alternating potential of the same frequency as the waves is set up within the wire. The kind of metal used in the wire makes no difference, but the effect seems to depend on the kind of porous coating and on the solution with which the wire is covered. The voltage produced is very small, but it can be amplified to useful magnitudes. This discovery may be useful for submarine detection and it will be used for laboratory study of various kinds of underwater effects.

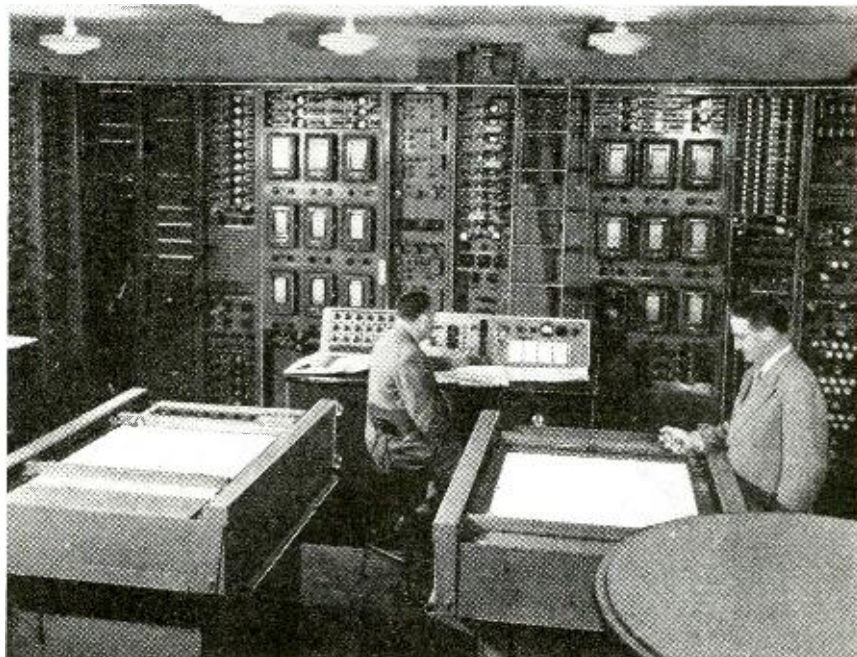

A. W. Vance, left, is at the control panel, while R. S. Holmes checks the missile and target trajectory on one of the two plotting boards of Project Typhoon.

RADIO-ELECTRONICS for



**I Send You
18 BIG
KITS
OF RADIO-
TELEVISION
EQUIPMENT**

Train at Home in Spare Time for **RADIO** and **TELEVISION**

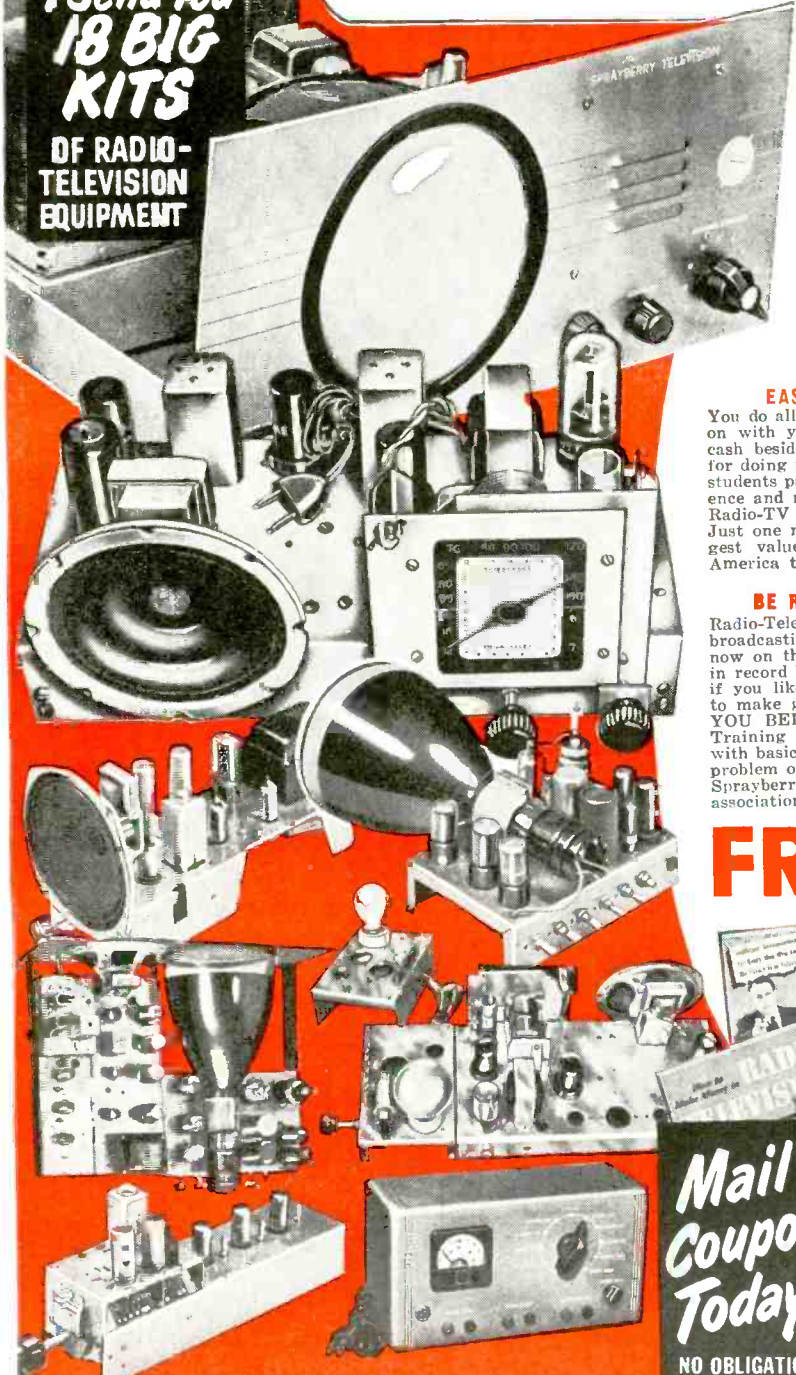

My Famous Training System Prepares You Double Quick For a Good Job or Your Own Profitable Radio-Television Business

Radio-Television is now America's greatest opportunity field! Trained men are needed to fill good jobs and handle profitable Radio-Television Service work. I have trained hundreds of men for success in Radio-Television—and I stand ready to Train you too, *even if you have no previous experience.* My training is 100% practical—designed to give you the knowledge and experience you need to make money in Radio-Television in the shortest possible time. I Train you with up-to-the-second revised lessons—PLUS many big kits of Radio-Television equipment. You actually do over 300 demonstrations, experiments and construction projects. In addition, you build a Powerful 6-tube-2-band radio, a multi-range test meter and a complete Television receiver! All equipment is **YOURS TO KEEP.**

EASY TO MAKE EXTRA MONEY WHILE YOU LEARN

You do all your training with me **AT HOME** in spare hours. Keep right on with your present job and income while learning—and earn extra cash besides! The day you enroll I begin sending you plans and ideas for doing profitable spare time Radio-TV work. Many of my Sprayberry students pay for their entire training this way! You get priceless experience and many plans for making extra money. You build all your own Radio-TV Test Equipment from parts I send you—nothing else to buy. Just one more reason why I believe I offer the ambitious man the biggest value in top notch Radio-TV Training available anywhere in America today.

BE READY FOR TOP PAYING RADIO-TELEVISION JOBS

Radio-Television is growing with amazing speed. More than 2000 Radio broadcasting stations PLUS an additional 102 Television stations are now on the air. Radio sets and TV receivers are being made and sold in record breaking numbers. If you enjoy working with your hands . . . if you like to do interesting and varied work . . . if you really want to make good money and work in an industry that has a future . . . **YOU BELONG IN RADIO-TELEVISION.** But you **MUST** have good Training to "cash in" . . . the kind of training that starts you out with basic fundamentals and carries you right through every circuit and problem of Radio-Television Servicing and Repair. In a word . . . that's Sprayberry Training . . . the course backed by more than 20 years of association with the Radio-Television industry!

FREE 3 BIG RADIO AND TELEVISION BOOKS

I want you to have ALL the facts about my complete system of Radio-Television Training! Act now! Rush the coupon for my three big Radio-Television books: "How To Make Money in Radio-Television," PLUS my new illustrated Television bulletin PLUS an actual sample Sprayberry Lesson—all FREE with my compliments. No obligation and no salesman will call on you. Send the coupon in an envelope or paste on back of post card. I will rush all three books at once!

**Sprayberry Academy of
Radio, Dept. 20-T**

111 North Canal St., Chicago 6, Ill.

**Mail
Coupon
Today!**

**NO OBLIGATION
No Salesman
Will Call**

SPRAYBERRY ACADEMY OF RADIO, Dept. 20-T
111 North Canal St., Chicago 6, Ill.

Please rush to me all information on your Radio-Television Training plan. I understand this does not obligate me and that no salesman will call upon me.

Name..... Age.....

Address.....

City..... State.....

Please Check Below About Your Experience

Are You Experienced?

No Experience

VETERANS: My Radio Training is Approved by Veterans.

IF YOU ARE EXPERIENCED In Radio I'll qualify you for Television in 4 to 8 weeks. Rush coupon.



Music—sweet music to his ears!

And why not? A satisfied customer has telephoned—yes, actually telephoned—to thank this service-dealer for the swell repair job on his TV sets.

Your customers may not take the trouble very often to do this, but you can bet your last dime that a *dissatisfied* customer will lose no time in telling you what he thinks. This means call-backs on which you lose time, money, and reputation.

The trick, of course, is to eliminate call-backs. Unfortunately, you can't eliminate them *all*. But, you can keep them to a minimum by using only parts on which you can stake your reputation.

Look at any tube marked TUNG-SOL. There is the same tube—the same performance standards—the same dependability which eight out of ten leading set manufacturers use for initial equipment. All TUNG-SOL tubes are made to meet their requirements. So, when you make replacements with TUNG-SOL tubes, you're putting back into the set the same high quality with which it left the factory.

This TUNG-SOL "one standard" policy safeguards your service work, your prestige and your profit.

Tell your distributor's salesman you'd rather have TUNG-SOL tubes.

TUNG-SOL LAMPWORKS INC., NEWARK 4, N. J.
Sales Offices: Atlanta, Chicago, Dallas, Denver,
Detroit, Los Angeles, Newark



ONE STANDARD—The best that can be made
For Initial Equipment and Replacement

FM POPULARITY has increased at a greater rate during the past year than in previous years according to a survey made by six stations which cover central Massachusetts and part of Connecticut. FM set ownership in the area covered by the survey increased by 29% during 1950—a 9% greater increase than during the previous year. Successive surveys since 1947 show an increasing swing from AM to FM each year. One conclusion from these surveys is that the further away from AM stations the listeners live, the more eager they are to alleviate the static and fading of AM broadcasting.

EDUCATIONAL TV is being urged upon the FCC by seven major groups of educators who presented their case in a two-week hearing before the Commission. Banded together as the Joint Committee for Educational Television, the group requested that at least 20% of the proposed u.h.f. band, and at least one v.h.f. channel in each broadcast area be reserved for noncommercial educational use.

Among those testifying was Miss Grace Rawlings, a Baltimore elementary school principal, who represented 15,000 principals of the National Education Association. Terming television "as important a force in modern life as the library," she said that Baltimore schools want at least five hours of TV time a day, which she felt sure the commercial stations would not contribute voluntarily. Other witnesses stated similar cases and urged reservations of channels for education.

Miss Frieda Henneck, FCC Commissioner, has urged that 25% of any new station allocations be reserved for educational use. At a press conference, Miss Henneck said that the big problem is "educating the educators" who do not seem to have grasped the full opportunities the medium has to offer. She also indicated that if more broadcast channels could not be found, the possibility exists of taking licenses away from present stations which are not using them in what the Commission terms the public interest, and turning them over to educational institutions. Miss Henneck further urged that educational groups take more interest in television, even to the point of banding together to apply for station licenses.

Paul V. Galvin, president of Motorola, one of the "big four" TV manufacturers, declared his support for assigning TV channels for educational use. Pointing out that TV has been used successfully for education in Philadelphia and Baltimore and at Iowa State College, Mr. Galvin said that "television may prove to be the cheapest and most effective way to educate the greatest number of people."

COLOR TUBE IMPROVEMENTS, RCA's major argument against the FCC's decision on color TV of last fall, were demonstrated recently to representatives of the industry and the press. Refinements in the tri-color tube include high definition achieved through

an increase in the number of color dots on the tube face and new red and blue phosphors which add to picture brightness and eliminate optical filters.

Other improvements in the RCA system are simpler circuits in the receivers and increased picture brightness. Improved circuits at the transmitter end also contribute to better pictures in color.

Three receivers using the 16-inch tri-color tube, similar in appearance to black-and-white console receivers, were used at the demonstration; and images in a wide range of colors were reproduced. A 16-inch standard RCA black-and-white receiver converted for color was also shown as well as a slave set.

COLOR TV SUIT, filed by RCA against the FCC for its decision approving CBS color television, was dismissed in a two-to-one decision by the U. S. District Court in Chicago. However, the court continued the temporary restraining order until April 1951, or until it is terminated by the U. S. Supreme Court.

In giving the majority opinion, Circuit Court Judge J. Earl Major said that both parties in the controversy had greatly elaborated the importance of the public interest, and that "the contest is mainly between two great broadcasting systems for a position of advantage in this rapidly developing field of television."

LARGE COLOR PICTURES are now possible with the CBS system using a new device called the color drum. Demonstrated recently by CBS, the device revolves around the picture tube lengthwise, somewhat like a ferris wheel. It has been used with screens as large as 17 inches, and officials of the network said the drum can be used with 20-inch tubes as well.

The color tube and drum are mounted in a separate cabinet and operate as a slave unit of a master control set. The tube is set well back in the cabinet so that there is ample room for the drum to come down over its face. Wide angle viewing is possible through a large, glass-covered front opening.

THIRD CUBAN TV STATION is now under construction in Havana and will be on the air sometime early this year. The new station will be operated by Telenews, a Cuban firm, and its equipment is being supplied by RCA. The two other Cuban stations now on the air are CMQ-TV and Union Radio TV, both in Havana.

TELEVISION BROADCASTERS held their annual meeting in New York recently. The theme of the one-day meeting was a Television Clinic designed to aid Television Broadcasters Association members and other interested parties to solve some of their TV problems. The talks given by TBA members discussed such problems as programming, audience research, TV station sales, and the use of movie films in TV. Comedian Ed Wynn was the guest speaker at the annual TBA luncheon.

Which Do You Want?



Better Pay



A Nice Home

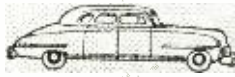

A New Car



Greater Security



Happy Vacations and Travel

Get Your FCC Ticket Then Use Our Amazingly Effective Job-Finding Service To Get a Better Job

Add Technical Training to Your Practical Experience and

Get Your FCC COMMERCIAL RADIO OPERATOR LICENSE



I can train you to pass your FCC License Exams in a few short weeks if you've had any practical radio experience—amateur, Army, Navy, radio servicing or other. My time-proven plan can help put you, too, on the road to success.

Let me send you FREE the entire story just fill out the coupon and mail it. I will send you, free of charge, a copy of "How to Pass FCC License Exams," plus a sample FCC-type Exam, and the amazing new booklet, "Money Making FCC License Information." Edw. H. Guilford Vice President

in a Minimum of Time

Get this Amazing Booklet FREE

TELLS HOW —

WE GUARANTEE

TO TRAIN AND COACH YOU AT HOME IN SPARE TIME UNTIL YOU GET

YOUR FCC LICENSE

TELLS HOW —

Employers Make

JOB OFFERS Like These to Our Graduates Every Month

Telegram, August 9, 1950, from Chief Engineer, Broadcast Station, Pennsylvania "Have job opening for one transmitter operator to start immediately, contact me at once."
 Letter, August 12, 1950, from Dir. Radio Div. State Highway Patrol, "We have two vacancies in our radio communication division. Starting pay \$200; \$250 after six months' satisfactory service. Will you recommend graduates of your school?"
 Letter, August 24, 1950, from radio-television sales and service company, Ohio, "We are in need of a good television man. The pay will be good, also good surroundings to work in. Please let us hear from you."
 Telegram, Sept. 7, 1950, from Chief Engineer, Broadcast Station, Georgia, "Have immediate opening first phone engineer. Prefer one with usable voice, experience not necessary. Prefer man from small town. Beginning pay \$18 for 18 hours."

HERE'S PROOF FCC LICENSES ARE OFTEN SECURED IN A FEW HOURS OF STUDY WITH OUR Coaching AT HOME in Spare Time

Name and Address	License	Lessons
Lee Worthy 22114 1/2 Wilshire St., Bakersfield, Cal.	2nd Phone	16
Clifford E. Vogt Box 1016, Dania, Fla.	1st Phone	20
Francis K. Foerch 38 Bueller Pl., Bergenfield, N. J.	1st Phone	38

CLEVELAND INSTITUTE OF RADIO ELECTRONICS

Desk RE-26, 4900 Euclid Bldg., Cleveland 3, Ohio
 (Approved for Veteran Training Under "GI Bill of Rights")

FEBRUARY, 1951

TELLS HOW —

Our Amazingly Effective JOB-FINDING SERVICE

Helps CARE Students Get Better Jobs

Here is just one recent example of Job-Finding Results

Gets Five Job-Offers From Broadcast Stations

"Your 'Chief Engineer's Bulletin' is a grand way of obtaining employment for your graduates who have obtained their 1st class license. Since my name has been on the list, I have received calls or letters from five stations in the southern states, and am now employed as Transmitter Engineer at WJMT." Elmer Powell, Box 274, Sparta, Tenn.

Your FCC Ticket is always recognized in all radio fields as proof of your technical ability.

Get All 3 FREE

MAIL COUPON NOW

Cleveland Institute of Radio Electronics
 Desk RE-26—4900 Euclid Bldg., Cleveland 3, Ohio
 (Address to Desk No. to avoid delay)

I want to know how I can get my FCC ticket in a minimum of time. Send me your FREE booklet, "How to Pass FCC License Examinations" (does not cover exams for Amateur License), as well as a sample FCC-type exam and the amazing new booklet, "Money Making FCC License Information."

Name

Address

City.....Zone.....State.....

Veterans check for enrollment information under G.I. Bill.





NO SHADOWS

with new
DUAL SPOTLIGHT
Soldering Gun

Pull the trigger of your new light-duty Weller Soldering Gun, and instantly twin spotlights focus on the job—banish every shadow. Five seconds later the tip is at soldering heat! No waiting. No wasted current. This streamlined 135-watt—newest of the famous Weller line—is fast!

Built compactly for working in crowded chassis, too. And the time and power you save pays for your Weller Gun in a few months.

New
135-Watt
Weller
Soldering
Gun

Specially Designed
for TV and Radio Work

- **DUAL SOLDERLITE**—Two prefocused spotlights completely eliminate shadows.
- **OVER/UNDER DESIGN**—Tube construction braces front and improves visibility.
- **5-SECOND HEATING**—Pull the trigger and you solder!
- **LONGER REACH**—Slides easily into deep chassis; reaches the tightest corners.
- **GREATER CAPACITY**—Smaller, lighter, with greater soldering capacity.
- **TRIGGER-SWITCH CONTROL**—Adjusts heat to the job. No need to unplug gun between jobs.
- **DUAL HEAT**—Single heat 100 watts; dual heat 100/135 watts; 120 volts; 60 cycles. Handles all light-duty soldering.

See new Models WS-100 and WD-135 at your distributor, or write for bulletin direct.

• **SOLDERING GUIDE**—Get your new copy of "Soldering Tips"—revised, up-to-date, fully illustrated 20-page booklet of practical soldering suggestions. Price 10¢ at your distributor, or order direct.

WELLER
ELECTRIC CORP.

828 Packer Street, Easton, Pa.

Merchandising & Promotion

Littelfuse, Inc., of Chicago, has added a revolving dispenser to its merchandising aids. The dispenser consists of two metal drums with slide channels, will hold up to 3,600 fuses. When both drums are used as a counter display, they stand 24 inches high. There is a nominal charge for the drums, subject to discounts with the purchase of fuses.

Simpson Electric Co., of Chicago, has issued an illustrated folder on six of its instruments for FM and TV Servicing. A plate-conductance tube tester, a field-strength meter and a vacuum-tube volt-ohmmeter are included in the group. The pamphlet provides a space for the distributor's imprint. The pamphlets are available either from distributors or directly from the Simpson Electric Company.

Weller Electric Corp. has issued a new edition of its popular 20-page pocket manual, *Soldering Tips*. The book is both a handy reference for professionals and a simplified course for beginners. The booklet may be obtained from the Weller Electric Corp., Easton, Pa., by sending 10¢ in coin.

Concord Radio Corp., Chicago, has published a 4-page bulletin to aid high-fidelity enthusiasts in planning a modern music system. The bulletin lists five basic components of a high-fidelity music system. It is illustrated with drawings and pictures. The bulletin may be had without charge from the Concord Radio Corp., 901 West Jackson Blvd., Chicago 7, Illinois.

Production & Sales

The RTMA reported receiving-tube sales for October at 40,105,611, a new record high for the third consecutive month. The breakdown for October sales showed 32,305,648 for new sets; 6,699,448 for replacements; 918,338 for export; and 182,177 for government agencies. Receiving-tube sales for the first 10 months of 1950 totalled 304,910,357. Television picture tube sales to manufacturers for the first 10 months of 1950 reached 5,934,391. During the month of October, 92% of the 848,387 TV picture tubes sold were 16-inch or larger and 58% were rectangular.

The aggregate TV receiver production for the first 11 months of 1950 was estimated at 6,529,615 sets by the RTMA. This figure represents production by both member and nonmember companies. November radio and television production both dropped 8% below the previous month's output. The November TV set production amounted to 752,005 units, and radio receivers totaled 1,304,094, according to RTMA estimates. In the 11-month period, radio receiver output, including home sets, auto, and portables, totaled 12,785,917.

The NBC-TV Sales Planning and Research Department estimated total TV set ownership in the United States as of November 1, 1950, at 9,169,300. A partial breakdown showed New York with 1,825,000; Los Angeles, 735,000; Chicago, 710,000; Philadelphia, 695,000; Boston, 580,000; Detroit, 356,000;

Cleveland, 349,000; Baltimore, 240,000; St. Louis, 207,000; Cincinnati, 196,000.

New Plants and Expansions

General Electric will reopen a former radio tube plant in Utica, N. Y., and convert it to manufacture emergency radio communications equipment. It is expected to be in full operation, employing 425 people, by June, 1951.

Westinghouse Electric Corp. has begun negotiations for a tract of land in Baltimore. It plans to build a factory to meet expanding military demands for products of its Electronics and X-Ray Division.

A Philco Corp. subsidiary, Lansdale Tube Co., has purchased a site at Frederick, Maryland, for a new plant to manufacture electronic tubes for the armed forces and essential civilian requirements. Construction will begin early this year and the plant is expected to be in operation before 1952.

Simpson Electric Co., Chicago, has leased a new plant in Aurora, Ill. This is the company's fifth plant now making Simpson panel instruments and test equipment.

Philharmonic Radio Corp. has purchased a plant in New Brunswick, N. J., to manufacture TV receivers, radios and radio-phonographs. Philharmonic's past operation depended on production by subcontractors.

Lewis & Kaurman, Inc., Los Gatos, Cal., has increased its plant capacity by 25%. The company makes tantalum- and zirconium-molybdenum-anode power tubes.

Phoenix Electronics, Inc., Lawrence, Mass., has expanded production of its line of TV antennas and products. The company recently moved to larger quarters and has since installed its own plating division.

Hoffman Radio Corp. has added two new plants; one in Los Angeles and another in Vernon, Cal. This makes a total of nine plants owned by the company.

Financial Reports

	1950	1949
Allen B. Du Mont Labs. (40 weeks to Oct. 1950)		
Earnings	\$5,018,000	\$1,677,000
Sales	\$52,273,000	\$29,507,000
Zenith Radio Corp. (Quarter ending Oct. 31)		
Earnings	\$3,024,036	\$895,581
Sales	\$41,106,454	not given

Dividends

Allied Electric Products announced a quarterly dividend of 20¢ a share on common stock and 11¼¢ a share on preferred.

Cornell-Dubilier announced a 20¢ dividend on common stock and \$1.31¼ on preferred.

Allen B. Du Mont Labs., Inc., declared a 75¢ per share on common stock and 25¢ per share on preferred.

RCA gave a regular dividend of 50¢ a share and an extra dividend of 25¢ a share on common stock. A dividend of 87½¢ a share on preferred was also announced.

WHAT YOU GAIN WHEN YOU BUY...



LEADING TV SET MANUFACTURERS PICK HYTRON RECTANGULARS:
 ADMIRAL • AIR KING • BENDIX • CROSLY • EMERSON
 HALLICRAFTERS • HOFFMAN • MOTOROLA • NATIONAL
 OLYMPIC • SENTINEL • SETCHELL-CARLSON • SPARTON
 STROMBERG-CARLSON • TRAV-LER • WESTINGHOUSE
 AND OTHERS

HYTRON *Studio-Matched* RECTANGULARS

- 1 **You get THE ORIGINAL.** The *studio-matched* rectangular tube is Hytron's baby. Its logically designed screen matches the 4 by 3 aspect ratio of the studio picture. Quite naturally, Hytron's new rectangular is fast becoming the most popular picture tube.
- 2 **You get UNIFORMITY.** Hytron's new picture-tube plant is the most modern in the world. It was designed especially to mass-produce Hytron *studio-matched* rectangulars of uniform dependability.
- 3 **You get A COMPLETE LINE.** Hytron offers you 14-, 16-, 17-, and 20-inch *studio-matched* rectangulars. All the popular rectangulars (and the popular types of round tubes too).
- 4 **You get THE QUALITY LEADERS DEMAND.** Nine out of ten leading TV set makers choose Hytron. More and more leading service-dealers pick Hytron. Because their own experience proves Hytron *studio-matched* rectangulars give "amazingly clearer, sharper, more brilliant pictures." Demand this same performance for yourself. Demand original Hytron *studio-matched* rectangulars.

OLDEST MANUFACTURER OF RECEIVING TUBES
HYTRON
 RADIO AND ELECTRONICS CORP.



MAIN OFFICE: SALEM, MASSACHUSETTS

Money-maker with A Fast Pay-Off . . . Keeps Income Up When Sets Get Scarce



- 1. Fixed pole provides mount adaptable to all antenna rotors.
- 2. Top plate provides guy holes for easy guying.
- 3. New straight TXT eliminates bending under heavy stack load.

Mail Coupon
for
NEW Bulletin

Scarce sets aren't making scarce sales for dealers who push Teletowers! They're selling *improved reception* to present set-owners . . . and collecting a quick pay-off. Penn Teletowers and Thriftowers . . . advertised hard and merchandised hard . . . are now No. 1. on the "Hit Parade" of consumer tower acceptance.

NEW, cost-cutting engineering improvements are now incorporated in Teletowers. You're not up-to-date on your tower engineering until you've read Penn's new, free bulletin. Mail coupon or write today!

Penn Boiler & Burner Mfg. Corp., Dept. E
Lancaster, Pa.

Please send me free bulletin describing structural improvements in Teletowers and Thriftowers.

Name

Address

Canadian representative: J. R. McVITY & CO.,
53 Dalewood Road, Toronto, Ontario, Canada.

PENN Teletowers Thriftowers

PENN BOILER & BURNER MFG. CORP.
LANCASTER, PA.

Howard W. Sams & Co., Inc., declared a regular semiannual dividend of \$2.50 on preferred stock.

Sprague Electric Co. announced a quarterly dividend of 50¢ a share on common stock.

Show Notes

The 1951 Parts Distributors Show held a drawing for booth and display room space in New York on January 10th. The show will be held at the Stevens Hotel in Chicago on May 21-23.

The Pacific Electronic Exhibit show committees met in San Francisco to outline plans for the 7th annual exhibit which will be held at the San Francisco Civic Auditorium August 29-31.

The RTMA Parts Division executive committee passed a resolution favoring a single cooperative non-profit trade show in 1951 and thereafter.

Business Briefs

. . . The RTMA announced that ten new members, including one associate member, have joined the group. The new members are: Basler Electric Company, Keystone Electronics Co., Multi-Tron Laboratory, H. S. Martin & Company, The Radion Corp., Roburn Agencies, Inc., Sangamo Electric Co., Sheffco Manufacturing Co., Standard Electronics Corp. and The Turner Company.

. . . RCA Institutes announced that 235 students were graduated at the fall commencement exercises in New York City.

. . . Rinehart Books, Inc., Technical Division is the new name of the former Murray Hill Books, Inc., publisher of Ghirardi and other technical books.

. . . Howard W. Sams & Co., Inc., has announced that its Photofact Index is being expanded to include editorial and buyers' guide material for audio and TV service technicians. The index will now appear bimonthly.

. . . Philco Corp. signed a five-license agreement with the Hazeltine Corp., covering the use of its patent and engineering service.

. . . RCA Service Company announced a special service package which will offer purchasers of RCA Television Antenaplex Systems complete service coverage ranging from a preliminary survey to follow-up maintenance.

. . . Littelfuse, Inc., is now a participant in the engineering services of Howard W. Sams, Inc.

. . . NBC announced an accelerated program to prepare for coast-to-coast telecasting upon the completion of the microwave link, estimated at about January, 1952.

. . . RCA Tube Dept., equipment sales section, has issued a booklet to television receiver manufacturers describing custom-built test systems which provide complete facilities for mass-production test and alignment of television receivers.

. . . General Teleradio, Inc., tested the Skiatron Subscriber-Vision System over WOR-TV, New York. This pay-as-you-see system is transmitted entirely over the air without the use of telephone lines.

Never Before a Sales Boosting Campaign Like This—all for You!

This SYLVANIA star-studded program will keep your service business booming during 1951



It's ready and waiting for you now . . . the most colorful and appealing Service Dealer advertising campaign ever planned!

Featuring famous stars of screen, television and radio, it ties in with the national advertising your customers will see in *The Saturday Evening Post*, *Life*, *Look*, and *Collier's Magazine*, and with Sylvania's weekly CBS-TV Show, "Beat The Clock"!

So, win with Sylvania in '51. Send for this material NOW . . . and display it prominently. It identifies you as the expert with the super-fine Sylvania tubes . . . the tools and the know-how for the finest radio and TV service.

All of the display material, stickers and radio spots are FREE. You pay only 1¢ apiece for the four mailing pieces you send to your prospects. So, see your Sylvania Distributor or mail coupon NOW!

RADIO TUBES; TELEVISION PICTURE TUBES; ELECTRONIC PRODUCTS; ELECTRONIC TEST EQUIPMENT; FLUORESCENT TUBES, FIXTURES, SIGN TUBING, WIRING DEVICES; LIGHT BULBS; PHOTOLAMPS; TELEVISION SETS

SYLVANIA ELECTRIC

Sylvania Electric Products Inc.
Dept. R-4202, Emporium, Pa.

Please send me full details about Sylvania's great 1951 Dealer Promotion Campaign.

Name _____

Street _____

City _____ Zone _____ State _____

..this letter speaks for itself!

Admiral Corporation

SERVICE DIVISION
201 E. NORTH WATER STREET - CHICAGO 11 - TELEPHONE HOUSHE 4-4822

Mr. Mal Bushring
Simpson Electric Company
5200 West Kinzie Street
Chicago 44, Illinois

Dear Mal:

This is to tell you how delighted we are here at Admiral with the new Model 303 Simpson Vacuum Tube Volt-Ohmmeter. It certainly is a versatile instrument for television servicing.

The large meter is very legible, and yet the instrument itself is a compact size. I particularly like the AC voltage range, which is the widest I've ever seen on this type of instrument.

Our service engineers think you've done a good job on the Operator's Manual, too, because it is both complete and concise.

Of course, we've used the Simpson Model 260 Volt-Ohm-Milliammeter for years. The "303" is a fine companion instrument to the "260".

Congratulations!

Sincerely yours,

M. J. Schinke
ADMIRAL CORPORATION
M. J. Schinke
National Service Manager

MJStar

WORLD'S LARGEST MANUFACTURERS OF RADIO PHONOGRAPHS WITH AUTOMATIC RECORD
88-18 Radio • Television • Radio-Phonograph • Radiogram • Hi-Fi Records

Model 303 VACUUM TUBE VOLT-OHMMETER

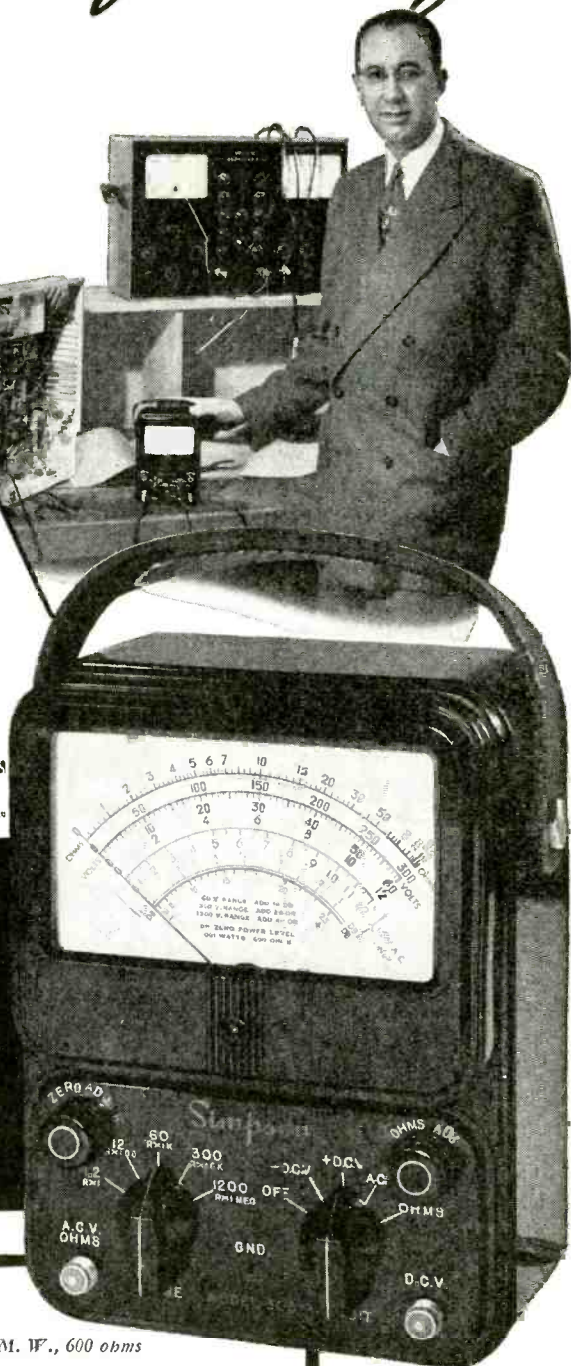

SPECIFICATIONS

DC Voltage

Ranges 1.2, 12, 60, 300, 1200 (30,000 with Accessory High Voltage Probe)

Input Resistance 10 megohms for all ranges

DC Probe with one megohm isolating resistor Polarity reversing switch

Ohms Ranges

1000 (10 ohms center)
100,000 (1000 ohms center)
1 megohm (10,000 ohms center)
10 megohms (100,000 ohms center)
1000 megohms (10 megohms center)

AC Voltage

Ranges 1.2, 12, 60, 300, 1200
Impedance (with cable) approx. 200 mmf shunted by 275,000 ohms

AF Voltage

Ranges 1.2, 12, 60
Frequency Response Flat to 100,000 cycles

Decibels

Ranges -20 to +3, -10 to +23, +1 to +37,
+18 to +51, +30 to +63

Zero Power Level 1 M. W., 600 ohms

Galvanometer

Zero center for FM discriminator alignment and other galvanometer applications

R. F. Voltage

(Signal tracing with Accessory High Frequency Crystal Probe)

Range 20 volts maximum
Frequency Flat 20 KC to 100 M.C.
105-125 V., 60 cycles

Size

5 1/2" x 7" x 3 1/8" (bakelite case). Weight: 4 lbs.
Shipping Wt.: 6 1/2 lbs.

Dealer's Net Price

Model 303, including DCV Probe, ACV-Ohms probe and Ground Lead—\$58.75;
Accessory High Frequency Probe, \$7.50;
Accessory High Voltage Probe, \$14.85
Also available with roll top case,
Model 303RT—\$66.70

Simpson ELECTRIC COMPANY

5200 WEST KINZIE STREET, CHICAGO 44, ILLINOIS • IN CANADA: BACH-SIMPSON, LTD., LONDON, ONTARIO

Phone: COLUMBUS 1-1221

RADIO-ELECTRONICS for

New SUPREME TELEVISION Manuals

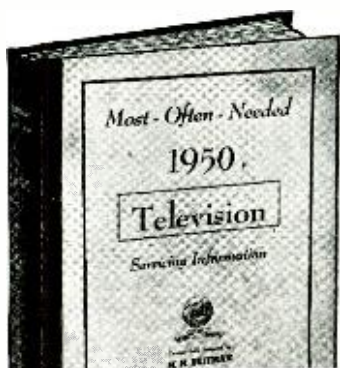

New 1950 Television Manual

This newest giant volume of the series covers 1950 factory data on all popular television sets of all makes. There are circuit explanations, 114 pages of alignment procedure, test patterns, response curves, pages of waveforms, voltage charts, service hints, and ten mammoth 11x15" blueprints. Manual \$3 style binding. Price postpaid, only....

1949 T-V Manual. Similar to the volume listed above. Has 160 extra-large pages, plus 9 double-spread giant blueprints. To order see coupon below, only..... \$3

1948 T-V Manual. Earlier volume has material on all popular T-V sets of this period. Large size, 8 1/2 x 11". Remarkable value. \$3 Including 8 fold-out blueprints, only....

1947 FM and T-V Manual. Covers all needed FM and television sets including popular R.C.A. 630TS. Data on 192 pages. Only..... \$2

INCLUDES ALL POPULAR SETS

All you need to service any television set are the four SUPREME TV manuals described at left. Every popular television set, from the early 1947 models to the very latest 1950 receivers, are here. Covered in great detail making adjustment and servicing really easy. Manuals have data on circuits, alignment, test patterns, response curves, service hints, voltage charts, waveforms, factory recommended changes, and many mammoth 11 x 15-inch blueprints. These manuals will give you the practical know-how of a TV expert and will repay for themselves with time saved on a single TV job.

AMAZING BARGAIN OFFER

The television series manuals are the most remarkable values offered by Supreme Publications in their 17 years of business. These TV manuals at only \$3 and \$2 each are amazing bargains and defy competition. There is nothing else like them. Each manual is a virtual treatise on practical television repairs. By normal standards, each such large manual packed as it is with practical facts, hundreds of illustrations, diagrams, charts, photographs, and expensive extra-large blueprints, should sell for \$10—but as SUPREME special values they are priced at \$3 and \$2 each. Only a publisher who sold over one million TV and radio manuals can offer such bargains based on tremendous volume-sales.

FIND—FIX ALL T-V FAULTS

Use these timely television manuals as your guide to quick fault finding and repair of any television set. Eliminates guesswork—tells you just where to look and what to do. Cuts hour-wasting jobs to pleasant moments. Use test patterns for quick adjustment, or look up probable cause of trouble in the pages of hints after simply observing fault in video picture. No equipment needed with these tests. Or use your voltmeter and compare values with many voltage charts included. With an oscilloscope you can get waveforms similar to hundreds illustrated using test points suggested and in a flash locate what used-to-be a hard-to-find fault. Order at our risk for a 10-day trial. Use coupon at bottom of page.

YOURS TO USE ON TRIAL

Decide to have in your shop all four Television Manuals as described in the first column at the left. Or try the new 1950 TV manual to see what an amazing bargain you get for only \$3. Order on no-risk trial by using coupon at bottom of page.

RADIO-ELECTRONICS HOME-STUDY COURSE



ONLY \$3.95 COMPLETE 3 VOLUMES 53 Lessons

NEW AMAZING OFFER

Here is the most amazing bargain in radio training. The price scoop of the year. For only \$3.95 (full price) you receive a complete radio-electronics course of 53 large, fact-packed lessons. Covers every topic of radio. Published in three giant books, bound in one super-mammoth volume. Printed in 1951. Compares lesson by lesson with the best \$200 home-study correspondence courses; but here you get all lessons at one time at the unheard of bargain price of only \$3.95, nothing further to pay or buy.

COMPLETE TRAINING IN RADIO-ELECTRONICS

The complete training of the 53 large lessons is really three distinct courses covering (1) Practical Radio, (2) Applied Electronics, and (3) Radio Servicing. The lessons are clear, practical, easy to master and use. Early lessons will make fundamentals clear even to a beginner, while other lessons will give you the practical "know-how" of an expert. Notice in the illustration of the manuals, at top, that the wide column on each page has the text, while the narrow column contains pertinent explanations usually supplied by a teacher. These teacher comments guide you over the hard parts, stress points of importance, tell you how to perform practical experiments using any home radio. There are hundreds of review self-testing questions, 427 drawings, pictures, diagrams, and over a thousand service hints. The most complete 3-in-1 volume in radio-electronics for home-study.

YOURS TO TRY FOR 10 DAYS



Edited by M. N. Beitman, radio engineer, teacher, author & serviceman.

Just send no-risk coupon, at right, and receive the 3-volume Course for a free examination. Use all this material a full 10 days in your own home. Read a few lessons, examine the hundreds of illustrations, apply some of the hints to fix a couple of radios. Only then, if you are pleased, the complete course of 53 lessons, in three volumes, is yours to keep for only \$3.95, full price; otherwise, it costs you nothing for the examination. Fair enough? Please rush coupon while your special price for all 53 lessons is still only..... **\$3.95**

Supreme Publications

Sold by All Leading Radio Jobbers

FEBRUARY, 1951

SUPREME RADIO MANUALS

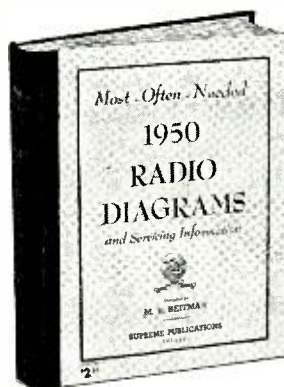

New 1950 Radio Diagrams

Now you can benefit and save money with Supreme amazing scoop of 1950. This one giant volume has all the service data you need on all recent radio sets. Here you have clearly-printed large schematics, needed alignment data, parts lists, voltage values, and information on stage gain, location of trimmers, and dial stringing illustrations. This is the help you need to find tough faults in a jiffy. The new 1950 radio manual is a worthy companion to the 9 previous volumes used to an advantage by over 128,000 shrewd radio men.

BIGGEST BARGAIN IN SERVICE DATA

Wise servicemen know that Supreme Publications manuals have all the material needed at the lowest prices. For the remarkable bargain price (only \$2 for most volumes) you are assured of having on hand needed diagrams and all other essential repair facts on almost all sets you will ever service. Every popular radio of all makes, from old-timers to new 1950 sets is covered. Select manuals wanted, see list below, and rush no-risk order coupon.

SUPREME RADIO MANUALS for PREVIOUS YEARS



1949 1948 1947 1946 1942 1941 1940 1939 1926-1938
SUPREME Most-Often Needed RADIO DIAGRAMS Each Manual only \$2. (1949 is \$2.50; 192 pages of diagrams, alignment data, voltage values, parts lists, and service hints; large size, 8 1/2" x 11". To order, see coupon below.

RADIO Diagrams 240 Pages Price \$2.50

NO-RISK TRIAL ORDER COUPON

SUPREME PUBLICATIONS, 3727 W. 13 St., Chicago 23, ILL.

Send on trial manuals checked below and at right. You guarantee complete satisfaction.

- 1950 Television Manual, \$3. 1949 TV, \$3.
- 1948 TV, \$3. 1947 TV & FM, only \$2.
- Practical Radio & Electronics Course, only... \$3.95
- I am enclosing \$..... Send postpaid.
- Send C.O.D. I am enclosing \$... deposit.

Radio Diagram Manuals

- New 1950 Manual, \$2.50
- 1949 Radio Manual, \$2.50
- 1948
- 1947
- 1946
- 1942
- 1941
- 1940
- 1939
- 1926-1938 Manual, \$2.50

PRICED AT ONLY \$2 EACH

Name:

Address:

EICO KITS
and INSTRUMENTS

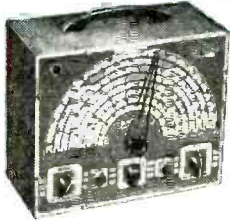

320K SIG. GEN. KIT \$19.95
Wired \$25.95

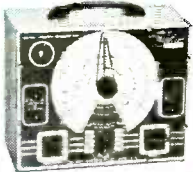

New 950F COND.-RES. COMP. BRIDGE KIT \$9.95
Wired \$29.95

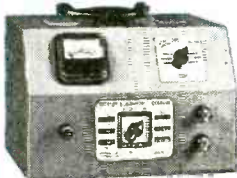

New 10-CK BATTERY ELIM. KIT \$25.95
Wired \$34.95



511K CM KIT \$14.95
Wired \$17.95

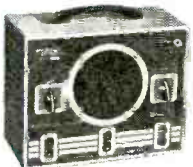

145K SIG. TRACER KIT \$19.95
Wired \$28.95



HV PROBE
(Wired only) \$6.95



RF PROBE KIT \$3.75
Wired \$5.95



0.5 SMC CRYSTAL
\$3.95

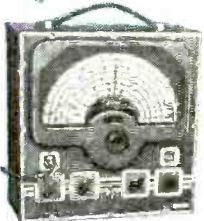

New 315M DELUXE SIG. GEN. KIT \$39.95
Wired \$59.95



Harry R. Ashley, President of EICO, inspecting the use of the EICO Model 425 Oscilloscope and Model 221 Vacuum Tube Voltmeter at one of the important alignment positions on the Emerson television production line, New York plant.

For Laboratory Precision at Lowest Cost—the Leaders Look to EICO!

FOR electronics test equipment, there's no tougher proving ground than the factories where TV sets are made. There's where the pace is fastest, precision requirements the highest, costs the tightest—and day-after-day dependability an absolute *must*.

In both the giant New York and New Jersey television plants of the Emerson Radio & Phonograph Corporation — at the many critical constant-duty testing positions along the production line—EICO instruments stand guard. For Emerson has found that for speed, accuracy and trustworthiness, at lowest cost, EICO instruments always deliver the fullest measure of value.

From coast to coast, in one leading TV factory after another, this is the experience—*this is the proof of EICO superiority*—that is repeated again and again. The top-flight TV set makers have discovered—and over 50,000 servicemen have learned—that *for the industry's greatest instrument values, at the industry's lowest costs—it's EICO!*

Be sure you look at the *EICO* line *before you buy any higher-priced equipment!* Each *EICO* product is jam-packed with unbelievable value. *YOU* be the judge—compare *EICO* at your local jobber today—and *SAVE!* Write *NOW* for free newest Catalog 2-C.



New 221F TVM KIT \$25.95
Wired \$49.95



New 425K 5" SCOPE KIT \$44.95
Wired \$79.95



New 625K TUBE TESTER KIT \$34.95
Wired \$49.95

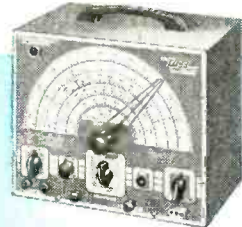

360K SWEEP GEN. KIT \$34.95
Wired \$49.95



ELECTRONIC INSTRUMENT CO., Inc.
276 NEWPORT STREET, BROOKLYN 12, NEW YORK

© 1950, Electronic Instrument Co., Inc.

Prices 5% higher on West Coast. Due to unsettled conditions, prices and specifications are subject to change without notice.

War Radio-Electronics

. . . *Radio-electronics is THE key to modern warfare* . . .

By HUGO GERNSBACK

WORLD WAR II was won by the Western Powers in a large measure through the applications of radio and its allied arts. World War III will be won by that side which knows how to apply the science of radio-electronics to the utmost degree.

The above conclusions will not be seriously questioned by anyone who has studied modern warfare intensively. Mechanized war today cannot possibly function without the application of radio-electronics and while its methods may change from one war to the next the basic principles always remain the same.

Our reverses of last December in Korea did not present any new ideas of warfare. Many newspaper articles stressed the point that the "new" infiltration tactics of the Chinese Reds were something entirely unprecedented. This is unadulterated nonsense. The tactics may have been new to our present G.I.'s, but infiltration tactics have been used since the dawn of humanity.

Even in the United States the American Indians were past masters of infiltration tactics and perhaps they could have taught the modern Chinese a few ideas of their own. The silent approach during the night when the Indians cut the throats of our soldiers or scalped them by stealthy approach from the rear certainly is hoary with age. It is new only in that our present-day soldiers had not been trained in this rugged and primitive type of warfare.

There is, however, no good reason to believe that in any large-scale war these tactics will prove effective against us. Any qualified radio engineer can immediately suggest a dozen different ideas to circumvent infiltration. Indeed, during our war with Japan when the Japanese used the identical infiltration tactics, we countered them with our electronic snooperscopes and similar devices.

Here we made use of infra-red rays to discover the crawling enemy in the dark. In the next war we will use similar devices as well as others, such as electronic body capacity effects. For example wires can be stretched on the ground so that any moving object which comes near the wire will alarm our forces.

In the air war we now have better and more sensitive radar devices which will be still more improved, particularly in weight reduction. Here, too, a host of new guided weapons will make the fighter plane as well as the bomber much more formidable weapons than they were in World War II. Because of guided weapons and automatic sighting devices the aerial gunners no longer have to rely on their own marksmanship. In

modern war where planes fly at supersonic speeds no man can aim a gun effectively. Human reactions are now far too slow. For this reason radio-electronics takes over the shooting in the modern jet fighters while the guided missiles find the enemy plane automatically. This is one of the chief reasons why the best radio-electronic equipped air force is certain to win the war in the air.

It is radio-electronics too that will protect our cities from enemy bombers. From the air as well as from the ground guided weapons are the answer to enemy invading air fleets. *Long distance* radar alerts will coordinate the home defending forces—whether in the air or on the ground—by radio-electronics to such a degree that once our defense net is built and completed, few enemy bombers will get through to their targets.

Unfortunately such defense nets have as yet not been installed in the United States, but it will not be very long before we will be ready on a large scale.

The next great menace is the enemy submarine, particularly the large Schnörkel type which carries bombing planes which can take off from the deck. We have good reason to believe that such submarines are being planned or built by the Russians even now.

Nor is there anything new about that. Indeed, at the beginning of World War I there was a great deal of talk of German submarines getting ready to bomb or shell New York.

In one of our former magazines, *THE ELECTRICAL EXPERIMENTER*, such a submarine was pictured on the front cover of the July 1918 issue. That the German aircraft-carrying submarine did not materialize in World War I nor World War II, means only that technical know-how was insufficient to produce such a submarine. But this is definitely not the case today.

We have now a number of excellent new radio-electronics devices to counter the submarine. These are being further perfected and we believe that the answer to the submarine has been found. It will soon become increasingly difficult for any enemy submarine to produce large scale shipping havoc, as did the Nazis' submarines during World War II.

Despite our superior technical achievements we must not become complacent for a moment and underestimate our chief opponents—the Russians. This might well be fatal for us. The Russians today have excellent war matériel in all classes including radio-electronics and they are getting better all the time. We must therefore outperform and outproduce them speedily if we are to survive. This will require all our ingenuity, all our resourcefulness and all our strength.



By SAMUEL FREEDMAN

OMNIRANGE aircraft navigation will make air travel safe, dependable, and predictable regardless of visibility, weather, and volume of air traffic. A major innovation in air navigation, the omnirange will require about fifteen years and \$1,500,000,000 for installation throughout the country.

The Civil Aeronautics Administration and equipment manufacturers are cooperating to carry out the recommendations of the Radio Technical Committee and the Air Navigation Development Board for this program. The Air Navigation Board is headed by repre-

stations and other aircraft. The same receiver also receives voice signals from the ground during a ground-controlled-approach landing operation.

The omnirange indicates direction be-

supply is located in the house adjacent to the antenna tower.

The ground omnirange transmitter radiates two radio signals which add together to form a single signal at the

FIELD FROM PAIR N°2 WHEN PAIR N°1 IS ZERO

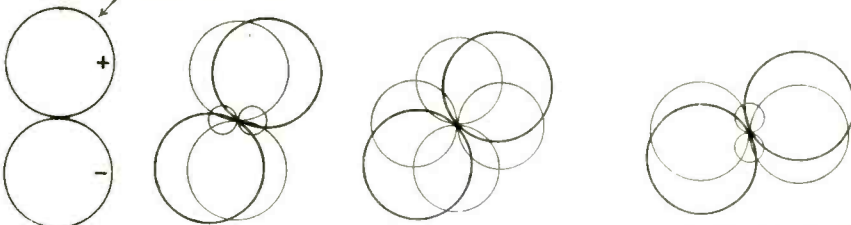

FIELD FROM PAIR N°1 WHEN PAIR N°2 IS ZERO

Fig. 2—The two fields produced by the antenna pairs add together to produce a rotating figure eight pattern.

cause the v.h.f. receiver picks up signals of a certain phase relationship for a given angle from the transmitter. A converter unit transforms this phase relationship into an infinite number of courses with respect to each ground station. The aircraft can use the omnirange no matter what angle it bears and whatever its location. With the previous range systems on lower frequencies, a plane could "fly the range" only along one of the four beams or legs of a ground station. These are only 3 degrees wide. Instead of a total of 12 degrees of range coverage in a total of 360 degrees, the omnirange covers 360 degrees for every ground station.

The ground station

Fig. 1 illustrates a typical ground omnirange station spotted to have minimum distortion or error due to the topography of the earth. A circular ground plane is atop the antenna tower. A housing transparent to radio signals protects the antennas. The transmitter with its automatic emergency power

receiving point, normally on an aircraft.

One of the two signals radiated is nondirectional. The other is a rotating field comprising two figure-eight directive patterns at right angles to each other and derived from a single signal source over two pairs of antennas. A split capacitor rotated by a motor driven at 1,800 r.p.m. varies the voltage fed to the antenna pairs at a sinusoidal rate of 30 cycles per second. The two figure-eight radiation patterns add together at each instant through a full 360 degrees to form a new figure-eight pattern as shown in Fig. 2. The non-directional field pattern from an additional antenna is superimposed on this rotating figure eight to produce the resultant pattern shown in Fig. 3. The sum of the rotating and nondirectional fields result in a rotating cardioid radiation pattern. Because this field rotates, the signal strength at any receiving point varies at the rate of 30 cycles per second (corresponding to the motor rotation of 1,800 r.p.m.). It is called the VARIABLE (V) voltage. The nondirectional antenna transmits another signal containing a fixed modulation or tone of 30 cycles which is called the REFERENCE (R) voltage. The variable voltage is compared with the reference voltage to provide a measure of the bearing of the airborne omni-receiver (the aircraft itself) from the ground station with respect to magnetic north or zero bearing. A different phase angle exists between the reference and the variable voltage for every

Courtesy Bendix Radio



Courtesy C.A.A.

Fig. 1—A typical omnirange station as the birds see it. The antenna rotating gear is in the shelter atop the mast.

sentatives from the CAA and the Army, Navy, and Air Forces. The Radio Technical Committee for Aeronautics includes delegates from manufacturers, air transport associations, airlines, pilot associations, and similar organizations.

Enroute, the pilot can fly any desired track within range of the ground transmitters strategically located throughout the United States. When approaching an airport preparatory to landing, the aircraft aligns itself perfectly with the runways for a v.h.f. localizer approach with the same equipment. The system uses the v.h.f. communication receiver of the aircraft that also serves for two-way voice communication with ground

change in direction between the airborne receiver and the ground omnirange transmitter as shown in Fig. 4.

The aircraft installation

Fig. 5 shows the controls or instruments used by the pilot in an aircraft for omnirange operation.

1. Remote control unit for selecting the correct frequency of a tunable or present receiver.

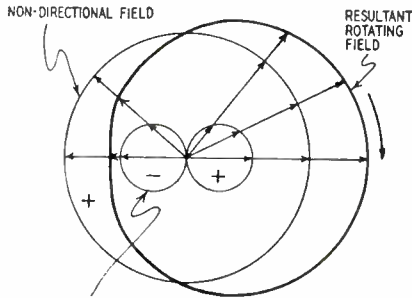

FIGURE 8 ROTATING FIELD



Courtesy Bendix Radio

Fig. 3—The resultant of the fixed and rotating fields is a rotating cardioid.

2. Course selector for the course that the pilot wishes to follow.
3. Cross-pointer meter or deviation indicator so pilot can determine what maneuvers to make to stay on course.
4. To-from meter to indicate whether the station he is tuned to is toward or from his location. He can work with a station behind as easily as with a station ahead so long as the correct 180-degree side is used in laying out his course.

Besides these controls and instruments, the aircraft installation contains a receiver, a converter unit, and power supplies. The receiver is a nine-tube AM superheterodyne tunable from 108 to 135 mc.

Fig. 6 is a block diagram of the converter unit. It can function only on the omnirange signals coming out of the v.h.f. receiver. This unit takes the complex audio-frequency signal voltage from the receiver and converts it so that the bearing of the receiving antenna (on the aircraft) can be determined with respect to the transmitting antenna (at the ground omnirange station).

The a.f. signal consists of two independent components. One is the reference channel signal. This is 9,960 cycles per second, frequency-modulated (changed in frequency) at a 30-cycle-per-second rate to 480 cycles per second above and below 9,960. In practice, a round figure of 10 kilocycles is used in mentioning the 9,960-cycle signal and it is referred to as the "10-kilocycle channel." After this signal passes through a filter, a limiter provides a uniform signal by limiting the maximum values which signals can attain. This is followed by a discriminator which converts changes of frequency into changes in voltage. This derives the REFERENCE 30 cycle-per-second voltage. Its phase is independent of the

bearing of the transmitter.

The other one is 30 cycles per second (variable-channel signal) whose phase in space at any given instant is a function of the bearing from the transmitter. This 30-cycle VARIABLE amplitude modulation is in phase with 30-cycle frequency modulation of the 10-kilocycle channel when the receiving antenna bears zero degrees from magnetic north. At every other point around the ground transmitter, the two 30-cycle voltages differ in phase by an amount up to 360 degrees, which can be read on the course selector as a bearing to or from the omni-station.

In the block diagram (Fig. 6), the a.f. output signal from the receiver is filtered to separate the 10-kc and 30-cycle components. A highpass filter passes the 10 kc as indicated on the right side of the block diagram, while a lowpass filter passes the 30 cycles as indicated on the left side of the same diagram.

On the 10-kc side, an additional 10-kc filter is provided after the discrimi-

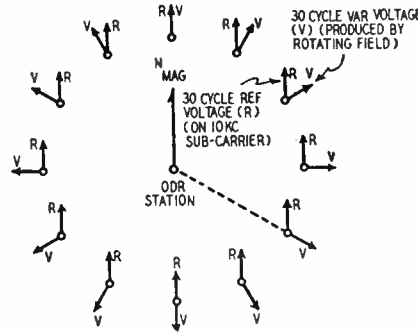

Courtesy Bendix Radio

Fig. 4—Each point on the compass has a different phase angle between the reference (R) and variable (V) signals.

nator to eliminate residual 10 kc which might still be present at that point. It passes through an audio-frequency amplifier and thence to another a.f. amplifier as well as through a resistance-capacitance network to shift the phase approximately 90 electrical degrees to an audio amplifier. One amplifier goes through an a.f. transformer to a wattmeter circuit comprising the cross-pointer meter while the other amplifier goes through another a.f. transformer to a wattmeter circuit comprising the to-from meter.

In the 30-cycle leg of Fig. 6, the output of the a.f. amplifier goes through a lowpass filter and thence to a phase-splitting network which produces a 30-cycle input to two a.f. amplifier tubes that are functioning 90 electrical degrees apart. A circuit from each of the two tubes contains one primary of the course selector (CUS SEL. PR. NO. 1 AND PR. NO. 2) while the secondary of the course selector (CUS SEL. SEC) has a voltage induced in it whose phase depends on its angular setting and whose magnitude is determined by the voltage at the input to the phase splitter.

In the PHASE-LOC (phase-localizer) switch position, the phase and amplitude of the voltage applied to a tube are

those required to give zero current in the cross-pointer meter when the receiving antenna on the plane is in the center of the runway receiving only REFERENCE voltage. On either side of on-course, a signal arrives through the VARIABLE channel which is either in phase or 180 degrees out of phase with respect to the reference voltage. The result is a motion of the needle to left or right of center as the two signals are in or out of phase. The phase-localizer function, designed for blind landing, is no longer in use.

Flying the omnirange

Using the equipment is simplicity itself. In the words of a very clearly written CAA nontechnical booklet "Flying the Omnirange."

Let us suppose that the pilot decides to fly to a particular city. First, he looks at a recent aeronautical chart, which shows the frequency and location of each omnirange. He then selects an omnirange close to where he is going, and tunes it in on the proper frequency. To be sure he has the correct range, he listens with ear-phones to the identification, sent out either in Morse code or by voice recording.

Next, he turns his BEARING SELECTOR until the vertical needle centers at the bottom of the round dial. He glances at the TO-FROM indicator to be sure the bearing is TO the omnirange. If it should be FROM, he merely turns the bearing selector 180 degrees, at which point the indication will become TO.

All that he then has to do is to fly a course which will keep the vertical needle centered. If it moves right, the pilot flies right to correct his course. If it moves left, he turns the plane slightly left until the needle is centered.

That is all there is to it. If he keeps the needle centered, he will fly directly over the omnirange. At that point, the TO-FROM needle will flicker for a few seconds, then change to a FROM indication. If the pilot desires to continue in the same direction, he merely continues to keep the needle centered.

Nothing has been mentioned about correction for wind drift or correction for magnetic variation because by using the omnirange there is no need for correction. Keeping that vertical needle centered automatically "crabs" the plane into the wind just the right amount to fly a straight-line course to the omnirange. Magnetic variation is corrected in the omnirange itself—all its courses are in terms of the local magnetic field.

New developments

The omnirange program as described in this article is the first of three initial phases of the postwar aviation navigational radio aid program. Many devices are now in development and in produc-

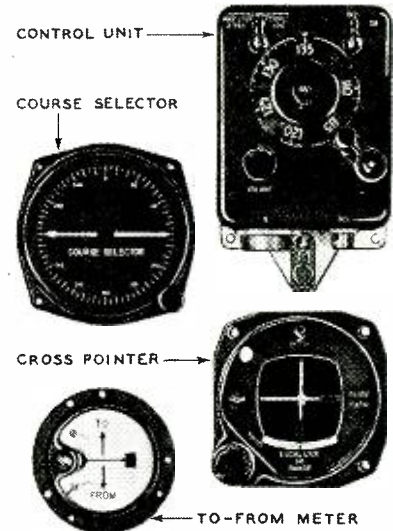

Courtesy Aircraft Radio Corp.

Fig. 5—The pilot's control instruments.

tion for early widespread adoption by major aircraft. Simplified forms are being developed for private aircraft. The navigational computer, also known

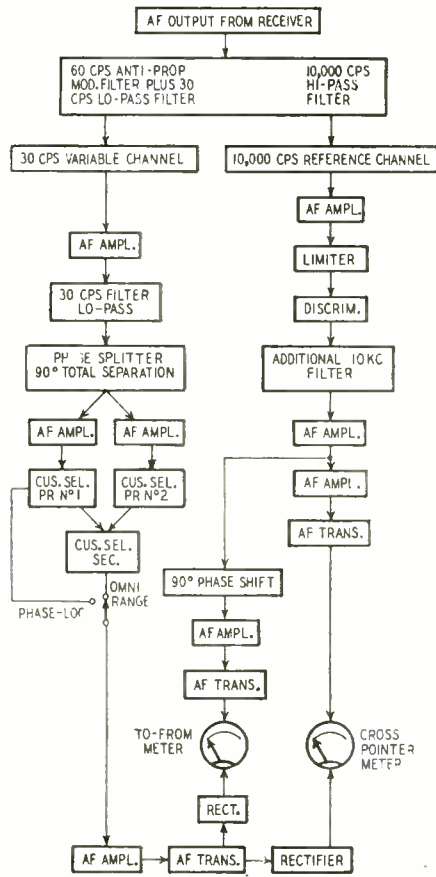

Courtesy Aircraft Radio Corp.

Fig. 6—Block diagram of the converter.

as the R-Theta computer, uses two or more omnirange stations simultaneously to provide constant and automatic

fixes for an aircraft at all times. DME or distance-measuring equipment operating on 1,000 megacycles is now under heavy initial production with some \$20,000,000 of equipment ordered for the ground stations. DME will show the pilot the exact distance or number of miles he is to or from an omnirange, DME-equipped ground point.

To make simplified, light, low-cost equipment available, the CAA has sponsored initial procurement contracts to absorb the development cost so that plane owners can buy such equipment on the basis of production cost alone. In competitive bidding, such a contract was awarded by CAA to the National Aeronautical Corp. of Ambler, Pa., which has developed the equipment shown in Fig. 7. The components are:

1. Receiver using seven tubes and continuously tunable from 108 to 122 mc as required for omni- and two-way radio reception. The weight is 2 pounds.
2. Transmitter for two-way voice communication. It weighs 22 ounces, has six crystal-controlled channels, and an output of 3/4 watt.
3. Omni-converter.

Other manufacturers are also developing receiving equipment for putting the entire system into one compact cabinet or panel for dash mounting. In the costlier and larger systems, up to 280 crystal-controlled, automatically selected channels can be selected for communication and navigation.

Whenever a ground omnirange station is so situated with respect to terrain conditions that errors exceeding 3 degrees take place in aircraft, the CAA has made local constructional changes or even moved the entire omnirange station to a more reliable location. The need to do this has been minimized by extensive field tests with portable omnirange ground stations in advance.

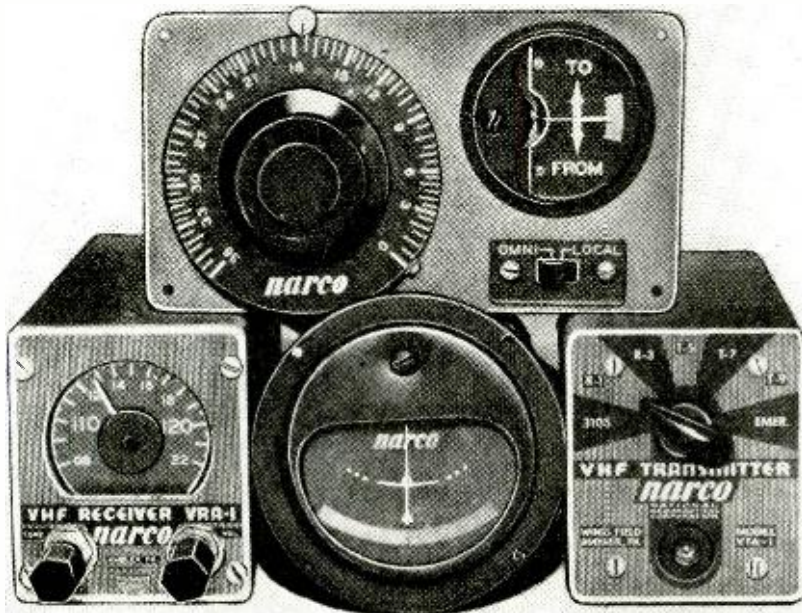

Courtesy National Aeronautical Corp.

Fig. 7—Omnirange receiving equipment in miniature built for small aircraft.

TUBES OF THE MONTH

A ruggedized subminiature, announced by National Union, is one of this month's new tubes. The tube, a beam power output pentode, is designated the 5851, and is for military and other uses where the tube is subjected to unusual shock and vibration. It is suitable for frequency doubler operation up to 400 mc, producing 120 milliwatts. The filament needs only 55 ma at 2 1/2 volts, and can also be operated at 1 1/4 volts and 110 ma.



The 5851 is built into a T-3 envelope and has a plate dissipation rating of 1 1/2 watts. As a class-A amplifier, it will deliver 650 milliwatts audio output at 10% harmonic distortion. Designed and tested for shock at 500 g, the 5851 may be soldered directly into the circuit, or may be used with a standard subminiature socket.

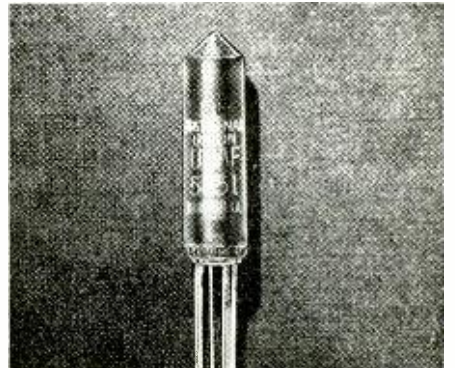

When used as a frequency doubler with an output frequency of 400 mc, typical operating conditions for the 5851 are: 125 volts on both plate and screen; 350,000 ohms resistance in the grid circuit; 8 ma plate current; and screen current of 2 ma. Output under these conditions is 120 mw.

Now being delivered to manufacturers as original equipment for TV receivers and to jobbers as a conversion item is Du Mont's new 20CP4 Teletron, a 20-inch rectangular kinescope which features a bent-gun design and a dark face-plate to improve contrast and reduce stray reflections.

Other characteristics of the 20CP4 are: over-all length, 21 1/16 inches; screen size, 17 x 12 3/4 inches; deflection angle, 70°; heater, 6.3 volts at 0.6 amp; maximum anode voltage, 18 kv. The ion trap requires a 52-gauss magnet at 14 kv anode potential.

Maximum grid No. 2 rating for the 20CP4 is 410 volts; grid No. 1 values are: negative bias, 125 volts, positive bias 0 volts, and peak positive bias, 2 volts.

G-E has announced that it will also begin production on this 20-inch tube soon.

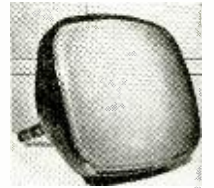

20CP4 kinescope.

Engineered Amplifier Brings Audio Realism

By
A. W. FITE,
C. E. HABLUTZEL,
E. D. NUTTALL

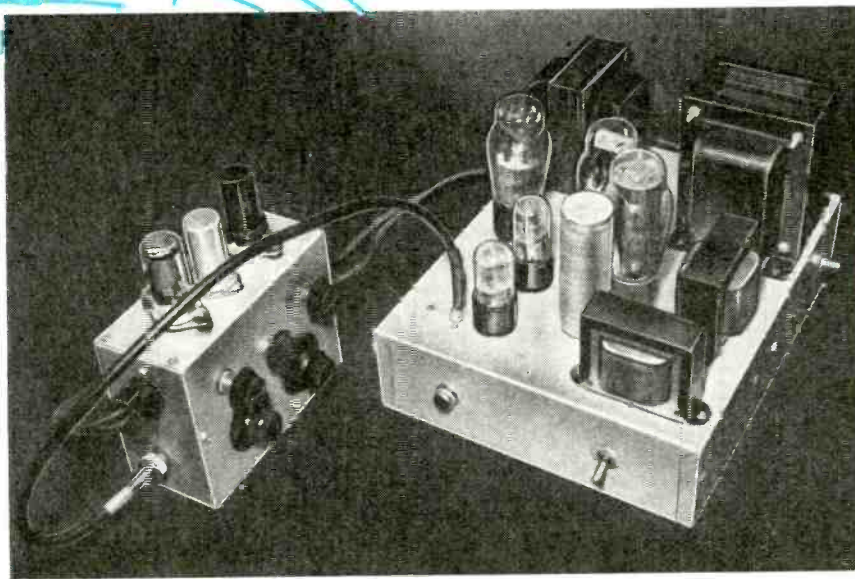

Fig. 1—View of the two-chassis model of the all-triode amplifier. All the controls on this model are conveniently located on the preamplifier chassis.

THE genuine music lover who wishes to hear music as it would sound were he listening to the actual performance will find in this amplifier an approach to that ideal. At the same time it has sufficient flexibility to permit variation of frequency response to suit the individual ear and to compensate for the falling off of high- and low-frequency response which is inherent in some components of the complete sound system.

A number of intangibles go into the construction of an amplifier. Proper balance of highs and lows, correct time intervals for transients and elimination of undesirable transients, adequate power for peaks and good low-frequency response without distortion, and correct coupling to the loudspeaker are a few important points which frequently are neglected. This neglect leads to the difficult to describe but very real sensation known as listener fatigue—a phenomenon not limited to low-priced equipment.

The advantages of having the pre-amplifier and controls in a separate chassis are many. However, this leads to greater complexity and cost. We describe here two forms of the basic amplifier, a deluxe model on two chassis and a utility model on one chassis. Although both give excellent results, the two-chassis model has a number of additional refinements.

Fig. 1 and Fig. 2 are top and bottom views of the two-chassis model, and

Fig. 3 and Fig. 4 give the schematics of the preamplifier and amplifier. The preamplifier, of course, can be used with any amplifier which can supply the required power.

In addition to having the necessary gain for a magnetic phonograph cartridge, the preamplifier has bass, treble, and loudness controls. Also, a four-position switch, S1, is provided to compensate for the different types of high-

frequency pre-emphasis used by the different record manufacturers. Position 1 gives nearly flat response, and will over-emphasize the highs on most records with the possible exception of some 78-r.p.m. foreign discs. Position 2 is best for most 78-r.p.m. records unless scratch requires the use of positions 3 or 4, and also is best for Victor and Capital LP's. Position 3 provides compensation for Columbia and other LP's.

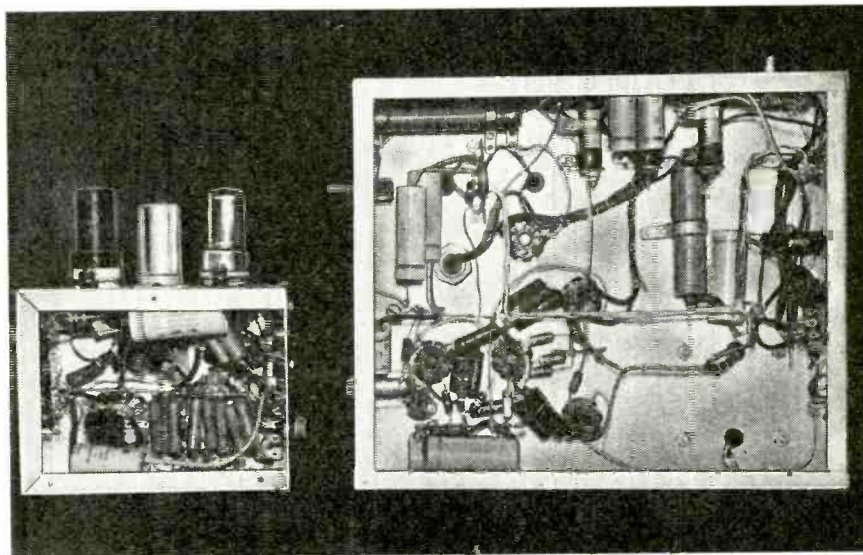

Fig. 2—Bottom view of the amplifier. A spacious chassis permits a tidy wiring job in the main amplifier. One-point grounding is used in both the chassis.

Construction hints

There is nothing critical about constructing this amplifier, as we have proven over a period of time from the several previously built. To insure plenty of room, a 3 x 5 x 7-inch chassis is advisable for the preamplifier and a 3 x 10 x 12-inch chassis for the amplifier. We do not recommend cabling together wires which carry signal currents, nor do we recommend placing components which carry signal voltages on a common terminal strip.

Locate the tube sockets so that coupling capacitors can be placed with short leads from tube terminal to tube terminal. Supply B-plus voltage from a common bus or terminal strip located along one side of the socket layout through the load resistors directly to the socket terminals. Along the other side of the socket layout place a common ground bus to which appropriate connections can be made. Connect this ground bus to the chassis at only one point and locate this point as close to the signal input terminal as possible. In the two-chassis model the one-point grounding procedure should be followed in both preamplifier and amplifier to avoid chassis current effects.

Resistor R8 gets rather hot. Attach it to the side of the chassis at both ends and bore ventilating holes along the side of the chassis both above and below this resistor.

From the preamplifier to the main amplifier chassis filament ground and signal ground are carried separately and connected together at the main amplifier ground bus.

The 12SC7 and 14AF7 tubes in the preamplifier should be shock-mounted. In the utility model the 6SC7 should be shock mounted.

In the utility model, a chassis bottom plate helps to cut down direct hum pickup by the compensating network which comprises the input to the 6SC7. It is best to operate the 6SC7 and the 6J5 from a separate filament winding or transformer to reduce hum.

Adjustments

Adjustments must be made in the two-chassis model so that the current to each 6B4-G tube is 40 ma and the current to the preamplifier filaments is between 140 and 150 ma.

Adjust R7 to 400 ohms and R8 to about 7,000 ohms. Measure the current in the plate circuit of each 6B4-G individually, and by adjusting R9 and R10 balance these two currents at any convenient value between 40 and 50 ma. Then adjust R8 until the voltage between terminals 1 and 4 on the power socket to the preamplifier measures 22 to 24 volts. Next recheck the 6B4 plate current and by means of R9 and R10 adjust to 40 ma each. Again check the filament voltage to the preamplifier and adjust R8 to make this voltage 23 to 24 volts. Repeat the resistor adjustments if necessary until the proper currents and voltage are obtained. Normally R7 is left at 400 ohms. Its value can be changed somewhat if nec-

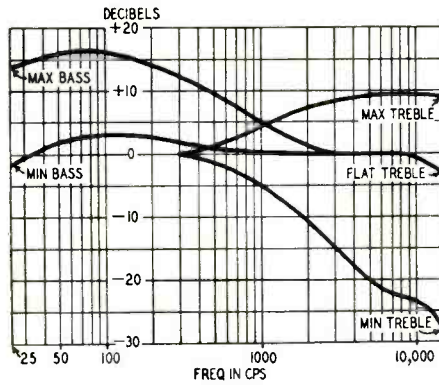

Fig. 5—The frequency response curves showing the effect of the tone controls.



Fig. 6—Photo of the one-chassis unit.

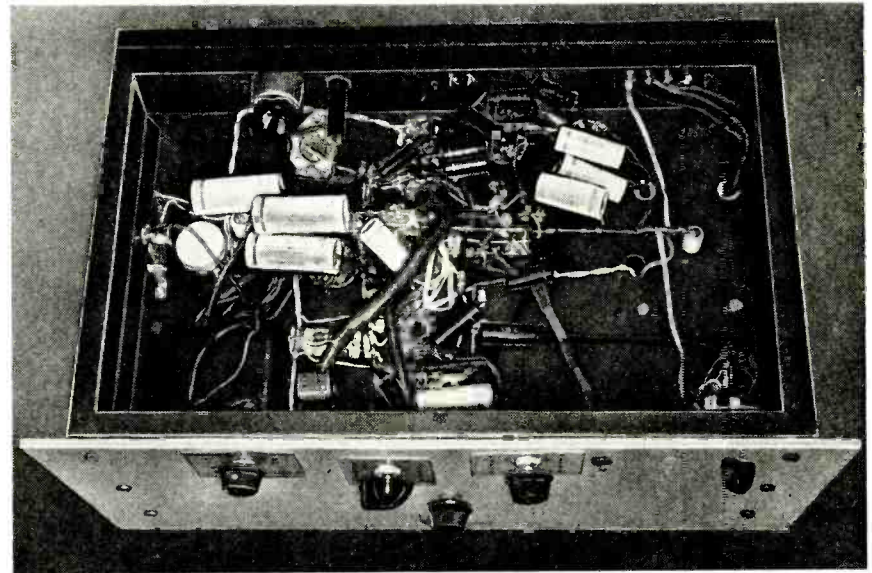

Fig. 7—Underside of the one-chassis unit. It is built on a surplus chassis.

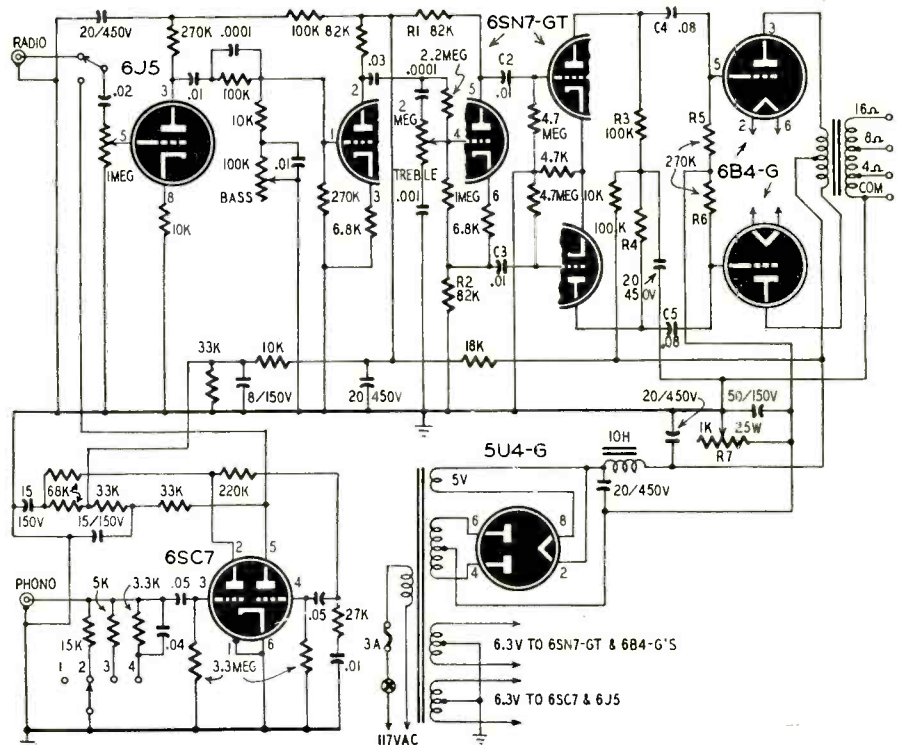

Fig. 8—Complete circuit of the one-chassis version of the triode amplifier.

Electronics and Music



This is one of twelve similar chassis which make up the tone generators of an instrument the author is constructing. A Wien-bridge oscillator syncs 6 lower-octave neon tube oscillators.

Part VIII—More on tone oscillators

By RICHARD H. DORF*

IN PART VII of this series we discussed the basic feedback-type vacuum-tube oscillators suitable for polyphonic electronic musical instruments. This month we turn to negative-resistance and resistance-capacitance oscillators.

Negative resistance is easily visualized as a circuit property which exactly disobeys Ohm's law. Such disobedience is not quite the heresy it seems, for it takes place only in a figurative sense under special conditions.

The primary example of the negative-resistance oscillator is the dynatron, first developed by A. W. Hull many years ago. It employs a tetrode tube in the circuit of Fig. 1. The grid is grounded for a.c. and the screen-supply voltage is higher than the plate-supply voltage. The oscillator depends for its functioning on secondary emission.

The potentials of the grid and screen largely determine the number of electrons which leave the cathode, but the

plate voltage determines the speed at which they travel, and of course the velocity with which they hit the plate. In any tube whose plate voltage is above a certain minimum value, electrons strike the plate with such force that they bounce off it. The electrons which bounce away from the plate are in a sense *emitted* by it, and the sum of the electrons emitted in this way constitutes secondary emission.

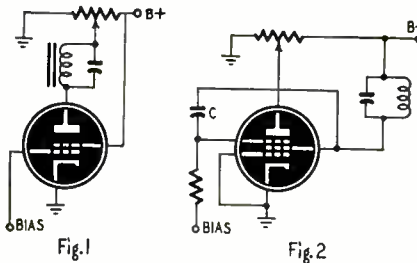

Fig. 1—The dynatron oscillator hookup.

Fig. 2—This is the transitron oscillator circuit. It has high stability.

In a triode, the plate is the only positive electrode, so the secondary emission electrons all eventually return to it. As a result, secondary emission has no effect on total plate current. In the circuit of Fig. 1, however, the screen has a higher positive voltage than the plate, so the secondary emission electrons, seeking the most positive point as a haven—as they always do—are drawn to the screen and pass through it back to the power supply.

The amount of secondary emission depends on how hard electrons from the cathode strike the plate (assuming screen voltage is constant), which in turn is determined by the plate voltage. And when the plate voltage is above a certain minimum value, each electron from the cathode actually dislodges from the plate several others, the number depending on the plate voltage. Thus—and this is the crux of the matter—as the plate voltage is *raised*, the plate loses more electrons by secondary

(Continued on facing page)

* Audio Consultant

ENGINEERED AMPLIFIER (Continued from page 29)

essary for proper adjustment. As these adjustments must be made with the amplifier on, the secondary of the output transformer must be connected either to a speaker or better to a 10-watt, 4- to 16-ohm resistor during the adjustment to insure that the transformer does not burn out.

Set the hum-balancing potentiometer R11 for least hum. On the radio input the hum level is more than 75 db below maximum signal.

In the utility model R7 has a different value than in the two-chassis model. Set it at 780 ohms or better, then adjust it to give an average 6B4-G plate current of 40 ma.

Listening tests

Various versions of this amplifier have been given long-range listening tests using several crystal, General Electric, and Pickering phonograph cartridges, disc recordings from many sources, and AM and FM radio programs. Speakers have included an 8-

inch electrodynamic in a conventional console cabinet, a 15-inch Jensen coaxial in both the same cabinet and in a bass reflex enclosure, a single 12-inch electrodynamic in a bass reflex enclosure, and a Klipsch speaker system. Listeners have included those with no musical background or appreciation, musicians, music lovers of all kinds, electrical and electronics engineers, and rabid hi-fi fans. The nearly unanimous conclusion is "The best I have ever heard."

Materials for Preamplifier

Resistors: 1—3,300, 1—5,000, 2—6,800, 3—10,000, 1—15,000, 5—22,000, 6—27,000, 8—33,000, 1—39,000, 1—47,000, 1—62,000, 6—68,000, 1—75,000, 1—100,000, 9—150,000, 2—220,000, 1—270,000-ohm, 1—1, 1—2.2, 2—3.3-megohm, 1/2-watt; 1—100,000-ohm, 1—2-megohm potentiometers.

Capacitors: 2—.0001- μ f mica; 1—.001, 6—.005, 1—.0075, 2—.01, 2—.02, 1—.04, 3—.05- μ f, 400 volt, paper; 1—10- μ f, 450-volt, 1—15- μ f, 150-volt, 1—20- μ f, 25-volt electrolytic.

Miscellaneous: 1—12SC7, 1—14AF7 tubes and sockets; 1—23-position rotary, 1—4-position, single pole, switches; 2—phono jacks; 1—4-prong power socket; chassis, hookup wire, assorted hardware.

Materials for Amplifier

Resistors: 1—4,700, 2—6,800, 1—10,000, 2—18,000, 3—82,000, 2—100,000, 2—270,000-ohms, 1—1, 2—4.7-

megohm, 1/2-watt; 2—250-ohm, 25-watt, 1—500-ohm, 25-watt, 1—7,500-ohm, 50-watt, with adjustable tap; 1—100,000-ohm potentiometer.

Capacitors: 2—.01, 1—.03, 2—.08- μ f, 400-volt, paper; 1—16- μ f, 500-volt, 5—20- μ f, 450-volt, 1—25- μ f, 25-volt, 2—50- μ f, 150-volt, 1—100- μ f, 150-volt, electrolytic.

Miscellaneous: 2—6SN7-GT, 2—6B4-G, 1—5U4-G tubes and sockets; 1—435-0-435-volt 200-ma power transformer with two 6.3-volt windings and one 5-volt winding; 2—10-h, 120-ma chokes; 1—audio output transformer (Acrosound model TO-250 or equivalent, 12.5 watts, 5,000 ohms primary impedance); 1—4-prong power plug; 1—3-amp fuse and fuse holder; 1—phono input jack; 1—s.p.s.t. line switch; chassis, hookup wire, assorted hardware.

Materials for One-Chassis Amplifier

Resistors: 1—3,300, 1—4,700, 1—5,000, 2—6,800, 4—10,000, 1—15,000, 1—27,000, 3—33,000, 2—68,000, 3—82,000, 4—100,000, 1—220,000, 4—270,000-ohm, 1—1-megohm, 1—2.2, 2—3.3, 2—4.7-megohm, 1/2-watt; 1—1, 1—2-megohm potentiometers; 1—1,000 ohm, 25-watt with adjustable tap.

Capacitors: 2—.0001- μ f mica; 1—.001, 5—.01, 1—.02, 1—.03, 1—.04, 2—.05, 2—.08- μ f, 400-volt paper; 1—8, 2—15, 1—50- μ f, 150-volt, 5—20- μ f, 450-volt, electrolytic.

Miscellaneous: 1—6J5, 2—6SN7-GT, 2—6B4-G, 1—6SC7, 1—5U4-G tubes and sockets; 1—power transformer, 435-0-435-volt, 200-ma, with two 6.3-volt and one 5-volt winding; 1—output transformer (Acrosound TO-250 or equivalent 12.5 watts, 5,000 ohms primary impedance); 1—10-h, 120-ma choke; 1—s.p.s.t. power switch; 1—s.p.d.t. switch, 1—s.p. 4-position, switches; 1—3-amp fuse and fuse holder; 2—phono jacks; chassis, hookup wire, assorted hardware.

emission than the cathode supplies to it. Plate current *decreases* (and may actually reverse). This is certainly in contravention of Ohm's law, which says that as voltage is raised, current, too, ought to rise. (Of course, screen voltage must always be higher than plate voltage so that the secondary electrons will go to screen and not return to the plate.) Since effective resistance can be defined as voltage divided by current and since plate current decreases when voltage rises instead of increasing as it ought to, the plate resistance of the tube is said to be negative.

Now let us see how this produces oscillation. Initially, plate and screen voltages are steady, as is tube current. Now a small random pulse of plate current passes through the tuned circuit to the supply. It causes a small instantaneous voltage drop across the tuned circuit, which makes the plate voltage a little less positive. Because of that, secondary plate emission drops and fewer secondary electrons are bounced from the plate and lost to the screen—velocity of the primary (cathode) electrons has momentarily decreased. According to the explanation above, plate current then increases. The increase in current passing through the impedance of the tuned circuit drops plate voltage even more and the action snowballs until plate voltage and secondary emission are at a minimum. This condition cannot remain in force, however, because of the tuned circuit, which has a high impedance only to a.c. As soon as conditions become steady, the impedance of the tuned circuit starts to decrease. There is no longer so much of a voltage drop across it and the plate starts to go positive again.

As it does so, secondary emission increases. This decreases plate current, making the plate even more positive, and again the action snowballs until the plate is at maximum positive potential, with minimum current. Because of the "flywheel" action of the tuned circuit, the a.c. plate voltage peak exceeds the quiescent positiveness and after the peak starts to recede in the negative direction, the entire cycle repeats itself.

This kind of oscillator has several excellent points. It is, first of all, a 2-terminal oscillator, meaning that only the two ends of the L-C circuit require connections. That eliminates the requirements for a coil secondary or for taps with consequent difficulty of adjustment. Second, it is a stable oscillator, especially when oscillation amplitude is kept low (easily done by adjusting the grid-bias voltage). Third, vibrato is easily applied to the oscillator by superimposing on the grid bias voltage a 5-8-cycle a.c. wave. This makes for a pleasant combination of amplitude tremolo and frequency vibrato (the latter because it varies the current through the tank coil).

The tank circuit must have reasonable Q because the circuit will not oscillate unless the impedance of the tank circuit (approximately L/RC) is equal to

or greater than the equivalent negative plate resistance. In practice this is not a difficult condition to meet.

Frequency and amplitude of the dynatron are not entirely stable over long periods, however, because they depend on secondary emission which varies among tubes of the same type and which within one tube changes with age. The transitron oscillator is an improvement on the dynatron which overcomes this disadvantage. Its circuit appears in Fig. 2.

Transitron oscillator

The transitron does not depend on secondary emission and is more stable than the dynatron. As shown in Fig. 2, the suppressor is biased negative and the plate voltage is kept low. In the quiescent state, a large number of the electrons from the cathode are repelled by the negative suppressor before they can reach the plate; they go to the screen. The first pulse of screen current passes through the tank, across which

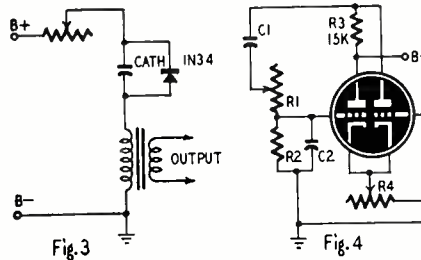

Fig. 3—A germanium crystal oscillator. Fig. 4—A Wien-bridge oscillator that is suitable for fixed-frequency uses.

there is a drop, making the screen voltage go in the negative direction. This small negative pulse passes through the capacitor C to the suppressor, making it more negative. This stops more electrons that would otherwise have gone to the plate, passing them to the screen instead. The additional screen current causes additional drop across the tank and makes the screen and suppressor still more negative. The action snowballs until the screen approaches maximum negativeness, when the negative buildup begins to slow down. When the peak is reached, nothing is transmitted through capacitor C to the suppressor, and it begins to return to its quiescent voltage, which is more positive than the present state. The increasing positiveness causes fewer electrons to go to the screen; the lower screen current has a lower drop across the tank, so the screen voltage becomes more positive. The positiveness is transmitted to the suppressor through capacitor C, and again the action snowballs until the suppressor is at maximum positive, plate current is maximum, screen current is minimum, and screen voltage is most positive. Then the cycle begins again.

As in the dynatron, oscillation amplitude may be controlled by applying some negative bias to the control grid (not shown in the figure), and vibrato can be added in the same way. Stability

of the transitron is excellent. Dr. Cleo Brunetti of the National Bureau of Standards reports that a well-designed transitron will show a frequency change of only .001% for a 33% change in B-supply voltage to the screen. Stability of that kind is well worth notice.

The waveshape generated by either of these oscillators is an excellent sine when oscillation amplitude is kept fairly low by adjusting the grid bias. At higher amplitudes it begins to distort, which is desirable for certain musical instrument designs, but frequency stability suffers.

Crystal oscillator

Ordinary germanium crystal diodes such as the 1N34 can be used as oscillators without vacuum tubes because of a negative resistance characteristic. Such an oscillator is described on page 47 of the October, 1949, issue of RADIO-ELECTRONICS. It is not especially suitable for music use, however, as oscillation depends on heat within the crystal. In addition, during this writer's experiments, three crystals (at a little less than a dollar each) were ruined in quick succession because the voltage needed in order to make it oscillate was greater than the crystal would take without damage.

Another 1N34 oscillator is shown in Fig. 3. This is a relaxation oscillator. Since an excess of inverse voltage across the crystal changes its characteristic from positive to negative resistance, at one point it has zero resistance. Voltage is applied to the capacitor from the supply. Because of the resistor there is an R-C time-constant circuit and the capacitor takes time to charge. When it charges to the point where the crystal exhibits zero resistance, the crystal shorts the capacitor and discharges it, whereupon the cycle starts over again. Because of the fact that the resistance of the crystal changes rather gradually as it approaches the zero point instead of breaking down suddenly as does a neon lamp or gas tube (thyatron) the output voltage is not a perfect sawtooth.

R-C oscillators

There are two principle types of R-C oscillators, Wien-bridge and phase-shift, though there is at least one other employing a parallel-T network in the feedback loop. Both are very stable when correctly adjusted.

The Wien-bridge oscillator is the most common type and is used extensively in audio test generators. It requires two tubes (or a dual tube), and consists simply of a 2-stage audio feedback amplifier of the usual resistance-coupled variety. Because two stages are used, the plate voltage of the second is in phase with the grid of the first. A Wien bridge connects these two points. The resistors and capacitors of the bridge are chosen so that a.c. of only one frequency passes through it without phase shift, while all others are shifted. The frequency whose phase is not shifted is the only one which will be fed back completely and is the fre-

quency at which oscillation takes place. Wien bridges are explained thoroughly on page 44 of the August, 1949, issue of this magazine, and on page 69 of the March, 1950, issue.

Fig. 4 illustrates a Wien-bridge oscillator circuit used extensively by the writer for fixed-frequency operation.

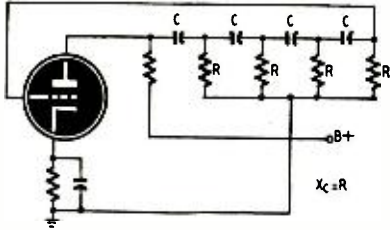

Fig. 5—A phase-shift oscillator that uses a 4-section phase-shift network.

The chassis in the photograph is a bank of seven neon oscillators and control tubes for a new organ to be described in a future issue. The eighth tube is a 6SN7-GT in the circuit of Fig. 4, used as a master oscillator to synchronize the six lower octaves.

The left section of the 6SN7-GT is a cathode follower. The right section is a grounded-grid amplifier whose cathode is coupled to the cathode follower. For stable sine-wave operation, the signal fed back to the first grid through the

Wien-bridge phase-shift network R1-R2-C1-C2 should be just equal to the original grid voltage, as in any feedback oscillator. Since the voltage loss through the phase-shift network is exactly 3 times, when $R1 = R2$ and $C1 = C2$, the net amplifier gain should be only 3. This is adjusted with R4, which can be a variable resistor for test purposes and may be replaced with a fixed resistor later.

The phase-shift components can be figured roughly by remembering that oscillation will take place at about the frequency at which the resistances and reactances are equal. One megohm and 150 μ f, for example, should cause oscillation at about 1,000 cycles.

The Wien-bridge oscillator is somewhat sensitive to changes in supply voltages, especially when the gain of the amplifier is a little more than optimum. Changes in supply voltages may change the gain, which will tend to change the frequency of oscillation to some extent. Changes of this kind and changes in characteristics caused by changing or varying the tuning components are usually taken care of in test generators with a small lamp in a cathode circuit. For single-frequency operation, however, that is not necessary. In the 6SN7-GT oscillator on the

chassis in the photograph a 20% change in supply voltage varies the frequency only about one-half tone. Under normal line-voltage variations, the change in pitch is insignificant. If used in a particularly bad district where line voltage is quite variable, voltage-regulator tubes may be used in the supply.

The second R-C oscillator is the phase-shift type. It is more stable than the Wien-bridge circuit and is more reliable at very low frequencies, for which reason it is often used for generating the 5-8-cycle vibrato signal. It is diagrammed in Figs. 5 and 6. In Fig. 5 a standard voltage amplifier has its output coupled to its input through a 4-section phase-shift network. At one frequency the reactance of each capacitor C will equal the resistance of each resistor R. (All R and C values are identical.) The phase shift in each section will then be 45 degrees and the total shift through four sections 180 degrees. The output at that frequency is then in phase with the input and the circuit oscillates.

Fig. 6 shows the vibrato oscillator used in the Lowrey Organ. This circuit is identical to that of Fig. 5 except the phase-shift network has only three sections. Each section must then shift phase by 60 degrees. The formula for calculating the components (derived by the writer from the more complex basic formulas) appears in the figure. In this case the oscillation frequency is about 8 cycles. The second section of the 6SL7 is simply an amplifier to amplify the vibrato signal before sending it to the circuits it modulates.

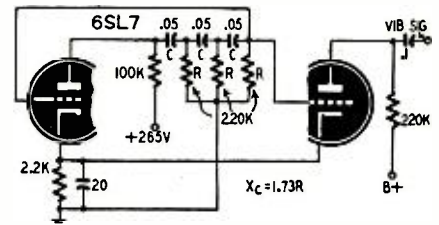

Fig. 6—Another phase-shift oscillator.

There is much more loss in the phase-shift networks of Figs. 5 and 6 than in that of the Wien-bridge oscillator. A medium- μ triode is therefore not suitable. For a 3-section network a high- μ triode such as the 6SL7 (one section), 6SC7 (one section), or 6SF5 is appropriate. Oscillators with 4-section networks may use the same tubes or a pentode such as the 6SJ7 may be found more reliable. In each case amplification should be adjusted (by choice of cathode resistor) for minimum gain consistent with reliable oscillation.

While all components of the phase-shift network should theoretically have the same value, fine tuning can be provided for when the oscillator is used as a musical tone generator by making one of the resistors R variable over a small range.

Next month we shall describe the *Thyratone*, a solo instrument designed and built by the writer, which readers may duplicate.

New Reproducing Curve for Disc Recordings

A reproducing standard for all types of disc recordings has been announced by the Audio Engineering Society. The need for such a standard has long been recognized by high-fidelity record fans and broadcast engineers who were forced to use complex equalizing networks which had to be changed almost as often as the records they played. The NAB (National Association of Broadcasters) developed a standard curve for recording in 1941 but many recording firms found it hard to follow in practice because of differences in studio acoustics, microphone techniques, orchestral balance, and other production problems. The net result of these difficulties is that at least five high-frequency preemphasis curves and four or more crossover points are in common use today. These may be combined to make up twenty different recording curves.

The reproducing curve shown in the

drawing is for use with standard 78-r.p.m. discs, transcriptions, and 33 $\frac{1}{3}$ - and 45-r.p.m. microgroove pressings. Its tolerance is ± 2 db. The crossover point is set at 400 cycles as a compromise between the 300- and 500-cycle crossover points which have been widely used in this country. The curve applies to points between the stylus and the output terminals on the amplifier. If the response of the loudspeaker system is linear, the curve will apply to the entire playback system. One of the advantages of this curve is that it can be produced by two simple R-C networks.

In a report in *Audio Record*, C. J. LeBel states that the recording engineer may use any characteristic he likes as long as it sounds good on the standard reproducing system. He predicts that most engineers will use a recording characteristic curve which is the inverse of the new reproducing standard.

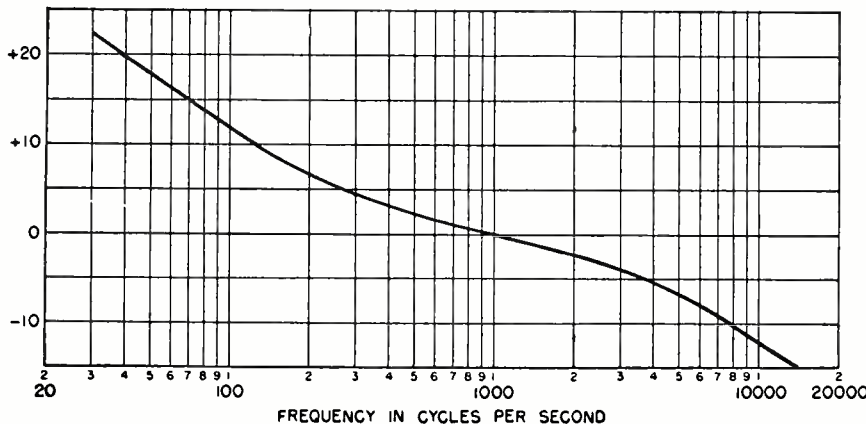

Audio Feedback Design

Part V—Some design refinements in amplifier circuits to improve frequency response and give stability

By GEORGE FLETCHER COOPER

THE first four articles of this series reviewed the general properties of negative feedback, discussed a method of design which is fairly easy to apply, analyzed an amplifier design, and (in the fourth article) described a new design. We shall now look into the solution of some problems which occur with more critical designs.

The design method described in the second article, which was to construct the amplitude and phase responses using simple templates, assumed that there were always sufficient margins to enable stability to be obtained. For example, if the amplifier was in danger of low-frequency instability, a coupling capacitance could be increased or decreased to get the extra stability. This was not stated explicitly, but as no alternative was given, the reader was confronted with this single solution.

This brute-force method is applicable only up to a point which is reached rather early. When you find that you need a 4- μ f coupling capacitor somewhere in the circuit it is time to get worried, because the stray capacitance to ground is going to produce some headaches at high frequencies. We must call up some design reserves. It is probably worth while using two small capacitors instead of one big one, because the small ones are much easier to mount.

The design refinements considered here include the use of extra capacitors to permit the use of smaller capacitors. For portable equipment the weight saving is often important, but this article stresses the increased amount of feedback which can be applied with the more thorough design.

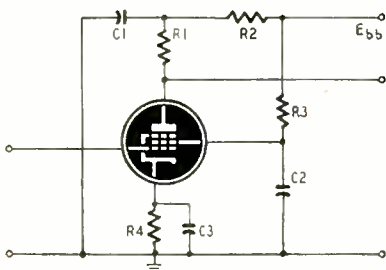

Fig. 1—Basic pentode amplifier hookup.

In the simple design a number of components were not made to earn their livings fully. These components were the decoupling capacitors and resistors. Using pentodes, there will be either two or three of each to each tube, and we can make them contribute to the stability as well as carry out their fundamental decoupling job. The basic circuit diagram which we need is shown in Fig. 1. At moderate frequencies, say 1,000 cycles, the gain of this simple amplifier stage is: $gR1$ where g is the transconductance of the tube.

Forget for the moment the screen and cathode circuits: the plate load is made up of $R1$ in series with the parallel combination of $R2$ and $C1$ (E_{bb} is grounded to a.c.), so that the gain at any frequency is:

$$g \left(R1 + \frac{R2}{1 + j\omega C1 \times R2} \right) =$$

$$g \frac{R1 + R2 + j\omega C1 \times R1 \times R2}{1 + j\omega C1 \times R2}$$

$$= g(R1 + R2) \frac{R1 \times R2}{1 + j\omega C1 \times R2}$$

I'm sorry about the mathematics, but if you, and the Editor, will take just a little more I'll try to keep away for the rest of the article.

In logarithms, to express the gain in decibels, we have:

The first term is the maximum gain, at zero frequency. The second and third

$$\text{gain} = 20 \log g(R1 + R2) + 20 \log \left(1 + j\omega C1 \frac{R1 \times R2}{R1 + R2} \right) - 20 \log (1 + j\omega C1 R2)$$

terms give the frequency response, and the point to notice is that they have the same expression $(1 + j\omega CR)$ as we had in the second article. We can therefore use our standard curves for working out the frequency response. All we need is the pair of characteristic frequencies:

$$\omega_1 = 1/C1 \times R2$$

$$\omega_2 = 1/C1 [R1 \times R2 / (R1 + R2)]$$

ω_2 is the frequency at which the response begins to rise: if $R2$ were big enough the response would rise by 3 db; ω_1 is the frequency at which it begins to flatten out again. Fig. 2 shows how we construct the response. We take

$$R1 = R2 = 100,000 \text{ ohms.}$$

$$C1 = 1 \mu\text{f,}$$

giving $\omega_1 = 10 (1/[100,000 \times 10^{-6}])$
 $\omega_2 = 20$

The curve marked ω_2 is drawn with the aid of the template described in the second article, the 3-db line being set at $\omega = 20$. The template is then moved across the paper to $\omega = 10$ and turned

over. It is not really necessary to draw the curve marked ω_1 , but the dotted curve can be obtained by sliding the template parallel to the $\omega = \text{constant}$ lines to add the two curves. The minus sign has been accounted for in turning the template over. The phase curves are shown in Fig. 3. Here I have not turned the template over in drawing the ω_1 curve, because it makes the diagram too big. It was turned over to get the difference curve shown by the dashed line. The reader will see that this 6-db rise in response gives a "phase bump" of 18°, midway on a log scale between the two characteristic frequencies. Adopting my principle of determining signs by common sense, it is clear that the phase shift produced by this circuit is such that it opposes the phase shift produced by a coupling capacitor, since the amplitude response rises instead of falls as we go down in frequency. This circuit therefore tends to make the phase margin bigger, although it does so at the cost of the gain margin.

At $\omega = 20$, however, we have gained 18° in exchange for 1.9 decibels. This seems a worthwhile trade, since we can always get more gain if necessary.

Cathode and screen circuits

Now let us turn to the cathode circuit. At very low frequencies $C3$ has no effect, so $R4$ produces some feedback: usually $R4$ produces about 6 db of

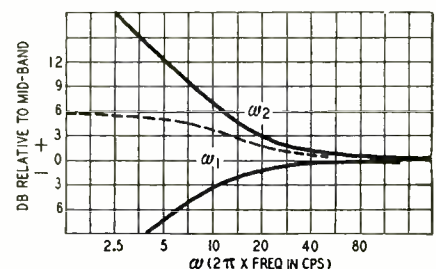

Fig. 2—The plate circuit frequency response of the amplifier of Fig. 1.

feedback in a pentode circuit. Approximately, the gain of the stage, considering only the effects of R1, R4 and C3, will be:

$$\frac{gR1}{1 + gR4/(1 + j\omega C3 \times R4)}$$

This is not the exact expression, as the g in the bottom line should include various screen conductance and trans-

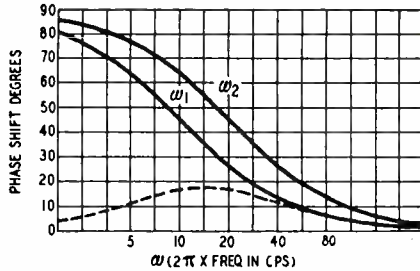

Fig. 3—The phase-shift curves corresponding to the curves shown in Fig. 2.

conductance terms, but the expression given is as accurate as the normal tube tolerances justify. At high frequencies, the gain reduces to simply gR1, and the response therefore is:

$$1 + \frac{j\omega C3 \times R4}{1 + gR4} (1 + gR4)$$

The two characteristic frequencies, by comparison with the equations we had for the plate circuit, are:

$$\omega_1 = 1/C3 \times R4$$

$$\omega_2 = (1 + gR4)/C3 \times R4$$

We can draw the responses in just the same way as before, noticing that the response starts to drop at ω_2 and

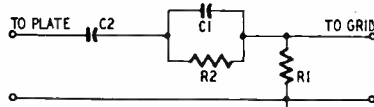

Fig. 4—A useful coupling circuit that makes more negative feedback possible.

then starts to flatten out at ω_1 . The resulting curves are reflections of the curves of Figs. 2 and 3 in the horizontal axis. I shall not draw them, because the reader can do this for himself. He will also, I hope, see that if ω_1 and ω_2 are chosen for the cathode circuit to equal the plate circuit values, the overall response will be flat.

Finally, the screen circuit. For this, if we have only R1, R3, and C2 to consider, the gain is

$$\frac{gR1}{1 + \sigma_s R3/(1 + j\omega C2 \times R3)}$$

where σ_s is the screen conductance. This effect is caused by feedback from the screen when it is not decoupled. Again the response drops at low frequencies according to the S-shaped characteristic, with

$$\frac{gR1}{1 + \sigma_s R3} \times \frac{1 + j\omega C2 \times R3}{1 + j\omega C2 \times R2/(1 + \sigma_s R2)}$$

The only disadvantage of this nice expression for the screen circuit is that you don't know the value of σ_s . The

tube maker never tells you that, not even in Europe. A rough value is quite easily found, however. When the working conditions for the tube have been settled, disconnect C2 and note how much the gain decreases at 1,000 cycles. Suppose that it is by a factor n. Then $n = 1 + \sigma_s R3$, and $\sigma_s = (n-1)/R3$. Then you can calculate the response.

Using the three sets of curves we have considered, we have the exact stage response, except for some interaction terms which may be neglected. We can choose the component values to help us to get a higher feedback factor. One word of warning, however: when the screen is affecting the response, the distortion starts to rise in a high-level stage. Hold that screen down, if you can.

Coupling networks

There is nothing more to be gained from the tube circuits: we must use

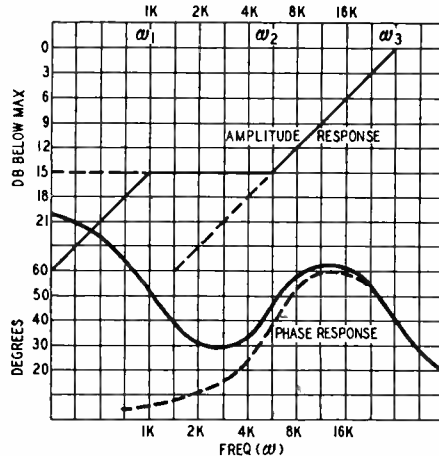

Fig. 5—Simplified phase and amplitude response of the network shown in Fig. 4.

more complicated coupling circuits if we want more feedback than the design seems to permit. Let us look at Fig. 4. Take no notice of C2, and assume that R2 is very large, about ten times R1. As the frequency is reduced, the response depends initially on C1 and R1, but when the impedance of C1 exceeds R2 the circuit degenerates into a simple resistance divider. I will not do any mathematics, but this circuit has three

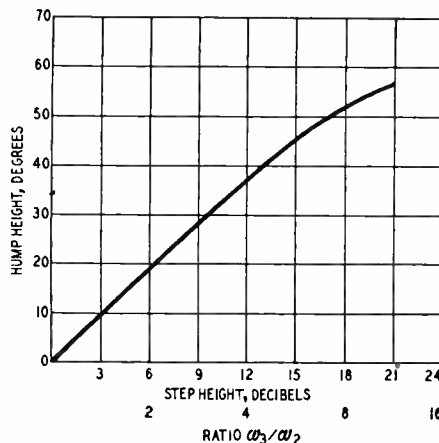

Fig. 6—The hump height in the phase characteristic of the Fig. 4 network.

characteristic frequencies which, if they are far enough apart, are:

$$\omega_1 = 1/C2(R1 + R2)$$

$$\omega_2 = 1/C1(R1 + R2)$$

$$\omega_3 = 1/C1 \times R1$$

At ω_3 the response starts to drop, at ω_2 it flattens out and at ω_1 it starts to drop again. The sort of curve we get is shown in Fig. 5, which was drawn using a linear cutoff template, not the exact one. It will be seen that the phase is about 60°, or less, down to a frequency at which the response has fallen by 17 db. With only the conventional coupling circuit the response has fallen only 3 db at the 60° point. This circuit therefore gives an extra 14 db of possible feedback.

When we neglect the ω_1 term, so that we have an elongated S characteristic, the phase is just the dotted hump. The size of this hump depends in the ratio of ω_3 to ω_2 , and the top of the hump is halfway, on a logarithmic scale, between ω_2 and ω_3 . In Fig. 6 I have plotted the hump height in terms of the step in decibels. This curve is for the smooth cutoff shown in the second article. It is, in fact, an exact answer instead of the approximate one obtained by the straight-line approximation. The curve of Fig. 6. is very useful in early design calculations. Suppose we have a 5-stage amplifier. We can allow 30° per stage and still have 30° margin. Then the step is just over 9 decibels, and we are free to apply $9 \times 5 = 45$ db of feedback. From this beginning we go on to calculate in more detail. A practical point is that C1 has no steady voltage applied, so that it can be a low-working voltage type.

At high frequencies, as we saw in the earlier articles, the tube capacitances and strays begin to cause trouble. Fig. 7 shows the bare bones of a circuit which does for high frequencies what the circuit of Fig. 4 did for low frequencies. Here R1 is the normal plate load, C2 the normal plate capacitance, including strays and the input capacitance of the next grid. C1-R2 are the additional components. For this circuit, as the reader can check for himself, the characteristic frequencies are:

$$\omega_1 = 1/C1 \times R1$$

$$\omega_2 = \frac{1}{C1} \frac{R1 \times R2}{R1 + R2}$$

$$\omega_3 = \frac{1}{C2} \frac{R1 \times R2}{R1 + R2}$$

At ω_1 the response starts to drop, according to the "template" law. At ω_2 it starts to flatten out, having dropped $20 \log(1 + R1/R2)$ decibels.

At ω_3 it starts to drop again. The shape is just that of Fig. 5, twisted round, provided that $\omega_1 \ll \omega_2 \ll \omega_3$. Typical values would be R1 = 100,000 ohms, R2 = 11,000 ohms, C1 = 20 μmf, C2 = 100 μmf, giving

$$\omega_1 = 100,000 \text{ (16,000 c.p.s.)}$$

$$\omega_2 = 100,000 \text{ (160,000 c.p.s.)}$$

$$\omega_3 = 5,000,000 \text{ (800,000 c.p.s.)}$$

The step height is then 20 decibels, and the phase hump rises to 55°. The curve of Fig. 6 applies to this circuit, too, except that the ratio scale is now ω_2/ω_1 . This stabilizing circuit is the salvation of a good many amplifiers.

The feedback network

Finally, there is a network which we can put in the feedback path itself. Why are we troubled by instability? Because the $K\beta$ falls too quickly, almost invariably at the top end. The

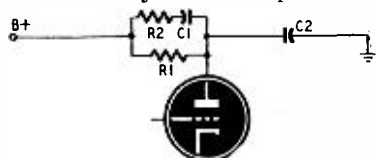

Fig. 7—A modified plate circuit that helps out the high-frequency response.

low end we can handle by ordinary component changes, if necessary using circuits of the type shown in Fig. 4. At the top, if we cannot prevent K falling rapidly, let us make β rise. Fig. 8 shows a way of doing this. At frequencies in the working band the feedback resistor is made up of $(R1 + R2)$. At high frequencies it is just $R1$. This makes the factor $K\beta$ more nearly constant. The characteristic frequencies of this network are:

$$\omega_1 = 1/C \times R1$$

$$\omega_2 = \frac{1}{C \frac{R1 \times R2}{R1 + R2}}$$

and all our template tricks, and the curve in Fig. 6, can be used again. I will not go into this in detail, because any reader who has gotten this far in designing an amplifier should be able

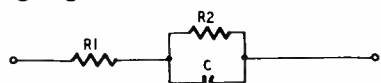

Fig. 8—Use this circuit in the feedback for stability at high frequencies.

to satisfy himself about the application of this network. I use this circuit for final equalization of the response characteristic at high frequencies, as well as for stabilization.

Of course it is simpler to omit these circuits from an amplifier and allow plenty of phase and amplitude margin in the interstage coupling circuits, but then you have just an ordinary amplifier. These refinements make the difference between a really good job and the common garden variety.

All the circuit methods described in this article are easy to use once you get a grasp of them. I find now that I can sketch Fig. 5 on the back of an envelope with enough accuracy to give a quick answer in the lab. But I must have drawn this more than fifty times in the office, too. The first time is sweat and tears, but the fifty-first, a ten-year old could do. The real problems arise with positive feedback, which I hope to discuss soon. In the meantime I plan to describe a method of testing amplifiers which is better than using the Nyquist criterion.

Rhombic Antenna for TV

Being a wideband antenna with gain directly proportional to its size, a rhombic is particularly useful in fringe areas where set owners are more likely to have enough space for one. A top view of the rhombic is shown at *a*, the side view at *b*, and a matching arrangement at *c*. The table gives dimensions of rhombics which will fit available space.

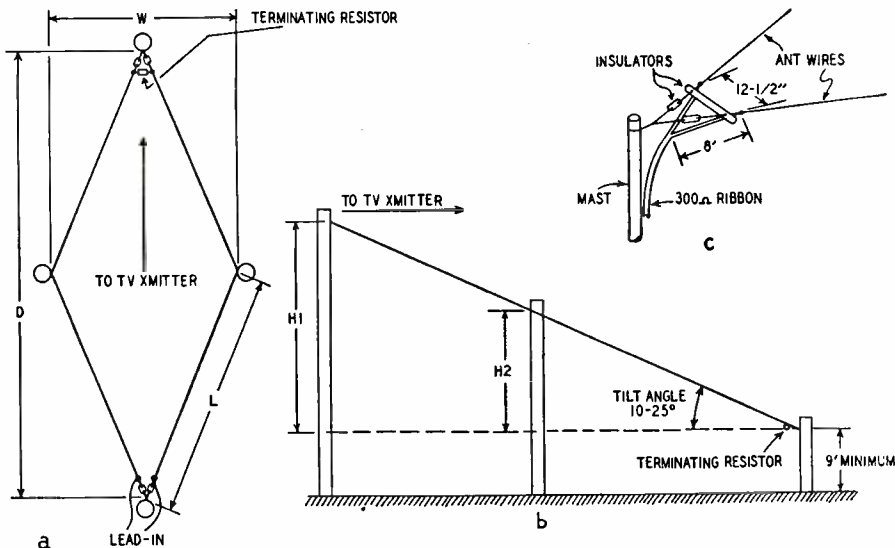

Generally the rhombic antenna is most suited for flat or gently rolling country. It can be used successfully in hilly terrain, but this requires some adjustment of the height and of the included angles of the antenna. Since this is usually inconvenient, other types of antenna are recommended.

Greater signal strength and less noise pickup are obtained by tilting the antenna with the lower end toward the transmitter as shown at *b*. The tilt angle becomes smaller as the antenna size is increased. It should be between 10 and 25 degrees for the sizes shown. Experiment to obtain optimum performance on any one channel.

If metal poles are used, space the side poles so they are at least several feet from the side corners of the antenna. This precaution is not necessary at the fore and aft ends. Do not use strain type insulators at the fore and aft as they introduce too much shunt capacitance.

The lower end of the antenna should not be less than 9 feet above ground and preferably should be 18 or 20 feet high. $H1$ is the difference in height of the two ends of the antenna and $H2$ ($1/2$ of $H1$) is the height of the center poles above the lower end.

To make the antenna directional, the lower end should be terminated with approximately 800 ohms. A convenient

terminating resistance is made from two 390-ohm, 1-watt carbon resistors connected in series and sealed in a waterproof container. Short insulated leads are brought out for connecting to the antenna.

To match the antenna to a 300-ohm line, split 8 feet of the ribbon line at the end which connects to the antenna. Spread the ends to 12 1/2 inches at the point where they connect to the antenna. Pull the line taut and fasten it to the mast so the V slopes uniformly toward the joined section. This connection is shown at *c*.—*Hoffman Service Bulletin*

Space (in feet)		Antenna dimensions (in feet)				
Length	Width	L	D	W	H1	H2
25	10	14	25	10	11	5 1/2
50	25	28	50	21	18	9
75	35	41	75	31	20	10
100	45	55	100	42	18	9

TOOL FOR TV SERVICING

Particularly useful for TV servicing is this tool made from a thin fiber or plastic rod and a small piece of spring steel which may be cut from a spring out of an old lock or clock. Cut the rod approximately 6 inches long as shown in the drawing. Square the ends of the steel and force it tightly into one end of the rod so only 3/8 inch projects. This makes a handy screwdriver-type aligning tool. The blade is so small that it has little or no effect on tuned circuits. The insulated rod minimizes hand-capacitance effects.

Double the usefulness of the rod by cutting a slot 3/8 inch deep in the other end. When checking for intermittent or noisy joints and components, simply slip the slotted end over various leads

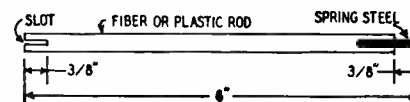

and twist gently. The slot will fit over leads only 3/8 inch long—a feat impossible with the bare fingers. There is no danger of short circuits, shock, or damaging components.—*David Gnessin*

Tester For 6-Volt Vibrators

A simple instrument that will test nearly any auto radio vibrator the service technician is apt to find

By **JAMES G. GREER**

THIS simple vibrator tester will test most of the vibrators encountered by the auto radio service technician. On P. 37 is a list of over 240 vibrators with the correct socket or adapter to use in testing.

The instrument was built mostly of salvaged parts. Some of them are not the best for the job but were used be-

cause they were available and would perform satisfactorily.

The photos and diagrams of connections of the tester with its three sockets (Fig. 1) and nine adapters (Fig. 2) should make construction easy. The constructor may desire to use a larger cabinet and wire up the sockets directly in the tester to eliminate the adapters.

Some of the sockets are special and are put out by Mallory as Kit No. SK1.

The input voltmeter should have a range of 0-8 or 0-10 volts d.c. and the output current meter a range of 0-50 or 0-100 milliamperes. In this tester a 0-10 ma meter was used with a shunt resistance to extend its range to 100 ma. The load resistance is 7,500 ohms rated at 50 watts. The capacitor across it should be 4 to 8 μf at 450 to 600 volts. A paper capacitor is recommended, although an electrolytic capacitor was used in this tester and is satisfactory. If an electrolytic capacitor is used, observe polarity and check its leakage to guard against misleading output current readings if the leakage should increase.

The 3-pole double-throw switch that transfers the secondary windings of the vibrator transformer from synchronous vibrator connection to rectifier tube for testing interrupter types of vibrators should have high-voltage insulation. As the author had no suitable 3-pole switch, two d.p.d.t. switches were used and a nail covered with spaghetti was pushed through holes in the toggles and a washer soldered to end of the nail opposite the head. This served to couple the two switches together. The double-pole double-throw polarity reversing switch is used to maintain proper polarity when testing synchronous vibrators and should be able to handle the high voltage.

All circuits carrying the heavy-current low voltage should be wired with at least No. 14 wire or larger. The proper value of vibrator or buffer capacitor depends on the particular vibrator transformer used. A 15-amp fuse is used in the automobile type fuse holder shown in the photo directly under the voltmeter and socket No. 1.

Either a storage battery or an A-eliminator may be used as a source of power. If a storage battery is used, the 4-volt input required for the starting test is obtained by connecting the battery clips to only two cells of the battery.

Good vibrators will start at 4 volts input and give steady output about $\frac{1}{2}$ to $\frac{1}{2}$ less than the output current at 6.3 volts input. At 6 or 6.3 volts input good vibrators will give steady output. If a variable A-eliminator supply is used or an extra storage battery cell is available an overload test may be made at 8 volts.

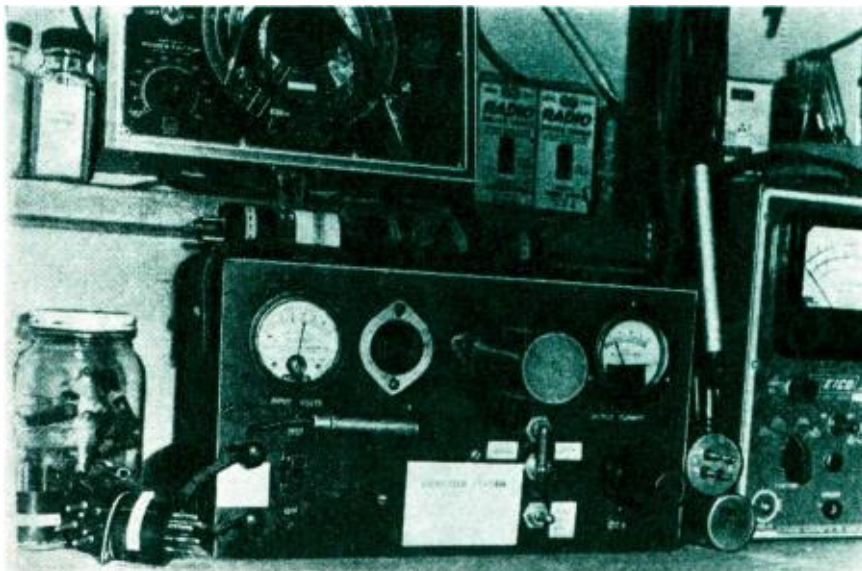

The vibrator tester in use on a service bench. Over 240 different brands of auto radio vibrator can be tested by using the appropriate socket adapter.

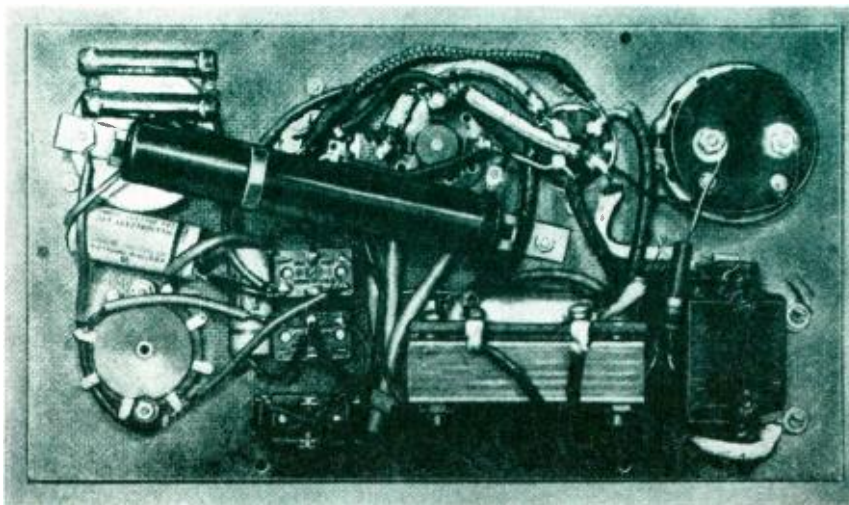

Behind the panel view of the tester showing the layout of the components.

In this particular tester, good synchronous vibrators show output current of 18 to 25 ma at 4.2 volts input and 28 to 45 ma output at 6 volts input. Interrupter types will give less output due to drop in the 0Z4 rectifier. In the photo showing tester in operation, a Mallory type 247 vibrator is shown in adapter 6, and as is evident from meter indications is passing the starting test satisfactorily.

Some new vibrators will not start because of oxide on contacts. Start these by connecting the vibrator running connections in series with a 50-watt lamp and 115-volt, 60-cycle source. Run it for a minute or two and check every half minute for proper operation in tester. This procedure will usually get the vibrator started.

Some original equipment vibrators may have different base connections than the replacements, so it is advisable to check with the vibrator data put out by the manufacturers. In making up the adapters, use only the large size tube bases, as the sockets will not fit properly into the smaller tube bases.

The list that follows shows which brands of vibrator can be used with the nine adapters and three sockets of the tester. The list includes practically every type found in auto radios.

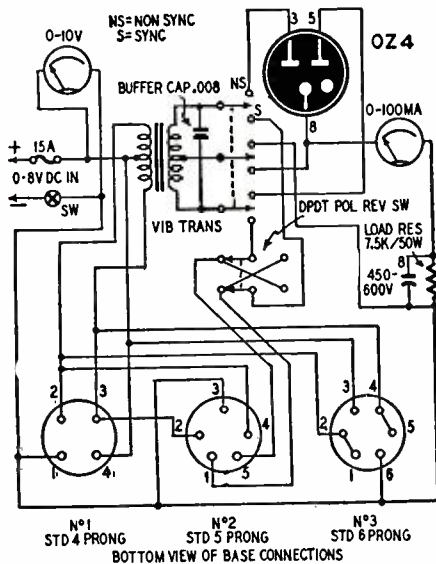

Fig. 1—Circuit for testing all types of 6-volt vibrators. The size of the buffer capacitor depends on the type of vibrator transformer that is used.

Adapter No. 1.

- MALLORY: 852, 860, 870.
- RADIART: 5303, 5333, 5335.
- PHILCO: 38-9913.
- ELECTRONIC: EU3, 2689.
- DELCO: 8528, 8531, 1213671-732, 7237244, 7237245, 7237246, 7237247, 7237499, 7237500, 7237501, 7237600, 7237663, 7237664, 7237665, 7237666, 7238685, 7238829.
- ATR: 335, 338, 345.
- TURNER: T9, T9S.
- NATIONAL UNION: 402.
- UTAH: NP487, NP45, NP480.
- MEISSNER: 435, 436.

Socket No. 1.

- DELCO: part 5040000.
- MALLORY: 1501.
- MOTOROLA: part #3333.
- RADIART: 5342M.

Socket No. 2.

- DELCO: 8610, 8611, 8112.
- ELECTRONIC: EU4, 716.
- MALLORY: 245, 245A, 270B, 271HD.
- MOTOROLA: 852, 942.
- RADIART: 5409, 5413, 5416, 5601.
- RCA: 11656, 80429-1.

Adapter No. 2.

- DELCO: 8504, 8505, 8506, 8508, 8510, 8523, 8524, 8525, 8526, 8527, 8529, 8530, 8532, 8533, 8534, 8539, 8540, 8541, 8543, 1209810, 1209811, 1209813, 1212966, 1213655, 1213881, 1215198, 1215909, 5040000, 5042240, 5043025, 5052378, 5052538, 5057220, 5061036, 7239123, 7239124, 7239439.

- ELECTRONIC: 1703, 2041.
- NATIONAL UNION: 404, 406, 408, 400.
- OAK: V5105, V5133, V5179, V5193, V5337, V5359, V5410, V5527, V5530, V5570, V5641, V5745, V6248.
- MALLORY: 294, 505P, 826C, 825C, 839, 859, 901M, 1100, 854, 507P, 853.
- RADIART: 3260, 3262, 3264, 3782, 3741, 3806, 3815, 3842, 5300, 5301, 53088, 5314, 5320, 5320P, 5325P, 5326P, 5327P, 5330, 5331, 5340M, 5341M, 5342M, 5343M, 5501, 5503, 5515, 5516.
- UTAH: NP4, NP49, NP490, NP485, NP484, NP42, NP47, NP48.

Note: Many vibrators listed under adapter No. 2, can be tested direct in socket No. 1.

Socket No. 3.

- MALLORY: 298, 506P, 1502.
- JAMES: PJ4.
- RADIART: 5324P, 5365.
- TURNER: T4S.

Adapter No. 3

- ATR: 508, 521, 530.
- CORNELL-DUBILIER: D10, D25.
- DELCO: 8612, 8621, 605666, 1209280, 1209282, 5037400, 5038055, 5039661, 5039757, 5040700, 5041245, 5053181.

- ELECTRONICS: 2682.
- JAMES: PJ60.
- MALLORY: 245C, 273C.
- MEISSNER: 704, 714.
- RADIART: 3461, 3679, 4613, 4614, 45190, 5425.
- TURNER: T54, T60.
- UTAH: SP51, SP55.

Adapter No. 4.

- MALLORY: 954.
- UTAH: SP633.

Adapter No. 5.

- ATR: 527, 562.
- CORNELL-DUBILIER: D11, D21, D35.
- DELCO: 8613, 8634, 5052525.
- JAMES: J58A, J58P.
- NATIONAL UNION: 600.
- MALLORY: 246, 246A, 743.
- MEISSNER: 712.
- OAK: D-7, 82ZH, V5064, V5118, V5124, V5208, V5269, V5369, V5413, V5645, V5670, V5868, V6270.
- RADIART: 4416, 4612, 5411, 5420P, 5421, 5435, 5439, 5610.
- TURNER: T58.
- UTAH: SP66, SP646.

Note: To test Zenith original part No. 190-6 use adapter No. 5 plus a wire clipped on pin 3 (A) of vibrator and connect to A-plus terminal post.

Adapter No. 6.

- ATR: 523.
- CORNELL-DUBILIER: D43.
- JAMES: PJ59.
- MALLORY: 247.
- RADIART: 5443, 3789.
- DELCO: 5053179, 8615.
- MEISSNER: 708.
- TURNER: T59.
- UTAH: SP6.

Adapter No. 7.

- ATR: 507, 547.
- CORNELL-DUBILIER: D29.
- DELCO: 8622, 8629, 8630, 5041376, 5050050, 5050498, 5054500, 7233419, 7235951, 7236066, 7238525.

- ELECTRONIC: 2092.
- JAMES: PJ62, PJ66.
- MEISSNER: 726.
- MALLORY: 514, 716, 273D.
- NATIONAL UNION: 500.
- RADIART: 4504, 5426, 5429.
- TURNER: T62, T66.
- UTAH: SP25, SP54.

Adapter No. 8.

- ATR: 525, 537, 548, 561.
- CORNELL-DUBILIER: D06, D54, DS05.
- DELCO: 8617, 8628, 8632, 1213446, 1214832, 5053183.
- ELECTRONICS: 2687.
- JAMES: PJ57, PJ63.
- MALLORY: 249, 725C, 742.
- MEISSNER: 719, 781.
- RADIART: 4255H, 4414, 5406, 5605.
- TURNER: T63.
- UTAH: SP71, SP72.

Adapter No. 9.

- ATR: 524, 564.
- ELECTRONICS: 2107.

- CORNELL-DUBILIER: D00, D07, D08, D38, D40, DS20.
- DELCO: 8616, 8635, 8636, 8643, 5052869, 5053501.
- JAMES: J52, J65SP, PJ65.
- MALLORY: 248, 748, 952W, 953W.
- MEISSNER: 723, 780.
- NATIONAL UNION: 602.
- RADIART: 5400, 5407, 5437, 5438.
- TURNER: T65.
- UTAH: SP62, SP640, SP641, SP645.

Materials for Vibrator Tester

Miscellaneous: 1—7,500-ohm, 50-watt resistor; 1—.008-uf, 600-volt paper, 1—8-uf, 600-volt, electrolytic capacitor; 1—vibrator transformer; 1—0Z4 tube and socket; 1—0-10-volt meter; 1—0-100-ma meter; 1—3-pole, d.t. 1—d.p.d.t., 1—s.p.s.t. switches; 1—15-amp fuse and fuse holder; 1—4-prong, 1—5-prong, 1—6-prong standard tube sockets; tube bases and sockets for adapters; chassis, hookup wire, assorted hardware.

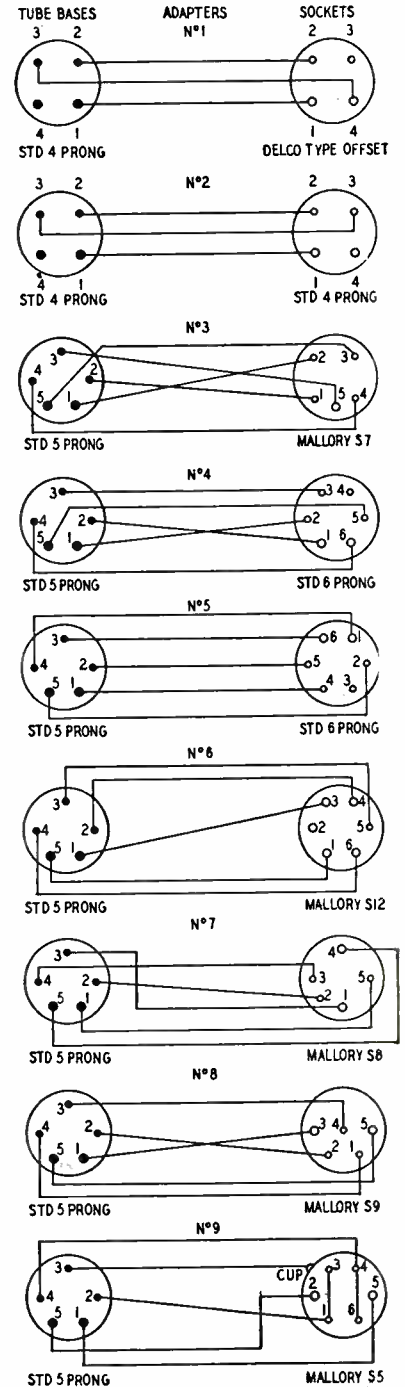

Fig. 2—Adapter circuits that will take care of all common vibrator types. The sockets are shown in bottom view, and the tube bases are shown in top view.

Fundamentals of Radio Servicing

Part XXIV—Receiver Refinements

By JOHN T. FRYE

IN THE preceding chapters we focused our imaginary microscope upon one stage after another of the radio receiver as we made a careful and detailed study of just what went on in each individual unit; now it is time to push our microscope aside and take a long look at the receiver as a whole.

Such a perspective-restoring look should do two things. First, it should reveal the articulation, or joining, of the various stages through circuit elements common to all. Second, it should permit us to see the various refinements of the basic receiver elements we have been studying—refinements that often embrace several stages in their operation and cannot rightly be said to belong to any one single portion of the receiver.

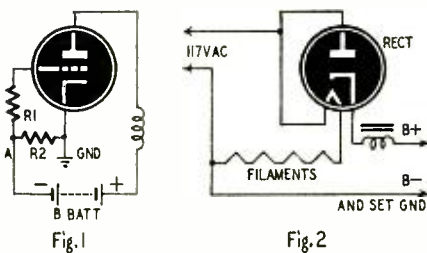

Fig. 1—Circuit in which the B-minus connection is not the same as ground. Fig. 2—In this circuit the B-minus is connected to one side of the a.c. line.

The first element that we notice as being common to the various tube circuits is the metal chassis upon which all of them are ordinarily mounted. (A few of the more elaborate receivers use one chassis for the power supply, output stage, and sometimes an audio stage, while the remainder of the set is mounted on a second chassis, the two being connected together by cabled leads.) In practically all receivers that use power transformers, this chassis acts as the ground for the set and a connection between this chassis and the earth is often recommended.

What is "ground"?

That brings us to a question: "What is a ground connection, and why do we have 'em?" Candidly, that is a question easier asked than answered.

Suppose we first point out what a ground *is not*. It is not necessarily the point of the circuit to which B-minus is connected, for B-minus is often con-

nected as shown in Fig. 1 so that we may use a portion of the B-voltage for negative grid bias on the output tube. In Fig. 1, the plate current flow through resistor R2 leaves point A negative with respect to the grounded cathode, and this negative voltage is transferred to the grid through R1.

Neither in this day of grounded-grid amplifiers, cathode-followers, etc., can we say that it is the part of the circuit to which any one tube element such as the cathode or filament is connected. We are not even safe in assuming that it is the chassis itself, because in a.c.-d.c. sets the set-ground is actually one side of the power line, as is shown in Fig. 2; and the underwriters will not permit the use of the chassis as a set-ground unless it is completely protected from any possibility of being touched by the user.

Since the chassis is usually anchored in the cabinet with exposed bolts, it is simpler to use a common ground lead for all the circuits of the receiver but to isolate this lead from the chassis itself. Both the chassis and this isolated lead are employed as grounds, for while B-minus is usually connected to the lead and most of the bypass capacitors are returned to it, the various shields of the receiver are grounded to the chassis proper. The two grounds are usually connected together by a $\frac{1}{4}$ -megohm resistor bypassed by a capacitor of around 0.1 to 0.25 μ f.

The a.c.-d.c. receiver also knocks into a cocked hat the definition of a ground

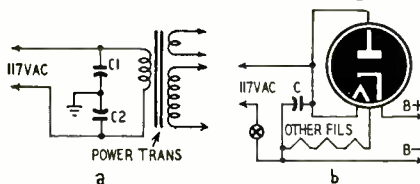

Fig. 3—Capacitance ground circuit for an a.c. and for an a.c.-d.c. receiver.

as being "a point of the circuit to which an earth ground may be connected without creating any disturbance." If you connect an earth ground to a hot-chassis a.c.-d.c. set, and if the line plug is inserted in the wall socket so that the ungrounded side of the light line is connected to the chassis, there will be considerable disturbance in the few milliseconds before the house fuses melt!

Perhaps it is best to say that a re-

ceiver ground is made up of all of those points of the circuit that are intended to be at zero signal potential at all times, and is the reference point from which all tube potentials—bias, screen, suppressor, plate, and cathode voltages—are measured. While it may or may not have an actual d.c. conducting connection to the earth, it ordinarily has a capacitance path the ground, as is shown in Fig. 3.

At "a" we have the a.c. input circuit of a transformer-type receiver. Capacitors C1 and C2 connect from each side of the power line to the receiver chassis. Since one side of the line is always connected to the earth, that means that the chassis will always be grounded through one capacitor or the other, even though a wire is not run from the chassis to the earth. In the same way, at "b" of Fig. 3, a capacitor directly across the line insures a similar connection to the earth, no matter which side of the line may happen to be connected to the set-ground of an a.c.-d.c. receiver.

All the tube circuits share a single ground connection to provide a common footing that permits easy transfer of energy from one stage to another. Without such a common connection, the receiver would be like a bucket-brigade in which the members were all wearing roller skates; a man trying to pass a bucket of water in one direction while his feet are going in the other—a very low transfer efficiency!

Consider Fig. 4. We want to transfer the voltage developed across plate resistor R1 to grid resistor R2. Coupling capacitor C offers one path for this transfer, but we know that electricity refuses to leave home unless it has a round-trip ticket. A return path must be provided before energy can be transferred. The two grounds, which are both soldered to a common lead or the common metal chassis, provide just such a path, as indicated by the dashed line.

It might seem that since the chassis is serving as a connecting link between all of the stages and since all of the various signals are passing from one stage to another through it, there would be vast intermingling and confusion caused by this sharing of a common path. Two things prevent this: first, the ground of a receiver always has an extremely low resistance; and currents passing through it encounter practically no impedance to dam their passage, and

so permit them to build up individual potentials. Second, this ground always has some connection with the earth, and the earth has an infinite ability to absorb an excess of electrons or to supply a deficiency of them. Since a voltage is always produced by too many or too few electrons, this neutralizing earth-ground will prevent any such voltage from developing.

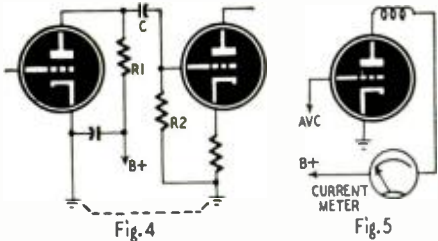

Fig. 4—The broken line indicates how the chassis makes a complete circuit. Fig. 5—A simple form of tuning meter.

It is as though we had several high-pressure streams of water shooting into the Atlantic Ocean on this side and an equal number of high-pressure pumps drawing water out of the English Channel. While we could say that water was being transferred across the sea, no currents could be traced from one pump to another across the vast expanse of water. In the same way that the streams of water are all reduced to zero-pressure value in the ocean, so are all signals reduced to a common zero-potential figure for their passage through the ground leads of a receiver.

Tuning indicators

A good service technician listening to a receiver that is slightly off-tune is affected in the same teeth-on-edge way that many people feel when they hear a piece of chalk squeaking on a blackboard. The better the selectivity of the receiver, the greater is the impairment of tone caused by improper tuning. To avoid this trouble many receivers are equipped with devices to indicate visually when the set is tuned exactly to a station.

A simple form of such indicator, diagrammed in Fig. 5, consists simply of a current-indicating meter in the plate circuit of a tube whose bias is controlled by the a.v.c. system. As we know from our study of the last chapter, when the receiver is tuned to a station, the a.v.c. voltage goes up and the plate current of the tubes controlled by this voltage goes down. The full a.v.c. voltage is developed when the receiver is tuned to the exact center of the transmitted carrier; so when our plate-current meter indicates minimum current we know that the receiver is tuned exactly to the station. There are many variations of this basic idea: the meter may read the plate current of two or more controlled stages; it may be placed in the cathode circuit; it may be used in conjunction with a bridge circuit so that it will read forward instead of backward to indicate maximum carrier strength, etc.; but the principle remains the same.

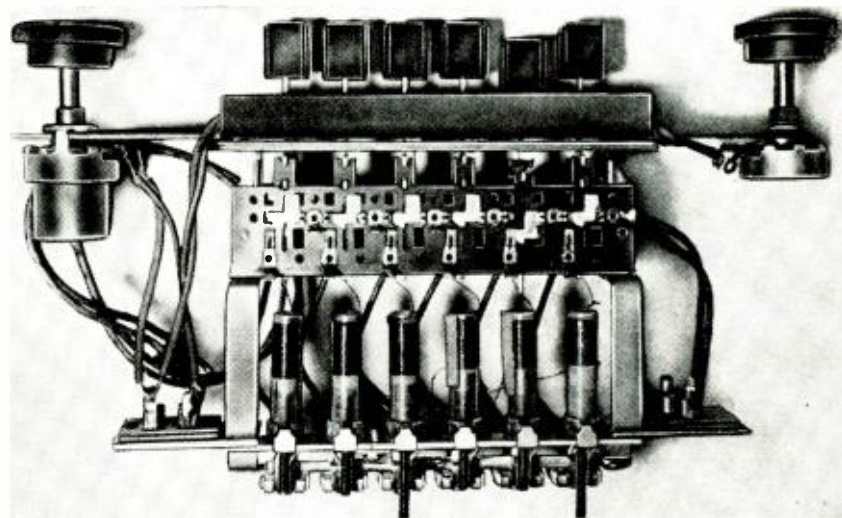

Photo A—A push-button tuning assembly such as the one diagrammed in Fig. 10. The treble and bass tone controls are mounted on the push-button assembly.

The electron-ray tube, such as the 6U5, is an electronic tuning indicator that has always struck the writer as being one of the most beautifully simple and workable inventions ever produced by the radio engineers. It consists of, first, a triode tube and, second, within the same envelope, a funnel-shaped "target," the inside of which is coated with fluorescent material that glows a bright green whenever and wherever electrons from the cathode strike it. Fig. 6 is a simplified drawing of this construction.

Fig. 7 shows the circuit of the electron-ray indicator. The target has about 250 volts applied to it and attracts many electrons from the cathode. The plate of the triode is fed from the target voltage through a 1-megohm resistor, so the actual plate voltage varies

with the plate current. This plate current is controlled by the a.v.c. voltage, to which the grid of the triode is connected.

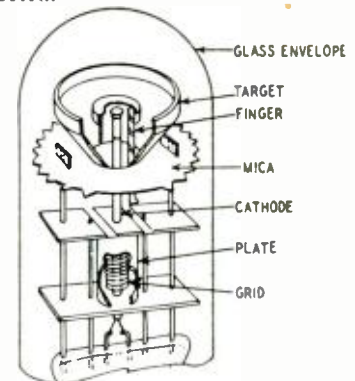

Fig. 6—An electron-ray tube structure.

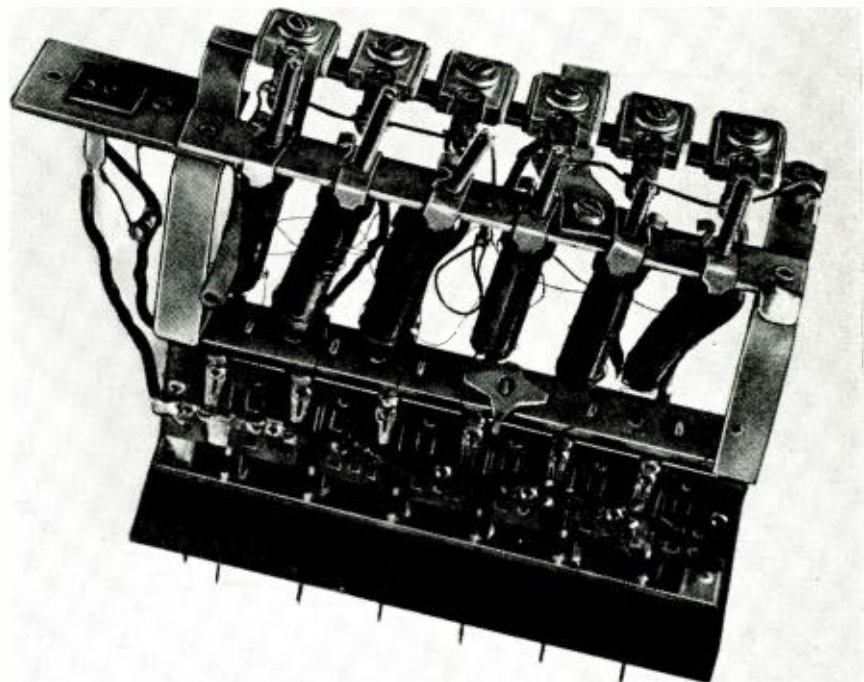

Photo B—This is what can happen when the set owner tries to do his own repairs. This tuning assembly was not run over by a tank, but was brought to a service shop for repairs after its owner had tried to align it himself.

As shown in Fig. 6, a little "finger" is attached to the triode plate, and is located between the cathode and the target. When the voltage on the plate—and consequently on the finger—is less than the target voltage, the comparatively negative voltage develops an electrostatic field about the finger that shields a portion of the target from the electron stream and so produces a

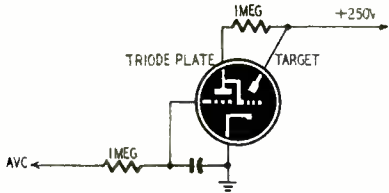

Fig. 7—Circuit of the indicator tube.

wedge-shaped shadow on the glowing circular target face. When the a.v.c. voltage increases as a station is tuned in, the plate current of the tuning-eye triode decreases, and the triode plate voltage approaches nearer and nearer the target voltage. This means that the interfering field about the finger grows weaker, and the shadow becomes narrower. All the customer has to do is to tune for the narrowest shadow, and he will be sure that his receiver is correctly tuned.

Down through the years the radio engineers have been guilty of contributing to the laziness of the radio user. When the radio owner complained about having to tune three separate dials, the engineers gave him single-dial control; when the owner, with tin ear, was unable to tune his receiver properly by the sound of it, the engineers provided him with a tuning indicator that he could watch. But still he was not satisfied; he still had to turn that one knob and watch that tuning indicator. That was too much work, he said. The radio engineers reached for their slip-sticks and came up with automatic tuning. Then all the customer had to do was to push a button and the receiver was automatically tuned to the station he wanted.

There are about as many methods of automatic tuning as there are ways to cook an egg, but all of the methods may be labeled either mechanical or electrical.

The purely mechanical system is well

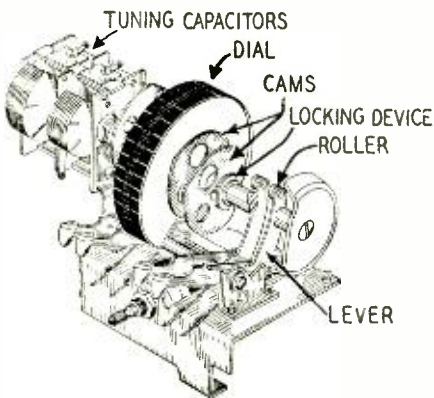

Fig. 8—One type of arrangement that is used for mechanical push-button tuning.

represented by the example diagrammed in Fig. 8. The shaft of the tuning capacitor has heart-shaped cams mounted on it and arranged so that they may turn on the shaft but can be locked in any desired position. Associated with each cam is a lever that forces a roller against the edge of the cam and pushes directly toward the shaft. Under this condition the cam and the tuning capacitor shaft rotate until the roller comes to rest in the V of the cam. By positioning the cam on the shaft so that this "at rest" position tunes in a desired station, that station can always be tuned in simply by shoving the lever that works the cam. As many stations can thus be set up for automatic tuning as there are cams.

A kind of "mule" system of mechanical tuning that is part mechanical and part electrical consists of a tuning capacitor that is turned by a small reversing electrical motor. In this sys-

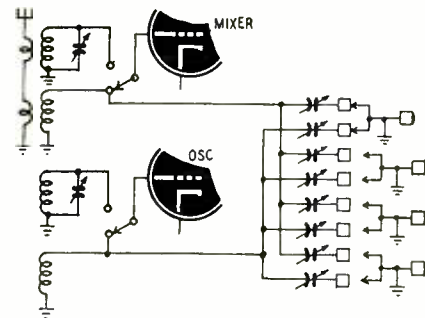

Fig. 9—A circuit for electrical push-button tuning. Each button connects a pair of capacitors to the tuning coils.

tem movable contacts on a broken slip ring are employed so that when one of these contacts is activated by a push-button switch, the motor turns the tuning capacitor in the proper direction to bring the break in the slip ring under the contact, at which point the motor stops. By placing a contact at the proper point so that when the motor stops turning a desired station is exactly in tune, automatic tuning is had. As many stations can be set up as you have contacts and associated push buttons.

All-electric push-button tuning, though, is the most popular. In one version of this system, the ordinary coil-and-variable-capacitor combinations that tune the oscillator and input circuits are switched out of the circuit and are replaced by coils that are tuned by pairs of semivariable capacitors, any one of which may be connected across the respective coils by push buttons, as is shown in Fig. 9. Note that each push button connects a different capacitor across the oscillator coil secondary and another across the antenna coil secondary. By preadjusting each pair of capacitors to tune in a particular station, the push buttons can be used to select those stations at will.

A variation of this method is diagrammed in Fig. 10 and is shown in Photo A. The difference lies in the fact that slug-tuned coils are switched across a fixed-tuned circuit in the oscillator

section to adjust the oscillator to different frequencies. At the same time, preset semivariable capacitors are switched across the input secondary as was the case in Fig. 9. The claimed advantage of this system is that the slug-tuned coils are a little more stable than the semivariable capacitors used to tune the critical oscillator frequency in Fig. 9. Since inductances in parallel have less inductance than either of the branches, it is easy to see why paralleling the fixed-tuned circuit of L and C that is resonant below the broadcast band, with adjustable inductances, will permit the oscillator to be set to any desired frequency necessary to tune a broadcast station. Photo B shows what can happen when a set owner tries to fix his own push-button tuning. (He must have used the Hammer method.)

We have barely scraped the surface of the subject of automatic tuning systems. For an exhaustive discussion of the subject, the writer recommends the *Technical Manual* published by P. R. Mallory and Company of Indianapolis.

Another gimmick

One of the circuits that the blossoming service technician is sure to run into is the tone control. Even many of the smaller midget sets have them, and there is hardly a set with more than five tubes that doesn't.

The simplest of tone controls is a capacitor in series with a variable resistor. The capacitor by itself lets the higher frequencies pass more easily, and the resistor controls the amount of the highs that are passed. If this combination is connected between the signal and ground, more low frequencies than highs will reach the speaker, and the low notes will seem stronger.

More elaborate tone controls use a stage that will amplify the low or the high frequencies, but not the sounds in the middle range. By making the gain of such stages variable at both ends of the audio spectrum, we get a neat way of controlling the sound that finally reaches the speaker.

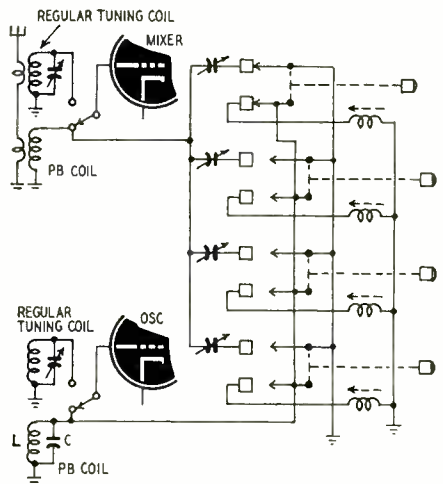

Fig. 10—Another type of push-button tuner circuit. This one switches slug-tuned coils across the oscillator coil.

demonstrate the radio, then tell him about the weak ones. He sees the radio playing and it looks like a chance to save some money. In most cases he will decide to wait a while about replacing the tubes.

Often an old set is brought in, sometimes a spare that is used in basement, barn or kitchen. When you have fixed what is immediately wrong, you notice that maybe the speaker rattles, there is a loud hum, or possibly an intermittent condition. The customer has probably noticed these things too, but in many cases he doesn't care. The radio is just to make companionable noises, and he doesn't mind pounding on it occasionally to make it play. So it is a good idea to get an O.K. before following your natural inclination to get it in good shape.



Some kinds of bugs in the circuit must be eliminated with a little insecticide.

Make a good estimate

Which brings us to estimates. Most people want to know how much it will cost before they have an old set overhauled. If you dig out everything that is wrong, you are in the hole ninety percent for the labor required to fix it if they don't want the repair job. If you refuse to make estimates you are bound to lose a lot of work and cause some ill-feeling. There is no easy solution; each case must be handled on its merits. If the set is obviously very old and beat up, most of the components are in a critical condition. It is best to turn down this kind of job.

If the set looks pretty good, make a rough estimate. Pull out the rectifier tube and make an ohmmeter check from cathode to plate for a short in the B-supply. If the speaker has a field coil, try for continuity from the rectifier cathode to output tube plate—this gives you a check on both field and primary of the output transformer. If the speaker field is in the B-minus circuit, check rectifier plate to ground—a Mallory Technical Manual will

show which way the field is connected. With a PM speaker, the ohmmeter test from rectifier cathode to output plate should give a sharp click, which gives you reasonable assurance that the output transformer and voice coil are all right. If the set has a power transformer, check rectifier plate to plate for proper high a.c. voltage, and leave the set turned on for about five minutes. A shorted power transformer will sizzle and smell within this length of time. Work the speaker cone in and out and see if it rubs. Test all the tubes, and check the continuity of the volume control and i.f. transformers.

This gives you a rough check on the major components in a dead set. It sounds like a big job, but you can do it on the average set in ten minutes and save yourself a lot of grief. You

should make a charge for your time if the customer does not want the set repaired. Make your estimate high enough to cover yourself—within reasonable limits—then stick to it, even if you have to go in the hole due to some unforeseen trouble.

Sales on the side

After you have been in business a while, you will probably expand into selling. Your satisfied customers are the best possible prospects, because you have the first chance at them when they bring in a set past fixing. Once you get a taste of the profits from selling, it is easy to overemphasize this part of your business, try for the easy buck, and let your service work slip. If you fall into this trap, you will sometimes advise a customer that it is cheaper to buy a new set, and he will go down the street and get his set fixed for three dollars. *Service work is the foundation of your business, because practically every store in town sells receivers.* Selling is a profitable sideline—and that is all it should be in a reputable service shop.

Many customers will ask you which is the best brand of radio. I suppose every repairman has a favorite brand, *but keep quiet about it.* You will certainly get very little guarantee work from the merchant whose line you knock, and most people are fishing for a compliment when they ask you if their set is a good one. It pays to be diplomatic even if they do have a clunker. After several years of working on them all, you will probably find that the best brand of receiver is largely a matter of taste. Some manufacturers emphasize appearance, some low cost, sensitivity, tone, or other features. Different segments of the public gravitate to what appeals to them (you have your own prejudices, too!) and the repairman's job is simply to fix them all to the best of his ability.

Remember your customers

One of the most ticklish problems of good customer relations is to remember names and faces, especially in a small town. Even though you only see the average customer every year or two, he expects you to remember him and what was wrong last time. Some fellows have a trick memory that makes this easy, but most of us have to work at it. It isn't too hard to remember the set, because you worked an hour or so on it, and you can refresh your memory on the details from your card file. But you only get a few fleeting glances at the customer's face, usually when your mind is on another job.

You will find some people easy to remember; a peculiarity of appearance, speech or manner makes a lasting impression on you. Others have an anonymity that makes them difficult to recognize after three or four meetings. Always take a good look at the customer and write down his name and address. If possible, associate his name with another object with which you are very familiar. For instance, if a man named Ford comes in, tie him in mentally with the famed flivver.

It helps to write down the name on the chassis or bottom of the set. If the name escapes you later, you can stall around until you get a look and see who it is. The knack of remembering people is very useful; if you get good enough, you can always run for office when things get tough in the repair business.

Friendliness, above all else, will be the key to your success. Give your customer a friendly smile and a cheerful hello when he comes in, even if it takes a little effort sometimes. People always like to do business in a shop where they feel their business is appreciated. What's more, your customers will actually have more confidence in you if you are pleasant with them. But don't just make with a chorus-girl smile. Be sincere. You will soon find that this makes your own work much more pleasant, too. If you follow these simple rules, you will have a better business and many satisfied customers.

Radio and TV Service Review

Some circuit features of Philco's 1951 line of television receivers

By DAN LERNER*

THE a.g.c. system of the 1800 and 2100 series consists of a variable type of delayed a.g.c. voltage. The variable-delay a.g.c. is obtained by applying a positive voltage to the cathode of the a.g.c. rectifier section of the 12AU7, as shown in Fig. 1. The a.g.c. plate is returned to ground. Since the cathode is positive with respect to the a.g.c. plate, there is no a.g.c. action unless the incoming signal is strong enough to overcome the delay voltage. The positive voltage is obtained by a voltage divider in which the contrast control is one leg. When a weak signal is being received, it is necessary to turn the contrast control clockwise, to maintain contrast. This increases the positive delay voltage applied to the a.g.c. rectifier, thus preventing a.g.c. action when receiving weak signals, where all possible r.f. and i.f. gain capable in the set is needed.

The delay voltage does not affect the video detector action, because the voltage is applied to the cathode, and the video detector plate (control grid acts as plate) is returned (through a choke and resistor) to the same d.c. potential. When a moderately strong signal is received, it is necessary to turn the contrast control counterclockwise, thus reducing the positive delay voltage. The a.g.c. voltage may be very readily checked with a 20,000-ohm-per-voltmeter connected to pin 3 of the ALIGN test jack. The a.g.c. action is relatively fast; the a.g.c. filter circuits do not contain a larger capacitor than 0.22 μ f.

The variable-delay system incorpo-

rates a sound a.g.c. boost. A portion of the voltage developed in the FM detector sound section is used to cancel out a portion of the positive delay voltage when a strong signal is being received. This results in full a.g.c. action on still stronger signals. This negative voltage from the FM detector not only cancels the delay but boosts the a.g.c. voltage as well. Thus the system provides flat a.g.c. action over a large range of received signal strengths.

Balanced beam

In the ordinary type of deflection yoke the deflection winding is wound in

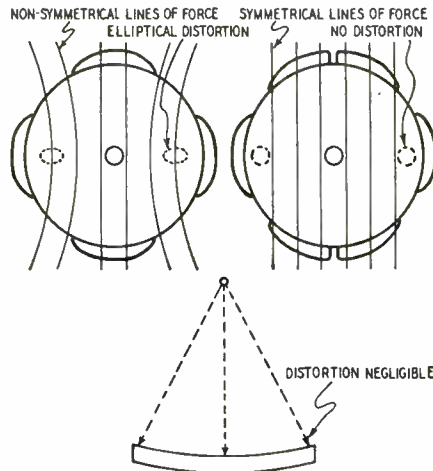

Fig. 2—The tapered deflection coil at right produces uniform field, thus reducing distortion at the edge of screen.

a symmetrical fashion around the neck of the tube. It was found that in normal sweep action the electron spot was distorted at either extreme of the deflection range. This distortion took the shape of a change in electron spot characteristics from a normal, rounded, well-focused area to a elliptical shape. This variation in electronic spot shape was due to the nonsymmetrical magnetic field produced by the deflection coil. It was found that while some distortion of the electron spot also occurred because of curvature of the cathode-ray tube face and because of the relatively longer path at the sides of the screen, this was negligible compared to that introduced by the nonsymmetrical magnetic-deflection field. This was corrected by winding the horizontal deflection coil in a tapered manner as viewed in cross section. See Fig. 2. With this new winding procedure a uniform field was produced. Thus, in the new 1800 and 2100 series good focus is obtained all over the screen surface.

Sync circuit

The new sync circuit (Fig. 3) as used in the 1800 and 2100 series incorporates a triode section connected as a diode and used as a noise gate tube or noise limiter. The partial sync separator half of a 12AU7 functions

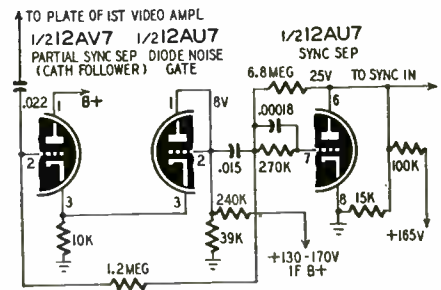

Fig. 3—The new cathode-follower sync circuit in Philco 1800 and 2100 sets.

as a cathode follower and does not give any amplification but affords good isolation and passes the composite video signal on to the sync separator half of a 12AU7. The signal is positive at this point. The plate of a noise gate tube is connected to the i.f. strip B-plus feed point so that any variations in i.f. B-plus value are reflected as changes on the plate of the noise gate tube. The 39,000-ohm resistor from the plate to ground drops the plate voltage to about 8. A negative grid bias of -5 to about -10 volts is fed back to the partial sync separator from the sync separator grid to aid its grid limiting action. The diode noise gate acts as a variable gating tube whose ability to conduct will vary directly with the received signal and the a.g.c. developed. If a strong signal is received, the a.g.c. voltage developed increases. This increases the negative bias on the i.f., which causes less plate current to be drawn and thus causes a higher B-plus voltage. This is reflected as a higher positive voltage at the noise gate plate which kicks the operating level of the diode to a higher value and thus allows a higher level of sync signal to be fed to the sync separator. When a weaker signal is received, the a.g.c. voltage developed is low and the B-plus voltage also is lower. Thus the plate of the diode noise gate is less positive and cuts off more easily than previously. Any noise in the region above the positive sync pulse will not appear on the sync separator grid, since the diode will cut off before the noise level is reached. This gives the picture better sync stability on weak signals and reduces the effect of noise on the sync.

*Television Field Service Engineer, Philco Corporation.

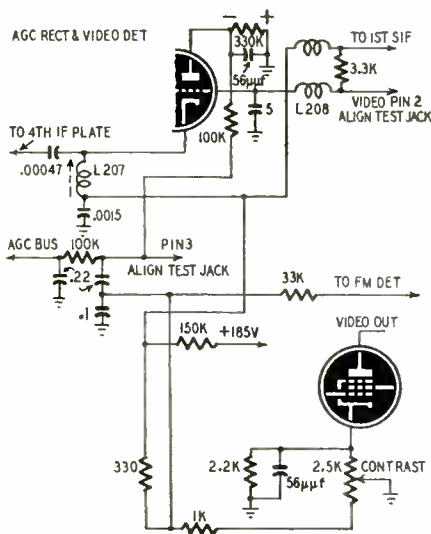

Fig. 1—The variable delay a.g.c. circuit of the Philco 1800 and 2100 series.

RELAYS

and their Operation

Part I

By JOHN E. PITTS, JR.

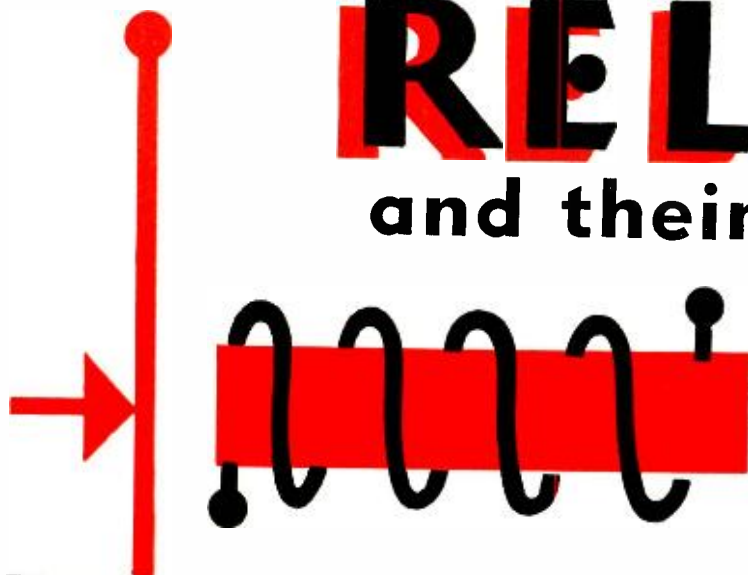

ELECTRIC relays are among the most fascinating subjects that a radio man will encounter in the pursuit of his hobby. They can be used all the way from simple local switching of a heavy current to selecting and operating complex functions from a control point located many miles away.

A relay in its simplest form is an

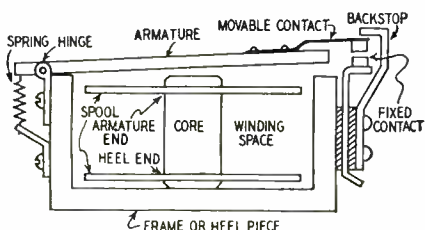

Fig. 1—A diagram of the simplest form of relay showing how it is constructed.

electromagnet, composed of a core of soft iron with a coil of insulated copper wire wound around it. At one end is an armature of soft iron mounted on a hinged support in such a way that the armature is attracted to the core when the electromagnet is energized. The free end of the armature carries a contact which alternately makes and breaks an electrical circuit with a second contact mounted on a rigid support. When the armature is attracted to the core of the electromagnet the two contacts touch. The force to pull the armature away from the pole piece when the current is interrupted may be obtained either from a spring or from gravity. Fig. 1 shows a relay in its simplest form, illustrating the fundamental parts.

A.c. relays

Relays are generally divided into two types, a.c. and d.c. While a.c. relays usually are more suitable from the amateur's standpoint, d.c. relays lend themselves more readily to various modifications and specialized uses, such as rotary stepping switches, slow-operate and slow-release relays, keying relays, etc. The essential difference between a.c. and d.c. relays, and one which is readily noticed when looking over relays, is that an a.c. relay generally has a laminated

core and always has a shading coil.

A shading coil is a single short-circuited turn of heavy copper wire or strap encircling approximately half the area of the face of the pole piece. This shading coil prevents the armature from releasing momentarily during the time the current is changing polarity in the a.c. cycle, which would cause severe hum and chatter of the relay contacts. It causes the magnetic lines of force of the shaded area of the pole face to be out of phase with those in the unshaded area, thus providing a constant magnetic pull on the armature during the cycle change of the impressed a.c. voltage. A shading coil is illustrated in Fig. 2, the relay armature being removed for clarity.

Relays carrying medium and heavy current usually have spring-loaded contacts so that they close before the armature and pole pieces meet, and are held against the fixed contacts by the spring pressure. Thus any slight movement of

the armature is not transmitted to the contacts to cause chattering and possible burning and sticking.

Solenoids

A variation of the fundamental type of relay is shown in commercial form in Fig. 3, the solenoid, a.c.-operated contactor. The core in this case consists of two piles of E-shaped laminations which have shading coils on their outside sections and the coil wound around the middle section. The two E sections then meet when current is applied, and operate to close contacts mechanically connected to one E section. This type of relay is used for heavy current applications, since the magnetic circuit is much more efficient than the previously described type, making greater magnetic force available for heavy contact operation. It is also used where a long arc-breaking patch is needed. Not all types of solenoids are efficient, however, and some are extremely inefficient. The longer the movement, the less the efficiency.

In general, the power required to operate an a.c. relay is greater than that needed to operate the same relay on d.c., though this is usually of little importance in most applications. In high-speed operation, an a.c. relay is not as satisfactory as its d.c. counterpart, since the a.c. cycle must be at the proper point to provide sufficient voltage to pull up the armature before the relay will operate.

Power calculations

The power required to operate a relay is generally stated in watts, but may also be expressed in ampere-turns ($N \times I$). However, watts is the simplest term to work with, and will be used here.

Let us take a specific example. A generator starting relay bought on the surplus market requires 24 volts, according to the nameplate, to operate it. With an ohmmeter we find the resistance of this relay is 240 ohms. By Ohm's Law we see that the operating current is 0.1 amp. From the formula $P = \frac{E^2}{R}$ or

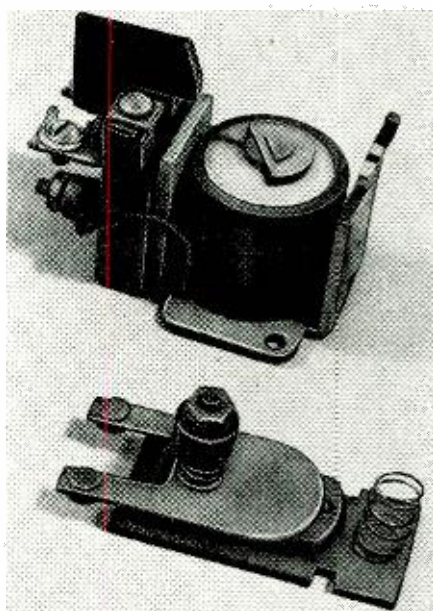

Fig. 2—An a.c. relay. The armature is removed to show the shading coil which is the D-shaped ring cutting the pole.

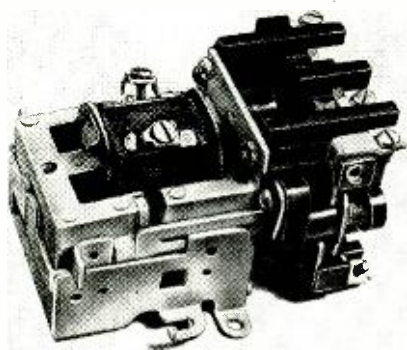

Fig. 3—An a.c.-operated solenoid. The shading coil is seen on the end of the left E section. This is a gravity release type and is mounted vertically.

$P = I^2R$, we find that the power required to operate the relay is 2.4 watts.

If we wish to operate this relay on a 6-volt storage battery in the car to start that mobile transmitter generator, we will have to rewind the relay with the proper size wire so that it will draw 2.4 watts at 6 volts. Using the formula $R = \frac{E^2}{P}$, we find that the relay must be

$$P$$

rewound to have a d.c. resistance of 15 ohms. A little careful juggling with a pencil and consultation of the wire tables will quickly show us the proper size wire to use to obtain a winding of 15 ohms, but keep in mind the current requirements to be met by the wire size so that it will not overheat.

Suppose we have a suitable relay, but no information to show what current or voltage is required to operate it. A safe rule to follow in this case is to measure the coil resistance, then connect the relay to a d.c. source and slowly increase the current until it just pulls up to close the contacts. Increase the current by 50 to 100%, depending upon the speed at which it is desired to operate the relay (a keying relay would naturally be high speed) and calculate the power consumed at that current. Then proceed as in the example above to rewind the relay for whatever voltage may be required. These simple calculations suffice for most relay problems that the radioman encounters.

D.c. relays

Direct current relays, because they are adaptable to low-current applications for remote control operation, are easy to adjust, dependable, and, particularly because they are available on the surplus market, should find favor in amateur applications for remote-control circuits. A complete description of all types of d.c. relays would be too lengthy for this article; however, those which lend themselves particularly to radio applications will be covered.

All ordinary d.c. medium-fast-operating control relays are of the same general type as we have described. While their physical form might vary, or one magnetic circuit path may be more efficient than some others, they are all generally alike.

Slow-release relays

The slow-release relay is used in circuits where a relay operates on the first of a series of impulses, but remains operated and does not follow the train of impulses, as during keying impulses in telegraph work or during dialing of a number to operate a selector switch, for example. This relay, illustrated in Fig. 4, has a very heavy band of copper, or shorted turn, around the heel end of the magnet core.

In certain cases it may be desirable to make the same relay either fast-operating, slow-releasing, or slow-operating. The coil is divided into two identical parts, one coil occupying the armature end of the core, and the other the heel end. Then by short-circuiting either the armature or heel-end coil, the relay is made slow-operating or slow-releasing. If one of the coils is not short-circuited, or is included in the circuit of the other coil series aiding, the relay will be fast-operating and fast-releasing.

The shorted turn, or slug, as it is called, causes a gradual decay in the electromagnetic lines of force in the core, instead of a rapid decay, as is the case with only the coil on the core. This is shown in Fig. 5. With a sufficiently large slug on the heel end of the core, and light contact springs, release-time delays of up to one second may be obtained, but this type of delay is not practical for longer periods, as the relay will tend to hang up and not release at all.

Slow-operate relays

By placing the slug on the armature end of the core, the relay is made slow-operating. The delay obtained between the time voltage is applied to the relay coil and the time the relay operates, because the building up of flux lines is retarded in that part of the core surrounded by the shorted turn. This is useful to delay the operation of certain functions for a certain period after the first application of voltage. Again, delays over a second or so are not practical, as erratic operation is sure to result. A slow-operate relay, is shown in Fig. 6, and the operation illustrated in Fig. 7.

Polar relays

Another relay which has many interesting applications is the polar relay, which, as its name implies, can be adjusted to respond only to currents of a particular polarity. A commercial polar relay is illustrated in Fig. 8.

The relay is so constructed that a movable strip of soft iron, called the armature, is mounted with its fixed end at the bottom of the U of a horseshoe magnet. Extensions to the north and south poles of the magnet, called pole pieces, are adjusted so that they are equidistant from the sides of the movable end of the armature. Fig. 9 is a diagram of such a relay.

Under correct adjustment the armature is attracted to neither pole without first being manually pushed toward one

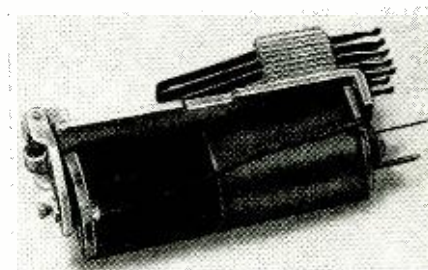

Fig. 4—A slow-release relay. The copper slug covers the coil's heel end.

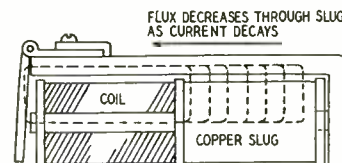

Fig. 5—A diagram of the slow-release relay. The copper slug on the heel end of the coil retards the decay of flux.

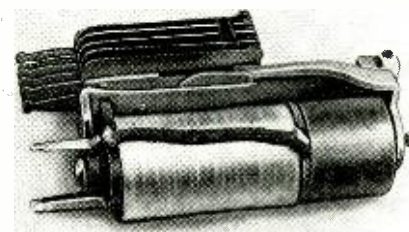

Fig. 6—A slow-operate relay. In this case the slug is at the armature end.

FLUX INCREASES THROUGH SLUG AS CURRENT RISES

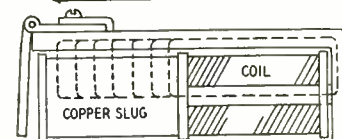

Fig. 7—A diagram of the slow-operate relay. The copper slug retards the increase of flux as the current rises.

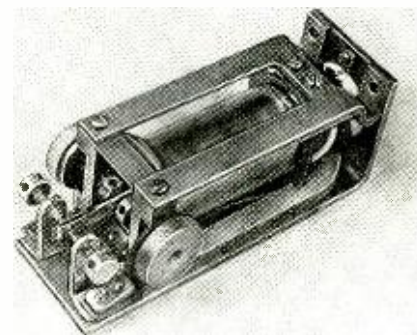

Fig. 8—Photo of a polar relay showing the contacts and pole-piece assembly.

side. The movable end of the armature is fitted with contacts so that an electrical connection may be made with stationary contacts C1 and C2 on the relay frame. These contacts are likewise adjusted so that in a de-energized condi-

tion of the relay coil, the armature contacts will touch neither fixed contact. The relay may be adjusted so that once operated to either C1 or C2 contact, it will remain there.

When a current is applied to the coil of the relay, if the polarity is such that the movable end of the armature assumes a north pole, the armature moves toward the south or P2 pole, if it is not already there. If it is, it remains there.

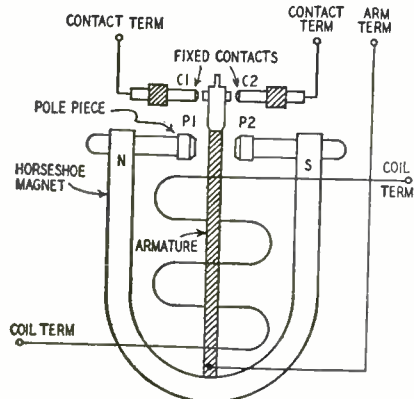

Fig. 9—A diagram of the polar relay.

If the direction of flow of current is reversed, the armature assumes a south pole at its movable end and moves toward the north or P1 pole. Thus the direction of flow of current determines the operation of the relay, and not necessarily the fact that a current is flowing. Uses of this relay will be covered under circuit applications.

Rotary selectors

Another type of relay is the rotary selector or "minor" switch, illustrated

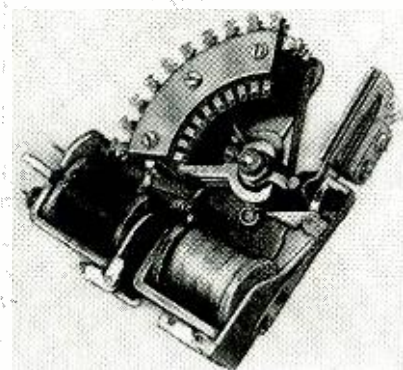

Fig. 10—A rotary selector switch that has three banks with ten points each.

in Fig. 10. This is a 10-position, generally 2- or 3-bank, rotary ratchet-operated switch. By means of this switch, control circuits may be devised which would be impractical without it.

A diagram is given in Fig. 11, showing the principle of operation. Pulsing the stepping magnet causes its armature pawl to engage the ratchet on the wiper shaft. This causes the wiper to step according to the number of impulses sent, either from a telephone dial or a switch of some similar type. The telephone dial will give more reliable operation for selection purposes, however, and is normally used. After the

train of impulses has been sent, the wiper arm comes to rest on the contact corresponding to the number dialed, and whatever circuit is connected to that particular contact is energized.

To restore the wiper to its normal position, so that other circuits may be operated, the release magnet is momentarily operated through the OFF-NORMAL contacts, disengaging the release armature pawl from the wiper ratchet, restoring the wiper arm by means of the spring attached to the wiper arm shaft. The switch is then ready for further operation. While the wiper is stepping across the various contacts, it is necessary to open the circuit to the wiper arm so that the circuits associated with the lower numbered contacts will not be operated as the wiper arm passes over them. For this purpose, one of the slow-release relays previously described is used. This will be further discussed.

Caring for relays

Relays suffer from too much care almost as often as from not enough. The useful life of the contacts ends when the contact material is worn away by excessive arcing, friction, or when it is too deeply pitted. Vaporization of the material because of too much arcing is usually the main offender.

Discoloration of the contact face should not be removed unless the relay is used in an atmosphere that has a high sulphur content. Dress dirty or pitted contacts with a burnishing tool or point file, or with crocus cloth. Do not remove any more contact material than is absolutely necessary and be sure to clean away all remaining particles of the abrasive.

Some arcing may always be visible at the contacts, but its destructive effect depends more on the duration of the arc than on its intensity. In many cases, if arcing is only slightly excessive, contact life can be increased by as much as three times if double-break contacts are used instead of single-break contacts.

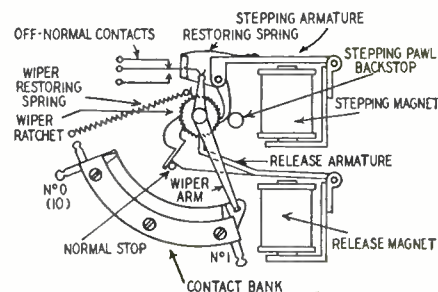

Fig. 11—Diagram of the rotary switch.

Reducing Cost of TV Servicing

The total cost of a repair job on a new TV, FM, or FM-AM receiver is likely to be higher than it should if you jump to hasty conclusions and replace filters, i.f. transformers, and other major components before determining the exact trouble in the set. When these sets are less than a year old, practically all troubles will be in tubes and capacitors. In nine out of every ten of these sets which have come in for repairs, the initial trouble has been traced to a short in a single ceramic capacitor. A bad tube or burned-out resistor may be expected as the natural result of the short. When tubes are gassy or show low emission, or the set is intermittent, check the ceramics. Ceramics rated at 500 volts often breakdown with as little as 75 volts on them.

Faulty ceramics can be hard to track down because many of them short or leak only when the heat is on. Heat will cause them to break down so they can be spotted, but don't use heaters or heat lamps on sets which contain plastics or plastic-covered wires or you may have a real repair job on your hands.

My favorite method of locating bad ceramics is to go over the set with a voltmeter and note the spot at which voltage is normal when first turned on and then drops rapidly as the set warms. When this point is located, remove one lead from each ceramic in that particular circuit, then tack them all back lightly with a soldering iron. Plug the set in and let it warm up while

you set your ohmmeter to the 20-megohm range. When the voltage drops as indicated on the voltmeter or by a drop in volume, rapidly pull the plug, unsolder a ceramic and check it with the ohmmeter. If the capacitor is the guilty one the needle will kick wildly and then fall back as the capacitor cools. Good capacitors will barely wiggle the needle, and the resistance will be 20 megohms or more.

Another type of trouble common to newer sets and seldom found in older ones is in i.f. transformers and traps having terminal lugs coming out through thermoplastic insulation. In some cases, too much heat has melted the plastic and allowed the lug to lean over and short to the can or chassis. In other cases, solder has been permitted to run down and short to the chassis. When this occurs at the plate side of an i.f. transformer or peaking coil, the short will usually burn out the winding. If the short happens at the B-plus contact, it may burn out a dropping resistor or even damage the power-supply components. When the short is on the secondary side of the transformer, the set won't work but there is little danger of serious damage.

Be fair to customers and to yourself. Check those ceramic capacitors and the condition of plastic insulation before replacing major components in a set. In many cases, it will enable you to give faster service at a lower cost.—Fairbanks Tryon

Planned Service Shop Layout Boosts Efficiency and Profit

Get out from under the junk heap and put some system into servicing

By T. W. DRESSER

IN A RECENT issue of RADIO-ELECTRONICS the editor pointed out the immense opportunities that now exist for service technicians, and stressed five items necessary for success in servicing: sound radio knowledge; intelligent work; honesty and fair play; good personal appearance; and keeping everlastingly at it!

No fault can be found with that summing up, except that there is more to it, as was brought home rather strongly to the writer by a visit to a dealer in a large English city. This particular dealer, one of the biggest in the place, has gone in for servicing on a really large scale over the past two or three years, and now handles an average of 50 or 60 receivers a week, from radio-phonographs to personals, at an approximate average of \$15 per receiver. (*These Englishmen get along pretty well—Ed.*)

In many ways he has been extremely thorough in the layout of his workroom and his equipment. His three employees each have a good signal generator to work with; there are two oscilloscopes in the shop, a first-class mutual conductance tube tester, a v.t.v.m. of reputable make, and, of course, each technician has a high-class multimeter at his elbow.

The room is light and airy and fitted with comfortable chairs and desk lights. Superficially a more efficient shop would be difficult to find, yet when I was there the technicians' tempers were frazzled raw! They were seeking a line socket, and the only vacant one was behind a mountain of junk which would take an hour to move!

The moral is of course, have plenty of line sockets. But it doesn't necessarily stop at that. A service room, like anything else concerning radio, should be *designed*. In the early days a technician bought a multimeter, screwdriver, pliers, and a soldering iron, and the servicing department grew round them. You can still find plenty such shops around, their benches littered

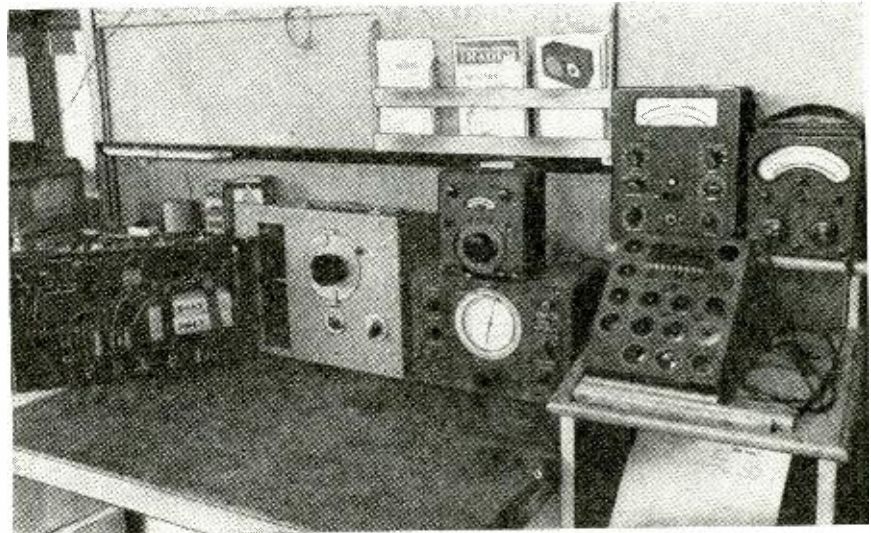

A small but efficient service bench. The most important test equipment is within easy reach of the operator, yet there is adequate space for working in front.

with defunct tubes and broken electrolytics. But they won't pay off today.

The newcomer to the game is at an advantage here. If he has found a shop and bought his equipment, he can visualize the room as he wants it and make his layout accordingly. The established technician is in a much more difficult position in that his gear has usually been bought piece by piece and fitted in wherever convenient in order to get it into use. Moreover he will generally have a full schedule of work on hand and stopping everything to lay

the shop out anew would knock a big hole in his income and put the schedule way behind. Consequently the situation gradually grows worse until the shop becomes a collection of junk.

In such circumstances it is strongly advisable to call a temporary halt, make out a list of the gear in use—and any new apparatus contemplated—and then make a rough sketch of the best layout for easy working. Finding the time to make the changeover will depend upon individual circumstances, and, of course, on the time of the year.

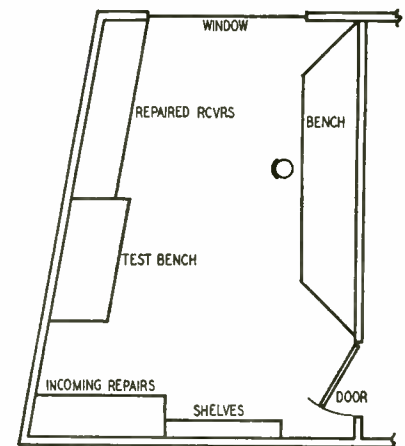
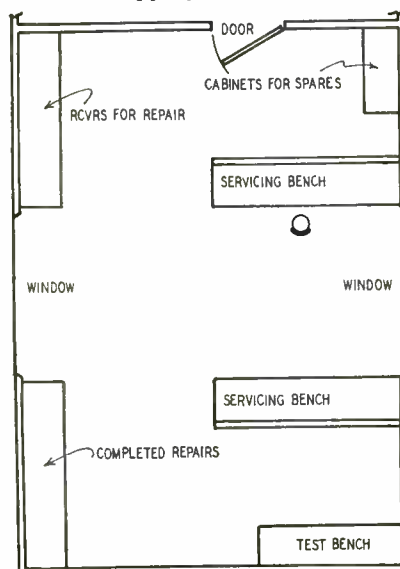

Fig. 2, above—Plan for a small shop.

Fig. 1, left—A layout for a service shop. Benches are located near window.



A well-lighted workbench that is free from junk makes for better servicing.

In the summer months when business is slack the overhaul could probably be done in one operation lasting two or three days. Alternatively, and particularly if there is much work on hand, a half day per week could be devoted to the task until it is completed.

No set rules can be laid down for the actual layout as so much will depend upon the gear in use, the dimensions of the room, window space, and the individual's own ideas. Figs. 1, 2, and 3 show suitable layouts for three different types of room. In each case provision has been made for as much natural light as possible on the repair bench, without the light falling directly in the technician's eyes. Strong sunlight in the face is not conducive to good trouble shooting nor to an easy temper.

A backboard type of bench construction is used in Fig. 1, leaving the whole of the bench free to work on. A.c. and d.c. sockets, both two and three pin, are mounted on the front of the bench,

grouped in order to prevent confusion. Antenna and ground sockets are placed at the rear of the bench, sufficient in number to allow three or four receivers to be tested simultaneously. Flush sockets are used in all cases because projections on the bench are always a source of trouble. They scratch and damage cabinets or they are broken by contact with tools or heavy chassis. In any case they are a menace. Using sockets for antenna and ground connections does away with tangling loose wires. Due to the wide variation of antenna and ground receiver leads, plugging in is not always possible. A few clip leads will make connection to any receiver easy.

The arrangement of the apparatus on the backboard, which incidentally should not exceed 2 feet 6 inches in height, also depends upon individual circumstances, but in all cases it is sound policy to mount most of the gear permanently on the backboard, excepting only the smaller instruments which are used outside the shop. Simple faults only should be tackled at the customer's home, and anything necessitating the

removal of the chassis from its cabinet should be handled in the workshop. This saves much time in the long run.

Mount the instruments so that they can be read and operated from a sitting position. Use a little careful thought when planning the instrument panel layout so that the most often used instruments will be in the most accessible position and so the test leads will have as little chance as possible to get snarled up.

In British service shops, the instruments are usually mounted so they protrude from the backboard, but Americans seem to prefer flush mounting. Both methods have their advantages, but the American perhaps gives a somewhat neater appearance. Which one to use will depend on how much space is available and on personal preference.

Be sure to include a heavy-duty line switch somewhere in the service shop so that all power can be shut off when the shop is closed. Don't spare the fuses, either. A shop should have a master fuse for the incoming power as well as fuses in the lines to each service bench.

It is important to know how many trouble-shooting positions are proposed, before actually laying out your own bench. Nothing is more annoying than to have the full output from a receiver on the next bench poured into your ear when you're working on a weak signal at your own bench. In such circumstances it is better to use separate cubicles lined with Celotex or other absorbent building board.

It is advisable to erect an anti-interference type antenna where the shop is situated within city limits or close to heavy road traffic. This must be left to the individual, as much depends on location. Manufacturers of antennas, both for broadcast and TV reception, will readily furnish advice on request.

The purpose of these notes is to help bring some system into servicing and to prove that a service shop need not be a tangle of wires and junk. "Sticky" jobs will still turn up, but a clear bench and good gear conveniently placed saves time and tempers on these and on ordinary jobs.

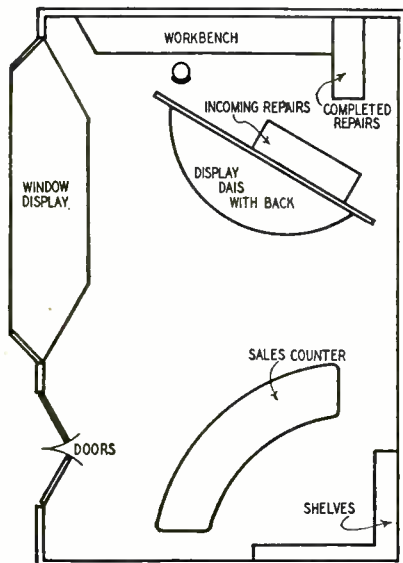

Fig. 3—A combined store and service shop. Display dais screens the bench.

U.S. SEEKS SHIPBOARD RADIO OPERATORS

Uncle Sam has positions open for radio operators, at \$4,030 per year. Applicants must be American citizens, male, and between the ages of 18 and 56, although the last qualification may be waived for veterans.

Duties will consist of regular ship operators' work aboard ships whose voyages will average about 90 days and whose home port is New York. Radar and some clerical work may be required. Subsistence and quarters are furnished, except during leaves.

Minimum entrance requirement is possession of a radio officer license issued by the United States Coast Guard. Holders of FCC first and second class radiotelegraph licenses will be per-

mitted to file applications, and their FCC tickets will assist them in getting the Coast Guard license. All applicants considered for appointment will be given a special examination on radio law, theory, and practice. Minimum code speed required is 25 words per minute.

To apply, obtain application Form 57, at any first or second class post office in which this notice is posted; from the Employment Branch, Industrial Relations Division, Military Sea Transportation Service, Atlantic, 58th Street and First Avenue, Brooklyn 20, New York; or from the Director, Second U.S. Civil Service Region, Federal Building, Christopher Street, New York 14, N. Y.

MORE NEW TRENDS IN '51 TV

Continuing last month's discussion of recent trends in TV, the author describes the latest in tuners and in focusing and centering coils

By **WALTER H. BUCHSBAUM**

Television tuners, once the Achilles' heel of the TV receiver, must cover two widely separated frequency bands and provide 6-mc bandwidth and some r.f. gain. By 1950 many different tuners had been tried, and many had been discarded.

A printed coil tuner is used in at least one make of 1951 receiver. Containing the basic features of the well-known Standard Coil turret tuner but having many differences circuit-wise, the printed coil unit features copper spiral coils printed on individual Bakelite strips and mounted in a 12-position turret switch. Because printed coils can be held to very close tolerances, only the oscillator coil is adjustable by means of a screwdriver inserted from the front of the chassis and alignment is much simpler.

Another novel feature of this tuner is its antenna input which contains a special bifilar matching or elevator transformer, permitting either 300-ohm balanced or 72-ohm unbalanced input. To change from one to the other the wiring of a small plug is changed. This permits the use of standard 300-ohm ribbon or 72-ohm coaxial cable where extreme noise or low-impedance antennas make this desirable.

A 6CB6 r.f. amplifier is used and a 6J6 as oscillator and mixer. The alignment of this unit is somewhat complex and the manufacturer's instructions should be followed closely. While early models suffered from poor switch contacts, this has been improved and now both electrical and mechanical performance of the printed coil tuner are satisfactory.

Another tuner, the RCA KRK8, is used in the 1951 RCA line and is an improvement over the 1950 switch-type model. Using only two tubes, a 6CB6 r.f. amplifier and 6J6 oscillator and mixer, this tuner makes use of the Miller effect to improve reception on weak signals. The r.f. amplifier contains a cathode resistor and capacitor of such value that when grid bias varies, the grid-to-plate capacitance of the tube also varies.

In ordinary amplifiers this effect is counteracted by inserting a small, un-bypassed resistor in series with the cathode. On weak signals, the low grid bias causes the input capacitance of the tube to detune the antenna input coil so as to raise the picture carrier slightly above the sound carrier. This

gives slightly better signal-to-noise ratio on weak stations.

A new and deluxe version of the Du Mont Inputuner was described in *RADIO-ELECTRONICS* for December, 1950. Four tuned circuits are used, providing excellent sensitivity and full coverage of the TV and FM bands in one continuously tuned system. Various dials are used with this tuner, and the complexity of most of these dials is probably its only drawback. The spiral coils molded in a high-grade insulating material, silver contact arms of improved design, and a solid mechanical construction make this the Cadillac of the TV tuner field.

The circuit of the Du Mont tuner is rather intricate. The r.f. signal is connected to the cathode of the r.f. amplifier, a 6AK5 in many models, but a bifilar transformer, like the one used in the printed-coil tuner, permits either 300-ohm balanced or 72-ohm unbalanced input. Tracking adjustments for all four tuned circuits are relatively simple and, once the unit is tracked, no further adjustments are necessary.

Du Mont also has a less expensive unit using three tuned circuits and operating basically like the deluxe model. Featured with this economy model is a simplified slide-rule scale which makes tuning the receiver much easier.

Another new tuner is the single-tube unit manufactured by Variable Condenser Corp. This tuner, found in Tele-tone, Emerson, and other receivers, uses one half of a 12AT7 as r.f. amplifier and the other half in a special oscillator-mixer circuit. The tuned circuits consist of printed spiral coils mounted on insulating material which forms the stator plates of a variable gang capacitor. The rotor plates are copper, closing down on the flat coils. As more of the coil is surrounded by copper, the inductance of the tuned circuit is reduced, changing the frequency accordingly. An automatic switching arrangement switches from high- to low-band coils. Simple to align and operate, this tuner performs well in local areas. Its sensitivity is not as good as that of more elaborate types.

Several other tuner manufacturers have announced new models which can be expected to appear in the TV sets of 1951. Most of these, like the tuners of Radio Condenser Corp., A. Lytel Co., etc., will be improved versions of earlier

models. Probably the most widely used tuner in 1951 will be the Standard Coil turret tuner. The same tuner was used by many different manufacturers in 1949 and 1950 and has proven reliable in most locations.

Focus and centering

In some 1950 receivers a combination EM-PM focus coil was used. This consists of a permanent-magnet ring with a coil inside. The PM ring furnishes most of the flux for focusing, and the coil, drawing about 30 to 40 ma, just adds enough flux to permit control over the entire flux. These combination focus coils caused some trouble because the magnet ring would change its flux and the flux due to the coil would be insufficient to compensate for the change in the permanent magnet.

A new, all-PM device is featured in all 1951 RCA, Philco, Stewart-Warner, and many other models. It has three properly aged Alnico pieces and two iron rings with the air gap adjustable through a flexible shaft driving a concentric iron tube. Some models adjust the air gap through large iron screws and use a flexible shaft for the centering device.

The centering device is essentially an iron ring which is part of the magnetic circuit of the focus device, but can be moved with respect to the tube neck. Effectively this device shifts the magnetic field of the focus coil, eliminating the need for shifting the entire structure, the disadvantage of previous mechanical centering by tilting the focus coil.

Summary

Fewer critical and troublesome circuits promise a relief from many TV headaches for the service technician. On the other hand, shortages of parts, especially tubes, will force manufacturers to make frequent substitutions. Knowing which tube can be substituted for which, what resistors are critical and which capacitors must be molded or oil filled, will be one of the most important problems for the serviceman. The television receiver of 1951 will differ from all its forerunners in giving the customer better performance at lower cost. The swing to rectangular picture tubes, high-efficiency flyback systems, and many other improvements will all add up to bring television into many more homes in 1951.

Box-Office Television

By

RICHARD H. DORF

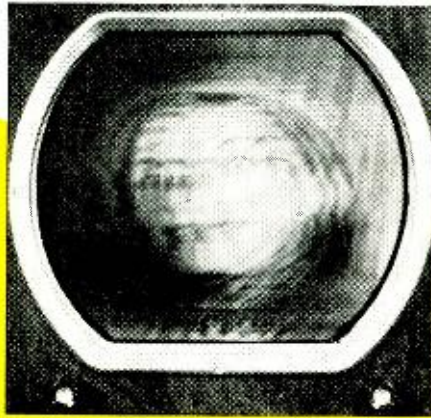

Photo A—Jittered transmission gives a multiple-ghost effect with bad flicker.

Subscriber-Vision would permit paying tele-viewers to watch first-run movies or stage plays



Photo B—Inserting the decoder gives perfect pictures from the jittered image.

BOTH the television industry and the FCC have long known that certain programs, such as first-line motion pictures, some sporting events, and Broadway plays, are too expensive to present on advertising-sponsored TV. Neither station nor advertiser could pay producers and promoters enough to make it worth their while. The obvious answer is box-office television, with the viewer paying a fee for each program or series of programs he wants to watch. Such a system could work side by side with ordinary commercial television. Most programs would

be presented without charge, as they are at present, but a few hours a day would be set aside on one or more stations for special programs, for which viewers would pay, probably on some sort of subscription basis.

The prime technical problem is to prevent viewers who have not paid from watching these programs, while allowing those who have bought their "tickets" to receive perfect pictures. To solve this problem, a new system known as Subscriber-Vision has recently been introduced by Skiatron Electronics and Television Corp. and is now undergoing tests over WOR-TV, New York. *Subscriber-Vision* is an interesting and ingenious development from the technical standpoint. It has certain advantages over Phonevision, the system proposed by Zenith, and may turn out to be of great value for military use as a method of transmitting television images without interception by the enemy. The system now under test has been developed using as a starting point a patent by Dr. A. H. Rosenthal, inventor of the revolutionary Skiatron or dark-trace tube (see RADIO-ELECTRONICS, March, 1949, page 36).

How Subscriber-Vision is used

The principle of Subscriber-Vision—like that of Phonevision—is to scramble or "jitter" the picture in such a way that a receiver not equipped with special apparatus shows a picture that cannot be watched. The actual procedure is to make the picture move from side to side on the screen at a high rate of speed. As can be seen in Photo A, the result looks like an image with multiple ghosts, each ghost just as strong as the original or main image. In addition, the

jittering rate is slow enough to make the screen seem to flicker.

The picture can be made to stand still if a specially punched card is inserted in a small decoding device attached to the receiver. The picture is jittered at the transmitter by displacing the horizontal sync pulses in a pattern which can be altered at will. If the card at the receiver has its holes punched at the correct points, the horizontal sync pulses at the receiver are displaced in synchronism with those at the transmitter and the image stands still.

The principal superficial difference between Subscriber-Vision and Phonevision is this decoding method. Subscriber-Vision utilizes the punched card; Phonevision unscrambles by sending a signal over telephone wires. Connections must be made from the subscriber's telephone box to the TV receiver and the telephone company must patch the unscrambling signal on request, then compute charges. In Chicago, where Phonevision tests have been made, the telephone company has expressed unwillingness to cooperate because of the necessary changes in its equipment and the necessity of handling the accounts, among other reasons. Party lines present a special problem.

Another difference is—with present setups, at least—that Phonevision jitters the picture back and forth between just two positions, while Subscriber-Vision uses four positions in present tests and can easily use more, making unauthorized unscrambling more difficult.

How Subscriber-Vision works

As noted, the image is jittered from side to side by displacing horizontal sync pulses. Under the present system

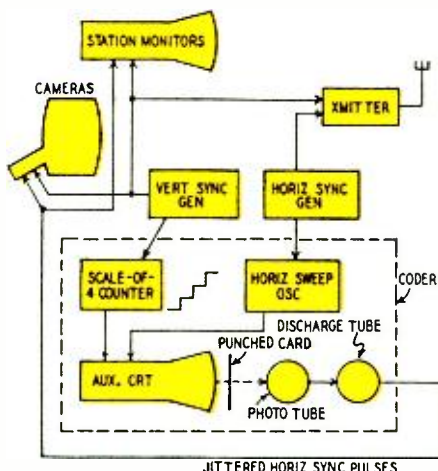

Fig. 1—Block diagram of the Subscriber-Vision coder used at the transmitter. The coder appears within dashed box. The only important changes made at the transmitter are to widen every fourth vertical sync pulse and to sync the cameras' horizontal drive from the phototube output rather than from station generator, thus coding the image.

the pulse position could be changed once every line, once every several lines, every field, every frame, or in any reasonable combination. The rate to be used has not been settled finally, pending psychological tests to find which is most effective.

We shall describe the method in use in the WOR-TV tests which began in October, 1950.

Fig. 1 is a block diagram of what happens at the transmitter. Horizontal and vertical sync generators which provide sync pulses to the cameras, monitors, and transmitter are altered slightly in only one respect: every fourth vertical sync pulse is widened a little. This does not affect normal operation at either transmitter or receiver. In addition, the cameras no longer receive horizontal sync pulses from the station generator, but instead from the special coder unit which appears within the dashed box.

The coder contains an auxiliary 2-inch cathode-ray tube on which a pattern of four lines appears, as in Fig. 2.

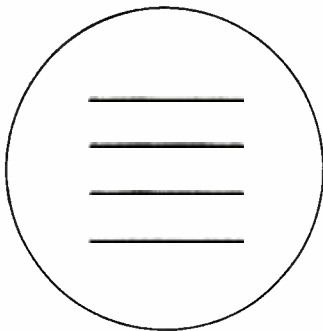

Fig. 2—Four-line pattern on C-R tube.

To create the lines horizontal sync pulses from the station generator operate a horizontal sweep circuit within the coder. This makes the spot move horizontally once for every line of a standard TV picture. During one field of ordinary transmission, then, the spot moves horizontally $262\frac{1}{2}$ times.

The spot in the small cathode-ray tube traverses each line $262\frac{1}{2}$ times during one field, then does the same thing with the next line. After covering four lines it repeats the process. Its vertical position is determined by a special vertical positioning circuit consisting of a scale-of-four counter with the step-type waveform shown beside it in the block diagram of Fig. 1. During one field, the vertical position voltage (output of the counter) may be at its lowest value. The next vertical sync pulse, which occurs just before the next picture field, raises this voltage to the next step; the next vertical pulse raises it again; and the third vertical pulse raises the voltage to maximum. The fourth vertical pulse is a wide one and brings the counter output voltage to the starting point, where the cycle begins over again.

In operation a punched card is placed between the screen of the small cathode-ray tube and a phototube. The card over the screen looks like that in Fig. 3. in

which the dashed lines indicate what is hidden behind the card. Each time the scanning spot passes a hole in the card its light goes to the phototube, producing a pulse of output. Since the spot moves horizontally at the same rate as the spots in camera and receiving tubes, one pulse of output from the phototube is produced during each standard picture line.

The output of the phototube is fed to a discharge tube which shapes the pulses so that they may be used to operate the station's horizontal drive which supplies sweep voltage to the cameras and monitors. The timing of the pulses depends on only one thing—the position of the hole in the card along the particular line being scanned in the auxiliary cathode-ray tube. Thus, during the first fields, a horizontal sync pulse is produced whenever the spot passes hole A and the camera begins every line in that field at the same time. During the second field hole B determines the time each line starts, and so with holes C and D during the third and fourth fields.

If all lines began at the same relative time, no matter what that were, the picture at home could be watched. While the picture would be off center, that could be fixed by changing the positioning adjustments on the rear of the set. But the relative timing is changed every field—every $\frac{1}{60}$ second—and no one could readjust controls that fast! So the picture moves from side to side and watching is impossible.

Making the image stand still

The first requirement for each subscriber is a decoder attached to his receiver. The decoder is block-diagrammed in Fig. 4 and is almost identical to the coder used as the transmitter.

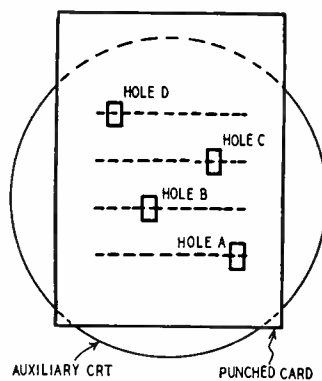

Fig. 3—When a punched card is placed over the small C-R tube, light pulses pass to the phototube only when the scanning spot strikes one of the holes.

From the sync separator, the standard vertical and horizontal pulses received from the station go to an auxiliary cathode-ray tube. With the aid of a scale-of-four counter, the now familiar four-line pattern is produced. The vertical sync pulses go as usual to the viewing tube as well as to the decoder, but the horizontal sync pulses do not go to the horizontal oscillator. They are

used only to create the four-line pattern on the small cathode-ray tube, just as at the transmitter.

A punched card is placed between the small tube and a phototube. If it is punched exactly like the one at the transmitter, it allows light pulses to create output pulses from the phototube at exactly the same instant as those being produced at the station for the cameras. The pulses, after being shaped by a discharge tube, are fed to the receiver's horizontal oscillator. The end result is that the receiver's horizontal sweeps always begin at the same instant as those at the station's cameras and the picture stands still. To change the coding, a card with different punching is inserted into the station's coder; to obtain this picture, the subscriber must buy a similarly punched new card.

The status of Subscriber-Vision

Although the basic patent for Subscriber-Vision is dated 1941, it was delayed by a business affiliation which prevented its development. After the corporation was freed from this affiliation by the successful conclusion of an anti-trust suit, several months were required for additional technical work. It is now ready to go but must first be demonstrated to and approved by the FCC and the public. As the first step in that direction the equipment was set up at the transmitter of WOR-TV. At this writing (late December, 1950) the system just has been put on the air for limited confirmatory engineering tests. Following those the members and staff of the FCC are expected to examine it and eventually to render a decision.

The photographs on these pages were taken at WOR-TV. Photo B, taken directly from a receiver screen, shows transmission while the picture was being jittered but with a decoder and the correct card in use at the receiver. Photo A was taken with the card removed; this is the image nonsubscribers see.

Photo C shows the decoder used with the receiver of Photos A and B. This is an experimental model; the final ones will contain fewer tubes, will simply plug into the sync-separator-tube socket of a standard TV receiver, and may even do without auxiliary C-R tube, depending instead on an "electronic commutator" now in development. Of great

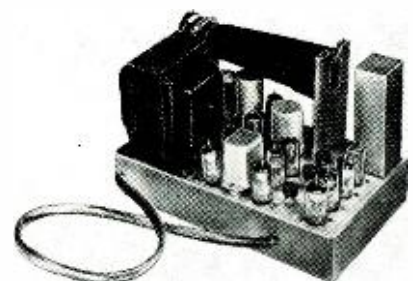

Photo C—Decoder unit used to make the image stand still in Photo B. Production models will have fewer tubes, perhaps no C-R tube; will attach to standard sets.

interest at this time is the fact that Subscriber-Vision will operate with color television just as well as with monochrome. It is ideally suited to the CBS field-sequential color system recently adopted by the FCC. Used with color, scrambling will be even more complete than with black-and-white, since the horizontally displaced fields will completely upset the color registration. The jittered picture will appear much as would the cover of RADIO-ELECTRONICS if the printer, instead of placing his red, green, and blue plates so that their impressions on the paper register, deliberately made one plate print way to

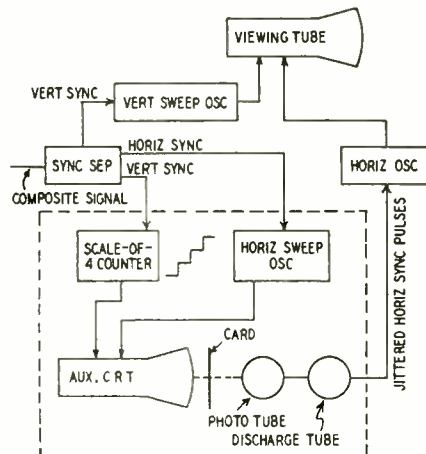
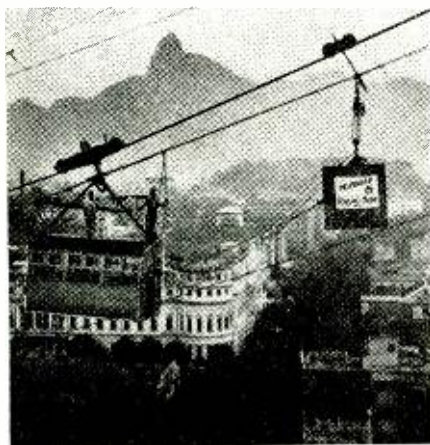

Fig. 4—The decoder (in dashed box) used at the receiver is almost identical to the coder at the station. It jitters the horizontal sync pulses fed to the viewing tube in synchronism with those fed to the cameras, thus makes the image on the screen of the receiver stationary.

the left, another way to the right and another in between. Faces might be red and carpets flesh color, clouds rack-cabinet gray and equipment sky-blue. Worse yet, since the CBS system uses three colors, while the Subscriber-Vision jitters the picture in four-field patterns, at least in the present tests, the colors, hues, and shades of everything in the picture would constantly be changing!

RIO'S TV IS ON MOUNTAIN



Photograph Courtesy General Electric Co. Cable car is used to move equipment to Rio de Janeiro's new TV station on the top of 1,300-foot Sugar Loaf mountain.

Television Service Clinic

Conducted by
WALTER H. BUCHSBAUM*

The flood of mail of recent months has resulted in an occasional slowdown in answering all of your letters for which we apologize sincerely. We have, however, increased our facilities and are now able to give you the same prompt reply as in previous months. Those of you who have big-tube conversion problems can get all necessary data by sending a self addressed, stamped envelope to your TV Service Clinic and stating the make and model of the set.

Next to conversion problems the largest number of inquiries concerned recent color articles in this magazine. To clear up some frequent misconceptions about the field sequential (CBS) color system we submit the following definitions and data.

Color adaptor: a number of circuit changes to let the black-and-white receiver operate at the sweep frequencies of the CBS system. *This gives a black-and-white picture.*

Color converter: either a separate viewing unit or an adaptor plus color wheel with motor and synchronizing devices. *This produces a color picture.*

Fold-over on color pictures: When adapting a present set to the sweep frequencies of the CBS system it is found that the retrace time of the color picture is much less than for the black and white one. (See January RADIO-ELECTRONICS.) The flyback transformer, deflection yoke and circuit components of the black-and-white set have an inherently longer flyback time. This results in fold-over when a color picture is being received. Only by changing the components to special color types can this be eliminated.

Flicker on color pictures: This is usually due to a 12-cycle beat between the 60-cycle line frequency and the 48-cycle picture frequency predominant in a color picture. The only way to eliminate or reduce it is to remove all of the a.c. hum from the B-plus supply. Improved filtering, decoupling and physical isolation of the video section and picture tube will reduce flicker. Occasionally the heater-cathode leakage of an i.f. or video amplifier tube also adds to the flicker.

Flat pictures on black and white: Color photography requires flat lighting, while black and white makes use of shadows, highlights and reflections. The same holds true in TV. When color pictures are viewed on a black-and-white receiver, they will appear flat and lacking in eye-appeal.

General conversion difficulties: Converting an electrostatic TV set to color is not nearly as difficult as doing the same on a magnetically deflected receiver. To

get good results with big picture TV sets it is best to install a new flyback transformer, yoke and possibly a different vertical output transformer. As in the past, TV Service Clinic will continue to answer all your questions by direct mail first and then print those which are of general interest. This includes questions on color television as well as all other phases of the television industry.

Picture too small

I converted a 10-inch RCA 721 TS receiver to use a 14CP4 and also added a 70° deflection yoke. Now the picture does not fill the size of the tube.—A. Augustine Radio, Kearny, N. J.

Besides the 70° deflection yoke, you probably also need a suitable flyback transformer. We recommend that you use a conversion kit such as the Techmaster Hi Sweep, which contains all the parts and instructions.

Try shunting the width coil with a .05 µf capacitor. Reduce the 6BG6-G screen resistor to 6,800 ohms (2 watts), connected to the B-plus line. Reduce the plate resistor of the horizontal oscillator tube (6SN7-GT) and readjust the coil for synchronized picture.

Fuse blowing

Sound was O.K., but the picture went out on an Admiral 20X12 TV set. I discovered the ¼-amp, 250-volt fuse was blown, and, having no replacement, remedied the defect by shorting the fuse with a piece of wire. After a few days the picture went out again, but the sound was still O.K.—G. A. Babcock, Tarrytown, N. Y.

The fuse probably blew because of arcing or some other defect that caused excessive current through the flyback transformer. By shorting the fuse, you allowed the excess current to continue, and this probably caused the flyback winding to open or the output tubes to go bad.

A complete voltage and continuity test of the flyback section may be necessary to locate the defect.

Yellow spot on 19AP4

I have a set with an ion spot on the 19AP4 picture tube. Please tell me how to adjust the ion trap and what kind of magnet to use.—W. A. Sylvester.

This tube uses a single magnet trap. It has a bent electron gun and if the trap is misadjusted, a complete picture cannot appear. All ions are trapped out by the gun and cannot reach the screen. Thus this yellow spot cannot be removed and you must get a new tube. As most tubes are guaranteed for one year, we suggest you contact the manufacturer.

* Author of *Television Servicing*, Prentice-Hall Inc., 1950

A TECHNICIAN is inclined to be a skeptic; he seeks the proof positive. So far as antenna gain figures, antenna patterns, and the continuous stream of claims and counterclaims for the multitude of television antennas are concerned he is left bewildered. What to believe!

With simple instruments and a test setup he can evaluate the performance of various types of antennas and antenna systems. If he is constructing a homemade high-gain antenna for a long-range custom job, he can use this plan to obtain optimum dimensions and proper matching.

The system consists of a reliable signal generator, an inexpensive field-strength meter (such as *Transvision* or *Approved*), a multiplicity of reference dipoles and antennas under check. As a signal generator we found it convenient to use the Triplett 3434 signal generator marker because of its accurate calibration and substantial signal output.

Interconnection plan

A block-diagram interconnection plan is presented in Fig. 1. Transmitting and receiving positions are approximately 50 to 100 feet apart. Separation depends upon output of the signal generator and sensitivity of the field-

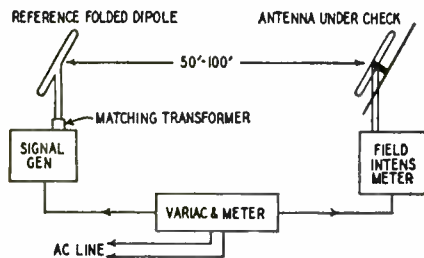

strength meter. Choose a separation that produces about one quarter to one third full-scale deflection, using a reference folded-dipole receiving antenna. When a high-gain receiving antenna is substituted for the reference dipole, a good indication is obtained. Keep antenna heights in the same horizontal plane as far above ground as possible (minimum height should be 20 feet).

For accuracy, use a Variac to keep the line voltage constant as supplied to the signal generator and field-strength meter.

Cut two reference folded dipoles (one for transmission and a second as a reference receiving antenna) on each channel with which you are concerned. Or if you are interested in checking antennas on all channels a complete set of reference antennas must be cut (Table I).

Antenna-gain check procedure

An antenna gain check can be made by recording the field-strength meter reading when using a reference folded dipole at the receiving position. Use 300-ohm transmission line and 300-ohm input into the meter. Now substitute

*Television Instructor—Technical Institute, Temple University.

Simple Test Method Evaluates Antennas

By EDWARD M. NOLL*

for the reference dipole the antenna to be checked and record the new reading. From meter readings and the field-strength chart calculate the voltage ratio of the antenna under check to the reference dipole.

Table I—Folded Dipole Dimensions

Total Length of Tubing			
Channel	Inches	Channel	Inches
2	200	8	62.6
3	181	9	60.6
4	166	10	58.7
5	145	11	57
6	134	12	55.3
7	64.7	13	53.8

Voltage ratio can be converted to a db-gain figure by using formulas or an approximation can be obtained by referring to the chart (Table II). Go through the same procedure to obtain the db-gain figures for each channel. Be certain to use the proper reference dipole for each channel checked. Use the same length of transmission line between reference dipole and field-strength meter as you do between the antenna which is being checked and the meter.

Excellent results can be obtained if the signal generator can be located very near the transmitting antenna. Try to position the generator and antenna on a roof or platform so they are just a few feet apart and the output of the generator through the transformer goes directly to the antenna without any appreciable length of line between. If the antenna and generator must be separated, be certain a good match is retained and there is a very minimum of radiation from the transmission line.

Set the signal generator frequency carefully to the center frequency of the channel antenna to be checked. Most published gain curves are based on reference dipoles cut to channel center frequency. If a long-range matched

antenna is being constructed, cut reference dipoles for picture carrier frequency as it is a common practice to favor picture over long-distance reception of TV signals.

Antenna pattern check

Equipment is arranged in exactly the same manner to obtain readings for an antenna plot. A complete set of readings must be taken through 360 degrees to obtain data for a polar plot. First reading is taken when elements of the receiving antenna are parallel with the transmitting dipole. This represents the 0-degree reading. Now rotate the antenna, taking a reading every 15 or 20 degrees.

If readings are in microvolts, they can be plotted directly on polar paper (Fig. 2). If readings are relative meter scale, convert to microvolts with the manufacturer's chart and then plot on polar paper.

This polar plot gives a true indication of the antenna's performance because a TV receiver functions on the basis of voltage delivered to its input. A voltage ratio plot can be made by letting the maximum reading represent one (locate this point on the outer circle of the paper) and all other points a decimal part of it (Fig. 2).

Most manufacturers' charts are not in terms of a voltage-ratio polar plot (more indicative of antenna performance) but in terms of a power-ratio plot which produces a much better-looking curve.

Regardless of published data or lack of it, an antenna can be put through its paces with the above simple procedure. It is of great assistance in helping to decide if a certain antenna type meets your needs.

Table II—Db Chart			
Db	Voltage Ratio	Db	Voltage Ratio
0.5	1.06	5.5	1.80
1	1.12	6	2
1.5	1.19	6.6	2.1
2	1.26	7	2.24
2.5	1.33	7.5	2.35
3	1.41	8	2.5
3.5	1.49	9	2.82
4	1.58	10	3.16
4.5	1.67	12	3.98
5	1.78	15	5.62

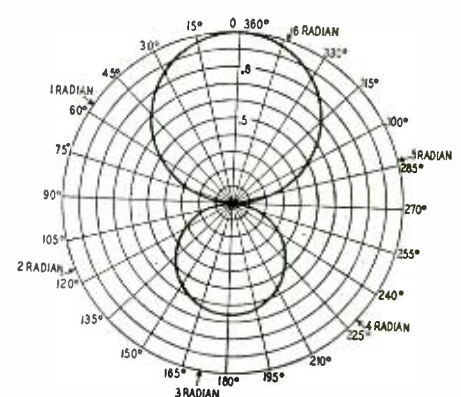

Fig. 2—Polar plot of antenna pattern.

Facts of the Color TV Dispute

By JACK GOULD*

IF THE television-viewing public is bewildered and bothered by all the many facets to the color controversy, it has every right to be. Seldom has a dispute embraced so many complex issues, each one of which has the makings of a good row in itself. These issues cover extraordinarily complicated engineering factors, economic problems, fundamental concepts as to the role of government *vs.* free enterprise, and, last but by no means least, the individual who is, or expects to be, watching television.

Under such circumstances, pat and glib statements as to what the color controversy means to John Doe are unwise. The best that can be done is to take up the controversy step-by-step:

What the FCC is: The Federal Communications Commission was set up by Congress to deal with the involved engineering problems upon which it was impractical to legislate.

The commission's fundamental responsibility is to see that broadcasting

is conducted in "the public interest." Its power lies in the license which a station must have to use a wavelength that belongs to the public as a whole.

What the FCC did about color: The commission conducted lengthy hearings to investigate the merits of several color systems, of which the most publicized have been those of CBS and RCA.

The FCC finally decided that the CBS system gave pictures which were sufficiently perfected to be introduced commercially. That the pictures are extremely good and far superior to black-and-white cannot be denied; they are. This all-important point has been rather seriously overlooked in the general controversy to date.

Until there are additional demonstrations of the CBS color, it must be acknowledged that the general public has not seen with its own eyes what the FCC has indorsed. Despite the manufacturing industry's unfavorable reaction to the FCC approval, the public's reaction to watching CBS color has yet to be registered.

As for the RCA system, the commission decreed that it was inferior in quality and not easily operated by the average layman. It also expressed doubt that certain technical difficulties could be overcome.

The FCC's primary objective has been to bring about the introduction of a service in color. It generally has been less concerned with the maintenance of a service in black and white, upon which most manufacturers have placed major emphasis since the commission's approval of CBS color on Oct. 11.

Why the FCC action causes such strong reaction: CBS, which is not a manufacturer of either receiving or transmitting equipment, played a lone hand in the color hearing. The overwhelming preponderance of engineers and set manufacturers were against the CBS system on both technical and economic grounds.

The causes underlying the conflict are these:

The CBS color system: Basically, the CBS system is technically incompatible with the television that is broadcast today. To receive a CBS color picture in black and white on a present set, it is necessary to have an adapter. To receive a CBS color picture in color on a present set it is necessary to have first an adapter and then a converter. The adapter alone would run to about \$35; the adapter and converter, at least \$100 and very possibly substantially more.

An adapter is a device which electronically alters the circuit of a set so that it can accept in black-and-white a picture transmitted by CBS in color. Without the adapters the color image appears on a present set only as meaningless lines.

The converter is the device which introduces the actual color. Its physical appearance and operation have been major points of controversy. Under the CBS system, the primary TV colors of red, blue and green, are injected by a filter disc which is spun at high speed by a small motor. This disc is placed directly in front of the camera and receiving tubes.

The disc is a limiting factor on the picture size. Since only half of the disc passes in front of the tube at a given moment, it must be roughly twice as large as the picture. From the practical standpoint the disc is limited to about 25 inches, which gives a picture of 12½ inches, already an outdated size in today's sets. With a magnifying lens it can be brought up to 16 inches, a more popular size.

It is possible, however, to use the rotating discs with larger screens, such as the 19-inch, etc. But the maximum



A spinning color wheel must be put in front of the screen in the CBS system.

picture still will be 12½ inches before magnification.

The CBS system, however, is not dependent on the spinning disc as such. When the primary colors are introduced by electronic means, this means can be incorporated in the CBS system, thus eliminating the disc.

Appropos the CBS converters, one manufacturer in favor of the Columbia system is planning a device which would enclose an adapter, converter and separate tube in a single cabinet. This separate cabinet would hide the unattractive spinning disc.

The RCA Color System: This system is designed to be compatible with present television. To receive an RCA color program in black and white on a present receiver no adapter is necessary. The same transmission will produce a black-and-white image on a black-and-white receiver and a color image on a color receiver.

To receive an RCA color program in color on a present black-and-white receiver a converter must be employed. The heart of both the system and this conversion process is an electronic tricolor receiving tube which injects red, blue and green. The tube would provide both color and black-and-white pictures, electronically projecting on the screen whichever of the two types of transmission happened to be employed by a station.

The RCA conversion might cost about \$175, including the labor of the skilled service man required to do the job. This figure, however, admittedly is only a guess.

The FCC-reasoning: The commission has been anxious to authorize color. Its advent is regarded by all parties concerned as inevitable. The FCC wanted to make the move with least inconvenience and expense to the public.

Primarily, the FCC was of the opinion that the RCA and other all-electronic systems would take an unspecified period of time to be brought to the state of perfection of CBS color. Even then, it was not sure that such electronic systems would be free from operating difficulties. By strong implication, at least, it has suggested that the anti-CBS manufacturers were indulging in delaying tactics so that the public first could be sold black-and-white receivers and then color sets.

Accepting these premises—and each is vigorously disputed by the set manufacturers—the FCC was thinking more in terms of what might happen to tomorrow's theoretical 80,000,000 set owners than today's 8,000,000. If it kept postponing a decision, the problem merely might be magnified manifold.

Reasoning of the manufacturers: The manufacturers hold that the FCC is unrealistic and impractical. They offer the analogy that if one wants to improve service on the railroads one concentrates on building a new type of engine; one doesn't change the gauge of the tracks so that none of the present coaches will be useful without "adapting" their wheels to a new base.

In effect, they maintain that the FCC has seriously retarded color because the CBS system does not provide for the simultaneous maintenance of black-and-white service while color is introduced.

From the economic standpoint, they argue, the FCC's protection of the public's pocketbook is largely illusory. The cost of converting an existing set still must be met by the consumer, who even after this additional outlay, doesn't have the latest, most attractive, most efficient set—a new, factory-made receiver.

The manufacturers aver further that protection of the public must be seen from the long-range point of view. CBS color is not going to stop developmental work on a compatible system, they say, and there is a possibility of two transitional upheavals instead of only one. Technically, they add, the spinning disc was tried and discarded in the early days of black-and-white and they foresee the same course of events with CBS color, as even CBS acknowledges may happen. Then a CBS disc converter itself will become obsolete, they note.

In short, the manufacturers insist that the ultimate potentialities of compatible all-electronic color outweigh whatever immediate practical gains the CBS system afford. And they state further that unlike either the FCC or CBS they must cope with all the retooling, competitive merchandising and employment problems which are the lot of a major manufacturer.

Why Present Sets Will Have Extended Usefulness: Both the manufacturers and CBS are agreed on one point: The set now in use will give service for a number of years to come. It will not become a piece of junk to be

put out with the morning trash.

The reasons for this are many, primarily economic. Under the CBS system, it will be necessary to build up a color audience from scratch.

But with production costs constantly mounting, it is not logical to assume sponsors of major programs will sacrifice the present total potential audience of 30,000,000 for the comparative handful of families who at the start may purchase converters. CBS concedes that it will have an uphill fight to take its color system over this transitional hurdle, particularly since many individual television stations are still operating at a loss.

From *The New York Times*, October 22, 1950



Experimental color slave demonstrated by S. W. Gross, president of Tele-tone.

MATCHING PADS FOR TV SETS

Several TV sets can be operated from a common antenna in strong-signal areas where some reduction in signal strength can be tolerated. Matching pads maintain the impedance match between each set and the transmission line to the antenna. This matching network, described in Stromberg-Carlson's *Current Flashes*, can be used for up to eight receivers having 300-ohm input terminals.

The diagram shows the connections to three receivers. R1 is 220, 390, 560, 820, 820, 1,000, and 1,200 ohms for two to eight sets, respectively. R2 is 470 ohms for two sets, 390 for three, and 330 for four to eight sets. Noninductive carbon resistors should be used. It is advisable to place them at the junction of the transmission lines rather than at the receiver terminals.

The pads have a tendency to reduce front-end radiation for they attenuate signals passing through them in either direction. In many cases, the interfering signal will be reduced to the point where it is not noticeable on the screens of nearby receivers.

The matching pads can be mounted

at such a point on the transmission line from the antenna that the branch lines to the individual sets are approximately the same length. The resistors may be mounted on insulated terminal strips installed in a small metal shield box which will protect them from accidental breakage.

If this arrangement is used in a television showroom where one or more of the receivers may be temporarily disconnected from the antenna, the open ends of the branch lines should be shorted with 330-ohm carbon resistors to prevent a mismatch to the lead-in and other sets.

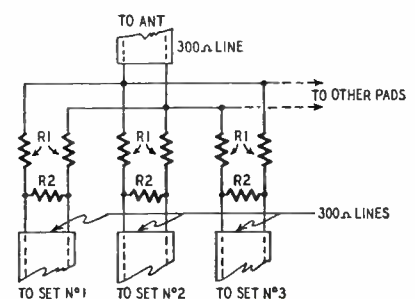

Television DX Reports

If this does not produce results, a shorted filter capacitor or grounded choke may be the trouble.

If everything seems to be running fairly cool, a voltage divider or other circuit may be open. If it is a voltage divider the trouble can be fixed on the spot if the power supply can be removed and inspected easily. Otherwise, tracing the divider network in a single-chassis set is better left to the bench.

Poor sound on one channel. Remove the channel selector and fine tuning knobs and trim the oscillator adjustment from the front (this is not possible on all sets). Do this very carefully because a large change in the oscillator adjustment will require trimming all of the channels on some tuners. Always check all channels when trimming the oscillator adjustment to be sure that you have not done more harm than good.

No pix, no sound, but brightness. Check the tubes in the tuner.

Interference problems. The answers to this are very indefinite unless a great deal of time is spent in locating the source of the interference and curing it at that end. Mild forms of interference often may be reduced by using a piece of 300-ohm line as an open-end stub at the antenna terminals. The length of the stub in feet is found (to a first approximation) by dividing 246 by the frequency (in mc) of the interfering source. The stub may be cut in half and closed to avoid having an unsightly length of wire behind the set.

Interference sometimes can be eliminated by connecting a piece of 300-ohm line to the antenna terminals, and, starting at the end away from the set, shorting the line every few inches. If the interference disappears at one point, clip the line and short it. Check the other channels for possible attenuation caused by this stubbing.

Conditions that the fine tuning control and oscillator adjustment will not clear up are probably due to misadjustment of some of the tuned circuits and are best left to the service bench.

If the signal level is weak on one station, wrap a piece of tinfoil around the 300-ohm line near the antenna terminals and slide it outward. Note the point where the picture brightens and leave the tinfoil clipped at this point if it does not cause attenuation on other channels.

In most service organizations the actual repair of the set is not as important as the ability to determine whether it can be repaired outside by the service technician or whether it must be removed to the shop. The procedure given in this article suggests a quick and efficient basis for making this decision.

The service technician will run into many different situations, such as different types of power supplies, intercarrier, etc., but this information covers a large number of the more popular present day sets.

Propagation of TV frequencies is definitely down with the approach of winter. Our reports of 1,000-mile dx for October and November number only five. Most original of these is a "south of the border" report. William Bashta, of Bill's Radio and Television Service, Los Alamos, N. M., heard XHTV, Mexico City, between 7 and 9 pm November 28, using an Admiral 34R15 with a Tel-A-Ray model T antenna cut for channel 4. A rotator was used.

The champion station KPRC-TV of Houston, Texas, was received by three of our reporters. H. W. Coffman of Urbana, Va., heard the station on November 30, from 7:10 to 7:30 pm, using an Arvin 8-inch receiver, a Jerrold booster and a double-stacked conical antenna. Another Virginian, Norman M. Pearson of Roanoke, heard it from 7 to 8:30 pm the next evening, December 1, using a K19 Midwest, with an Astatic A1 booster and 4-bay conical Skymaster antenna. Even greater distance was reported by John W. Sweigart, who heard KPRC-TV at New Holland, Pa., on November 23, at 8:10 am. Mr. Sweigart has a General Electric model 12C107 and a JFD Super Dx'er antenna with a Tennamotor.

A Texas listener, M. J. Lewis of Orange, received WMAR-TV of Baltimore on November 30 between 6 and 7 pm. The receiver was a G-E 805 and the antenna a home-built folded dipole. Mr. Lewis says that some nights, if he's lucky, he too gets KPRC-TV "with snow!"

Several delayed or consolidated reports of reception at earlier dates were also received. Among the outstanding ones was that of Richard L. Evans, Jr., of Ambler, Pa., who received WDAF-TV of Kansas City on a Du Mont with a Brach batwing antenna and an Alliance Tenna-Rotor, and that of David Shuirman of Flint, Michigan, who during the year received five Texas stations. He has a Sentinel set with a Masco booster and a Telrex array.

Another reporter, Stanley C. Sachse of Los Angeles, sends us a verification card from KPRC-TV, and Leigh Palmer of the same city sends us a photo of the WKY-TV test pattern received during interference from KDYL-TV of Salt Lake City.

A number of other reports, of reception less than 1,000 miles, were received during the month. These are all being added to our TV dx file, which is being used for a study of high-frequency propagation conditions.

Our 1,000-mile dx reports are put in the shade by the reports of the Panorama Receiving Station of the South African Broadcasting Corporation of Johannesburg, which listens systematically for the *sound channel* of the London (England) television station on 41.5 mc. The station was received reg-

ularly through most of the months of the last two years, reporting no reception only in July, 1949. Other months ranged from one report for June to "more than 50% of the observations" for March, October, and November, with April running close. Reception during 1950 has not been as good, but the London station was received on numerous occasions up to June, 1950, with no reception during June or July. The distance is over 6,000 miles!

Best months appear to be during the late fall and early spring over the London-South Africa path. No report was made on the picture, though South African observers are reported to have received pictures as well as sound from the London station. Television owners with older sets may be able to tune channel 1 down to 45 mc and try to receive British television signals here. Or try for the powerful Sutton Coldfield station (sound channel 58.25 mc; vision channel 61.75 mc).

Reception may be accompanied by difficulties, as British transmissions are on 405 lines and of positive polarity. By adjusting horizontal controls, the 4- and 6-figure patterns familiar to viewers of CBS programs will be seen, but because of the positive polarity of British transmissions, blacks and whites will be reversed. London uses double-sideband transmission, but Sutton Coldfield uses vestigial sideband.

The British sound is AM instead of FM, and will not be picked up by an American television receiver, but can be received on a shortwave radio. It is 3.5 mc below the video carrier.

TV SERVICE COMPLAINT

Complaints on the quality of TV sets delivered to the New York City area continued to increase during the fall. Several large retailers reported that practically every set had to be realigned, and service contractors said that workmanship was "rapid and poor" and was getting worse.

This unfortunate condition is a result of the manufacturers trying to get out as many sets as possible plus the fact that components shortages have made it necessary to substitute parts and make stop-gap changes in chassis design. One dealer association reported that over half the sets installed break down within a few days or fail to play.

Service companies, already overtaxed, complain that they are faced with parts shortages, lack of skilled technicians, inadequate telephone facilities, and some parts obtainable only at black market prices. Response to service calls now averages from three to five days, even in the largest organizations. In some cases sets have been held on the bench for as long as six to eight weeks awaiting new parts.

TV by the Sea

By ALVIN B. KAUFMAN

TELEVISION antenna installations along the seacoast present special problems because of the high moisture and salt content of the air. Antenna and lead-in corrosion itself is not too serious a problem, the main difficulty being the change of impedance and attenuation characteristics of the transmission line between antenna and receiver.

In locations right on the beach, the normal 300-ohm ribbon-line will be useless within a few days. Six blocks inland the line may last three months. The change of line attenuation can be insidious, occurring slowly enough so that as the picture becomes "snowy" the set is blamed.

Salt and moisture on the transmission line and the antenna insulators cause virtually a dead short circuit. During the day pictures are often passable; but as the night fog rolls in (yes, even in sunny California) and wets the deposited salt on the transmission line, the picture goes bad. This change of transmission line attenuation cannot be detected by d.c. measurements with an analyzer.

Obviously this effect is not so apparent in coastal cities with their own local TV stations, but down the coast 20 to 30 miles there is a difference. A similar situation exists in all our coastal cities more than 15 or 20 miles from a TV station. Catalog information is misleading. Line loss or attenuation per 100 feet at operating frequency is listed in db. As db is $20 \log E_0/E_1$, a few db loss may be 100% change in signal voltage, which actually determines video signal-to-noise ratio. In sound level this change is generally insignificant, but not so in video level.

The db problem is an important factor in choosing a suitable transmission line for coastal areas. An immediate solution appears to be the use of 300-ohm shielded transmission line. For installations using only a few feet, this may be satisfactory. But if 60 to 100 feet of transmission line must be used, especially in fringe areas, the increased attenuation of this type of line makes it as bad as standard transmission line ruined by weather. This has been verified by tests along the coastal area of Los Angeles.

The problem then is one of obtaining or modifying present transmission line to resist weather and salt without increasing its attenuation. Shielded polystyrene coaxial line by its very nature has higher loss than flat molded or open-air line unless it has excessive diameter, in which case impedances,

cost, and installation problems make it impractical. Open-air line has by far the lowest loss, if the correct spacers are used.

A commercial 300-ohm open-air line is manufactured by Gonset. For seacoast installations it is much superior to the standard molded lines, but even it will go bad in the worst areas in a few days' time. One "cure" for this line is to coat the spacers with silicone grease such as Dow-Corning DC-4 or Amphenol No. 307. The silicone grease sheds water; the droplets which form eventually fall off. As the spacers cannot become wetted down, there is no solid salt sheet across the spacers and consequently attenuation is limited.

Manufacturer	Cable No.	Impedance (ohms)	Size (inches)	Att. db per 100 ft (at 200 mc)
Amphenol	RG 8/U coax	52	0.405 dia	3.3
Amphenol	RG 11/U coax	75	0.405 dia	2.85
Amphenol	RG 17/U coax	52	0.870 dia	1.3
Amphenol	RG 57/U coax	95	0.645 dia	4.60
Andrew ²	83	70	1/2 dia	1.5
Andrew ²	737	64	1/2 dia	0.6
Belden ²	8225	100	0.19x0.31	12.0
Federal ²	K-51	95	0.340 dia	5.5
Federal ²	K-51	95	0.345 dia	6.0
Federal ²	K-111	300	0.29x0.43	4.6
Gonset	Open Line	300		0.5

¹Flexible coax, pressurized.
²Shielded pair.

Flat molded line also can be given this treatment, but it is impractical because of the long length that must be covered with the silicone compound. One available line has about 80% of the insulation material that separates the wire removed. This would use less of the compound.

Flat molded line can be greatly improved by slipping it inside large plastic tubing. As the plastic tubing becomes coated with salt, it effectively becomes a shield and increases the attenuation, but not nearly so badly as a directly coated transmission line.

Possibly the best answer for really bad areas is a flexible copper air- or nitrogen-pressurized coaxial line. Although the initial cost is much higher, averaged over a few years it may be much lower. Pressurizing the line prevents atmospheric changes from "breathing" moisture into the line. The cost with pressurizing will run from 25 to 50¢ per foot, depending on the ingenuity of the installer. The line pressure is not important, 5 to 30 pounds per square inch being satisfactory. A novel and simple way to supply this pressure automatically

regulated is to connect an inflated automobile inner tube to the coaxial line. A pressure gauge in this range may be purchased for not over a dollar and installed for monitoring line pressure. The line impedance can be matched and balanced to antenna and receiver with coupling coils at both ends of the transmission line. A fixed coil covered with silicone is used on the antenna and the turns on the coil at the receiver are adjusted for optimum impedance matching.

Another phase of the fringe-area, TV-by-the-sea problem is the selection of the antenna itself. Many commercial fringe area antennas are available. These are generally multi-element affairs with stacked arrays or corner reflectors. In many cases the layman will not buy them because of their initially high cost. He goes merrily along experimenting with various combinations of reflectors, V cones, folded dipoles, etc., without considering the impedance of the contraption or its relationship to the transmission line or receiver impedance. Laymen as well as many service technicians have loosely accepted RMA standards for 300-ohm receiver inputs and insist on using this impedance transmission line regardless of how poor it may match the antenna or receiver.

The antenna should have the highest possible impedance to take advantage of the much lower loss of 300-ohm line over 72-ohm line, where flat molded line is used. If coaxial pressurized line is used, the antenna impedance is not critical, as adjustment can be made with coupling coils. Stacked antennas and antennas with corner reflectors, unless they have multifolded dipole radiators, are generally unsatisfactory. The antenna impedance may be only 10 to 20 ohms. If a matching step-up transformer is used on the antenna assembly, it will then be satisfactory. Of course these antennas are better than a single element antenna; but unless the transmission line impedance matches the antenna, the losses may be so great that there is no improvement.

Height above ground of the antenna will affect reception in two ways: it will change the path of the received signal, and it will change the impedance of the antenna. Antenna impedances are calculated and measured on the basis of the antenna being so many quarter or half waves above a true ground plane. Around houses, trees, etc., the height or depth of a ground plane is open to question, and the optimum antenna height may be found only by raising and lowering the antenna. Sometimes a reduction in height of several feet will increase signals tremendously.

When determining the correct height for the antenna or transmission line impedance, it is imperative to use the television receiver on a weak channel so that any improvement can visually be observed. On stronger channels, the a.g.c. in the receiver will hold the picture quality constant over a wide range of input signal.

new! 1951 **ALLIED** catalog

the only complete
up-to-date catalog for
Everything in Radio, Television
and Industrial Electronics

free!

212 value-packed pages



Send for it today!

Here's the only *complete, up-to-date* Buying Guide to TV, Radio and Industrial Electronics—packed with the world's largest selections of quality equipment at lowest, money-saving prices. See the latest in TV; AM and FM receivers; radio-phonos; new Sound Systems and P.A. equipment; High-Fidelity Custom Sound components; recorders and accessories; full selections of newest Amateur receivers and station gear; test instruments; builders' kits; huge listings of parts, tubes, tools, books—the world's *most complete stocks* of quality equipment.

ALLIED gives you *every* buying advantage; speedy delivery, expert personal help, lowest prices, assured satisfaction, liberal time payment terms. Get the latest 1951 ALLIED Catalog. Keep it handy—it will save you time and money. Send for your FREE copy!

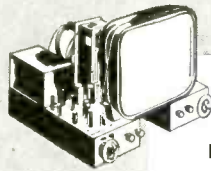

**THE WORLD'S
LARGEST STOCKS**

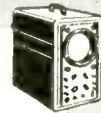

Radio Parts Unlimited
Test Instruments
Television & Home Radios
P.A. and Hi-Fi Equipment
Amateur Station Gear
Supplies for Industry

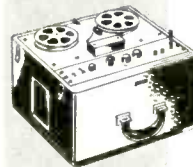
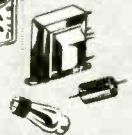

QUICK, EXPERT SERVICE



SEND TODAY FOR RADIO'S
LEADING BUYING GUIDE

ALLIED IS YOUR TELEVISION HEADQUARTERS



To keep up with TV, depend on ALLIED! Count on us for the latest releases and largest stocks of picture tubes, component parts, antennas and accessories—plus the latest in TV tuners and kits. If it's anything in TV—we have it. So remember —for TV—it's ALLIED First!

free



ALLIED RADIO

the World's Largest Radio Supply House

EVERYTHING IN ELECTRONICS

ALLIED RADIO CORP.
833 W. Jackson Blvd., Dept. 2-B-1
Chicago 7, Illinois

Send FREE 212-page 1951 ALLIED Catalog No. 126

Name _____

Address _____

City _____ Zone _____ State _____

Simple Wired Radio Transmitter

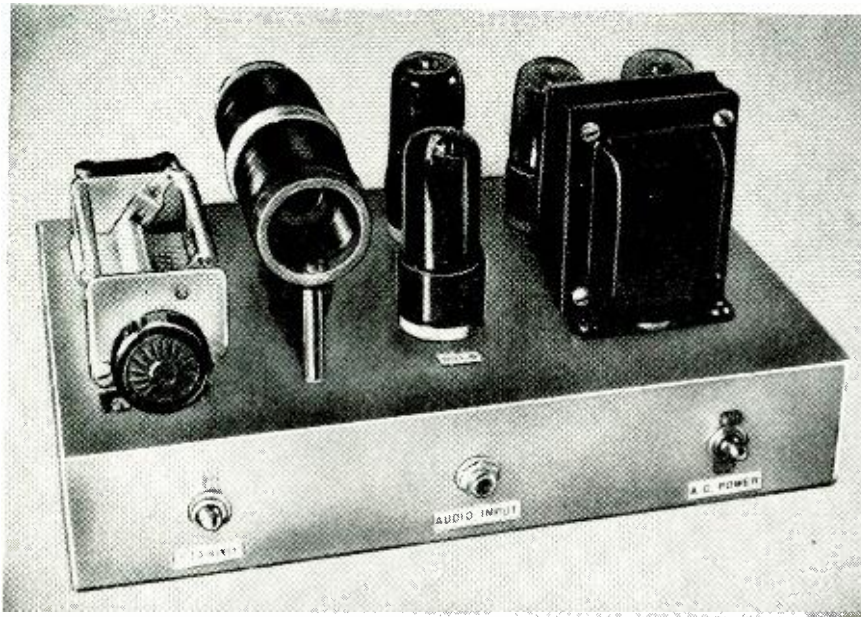

A photo showing the chassis layout of the 4-tube carrier-current transmitter.

The companion unit to the wired radio receiver described in December. These two make a compact little radio outfit

By RUFUS P. TURNER, K6AI

THE wired-radio (carrier-current) transmitter described in this article is a companion unit to the receiver described in the author's previous wired-radio article. This is a small-sized, low-powered transmitter of the simplest design. Mounted side by

side, the receiver and transmitter make a compact wired-radio station for the unlicensed experimenter.

This transmitter consists of a triode-connected 50L6-GT low-frequency r.f. oscillator modulated by a by a tetrode-connected 50L6-GT. Simple Heising modulation is used. Plate and screen power are supplied by a voltage doubler using two 50Y6-GT tubes connected in parallel to furnish high current. The two 50L6-GT heaters are connected in series and then to the a.c. power line, as are also the two 50Y6-GT heaters. No speech amplifier is included on the transmitter chassis, since wired-radio experimenters own microphones of various types, and the required gain will differ for each type. For example, no amplifier at all is needed with a single-button carbon microphone, while a multistage amplifier is required with crystal and dynamic types. An audio input jack on the front of the chassis receives the output of an external speech amplifier or the secondary winding of a microphone transformer.

The complete transmitter, chassis-mounted, is shown in the photo. While open-chassis-type construction is shown here, the transmitter may be housed in any appropriate cabinet, or it can be mounted behind a rack panel.

The transmitter circuit

The complete circuit of the wired-radio transmitter is given in Fig. 1. The

low-frequency r.f. oscillator is a simple Hartley circuit. The carrier frequency is determined by the values of the inductance of coil L1 and the sum of the capacitances of C1 and C2. Actually C1 is the main frequency-determining capacitor, since its value is large compared to C2. The variable capacitor is only a shunt trimmer so the carrier frequency can be shifted over a narrow band. C1 must be a good-grade transmitting-type mica capacitor.

Coil L1 consists of 185 turns of No. 22 enameled wire close-wound on a 1½-inch diameter polystyrene form and tapped 60 turns from its low (grid connection) end. This coil tunes to 100 kc when C1 is approximately 0.007 μf. The frequency table shows the approximate values C1 must have in order to tune the oscillator circuit to the most useful carrier frequencies within the range of the receiver described in the author's previous article.

The coupling coil L2, consists of 10 turns of No. 22 d.c.c. wire close-wound on a protective ring of Scotch tape at the center of L1. Coil L2 is connected with a short length of twisted pair or coaxial cable to the two signal output terminals.

The 50L6-GT class-A modulator is coupled to the oscillator by means of the iron-core 20-henry choke. Old-timers will recognize this as the straight Heising system. The audio input jack is a closed-circuit unit which grounds the

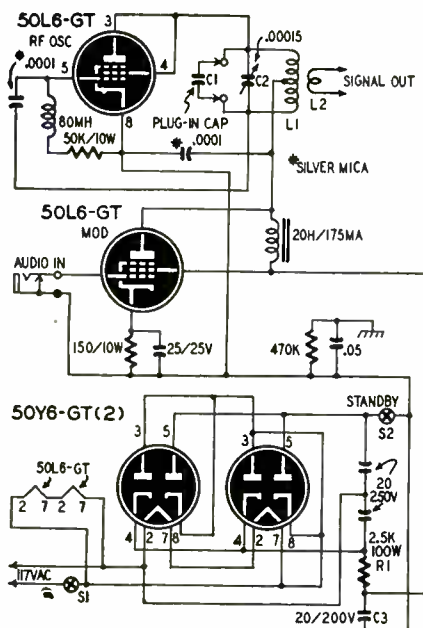

Fig. 1—Schematic of the transmitter. The power supply does not work on d.c.



Quality checks and tests make
RAYTHEON PICTURE TUBES
Right for Sight!

Raytheon Television Picture Tubes must pass 101 rigid tests and inspections before a tube is allowed to be shipped. Every component, every assembly and every tube is precision tested for quality of material, accuracy of dimensions, and electrical performance by skilled workers using the finest checking and control system.

That's why Raytheon picture tubes are Right for Sight — right for you to choose and use for replacements and conversions.

101 basic tests make Raytheon Picture Tubes mechanically and electrically perfect; Raytheon's vast background in the pioneering and manufacture of almost every type of electronic tube keeps them ahead of the field in design and performance. Use Raytheon picture tubes with complete confidence that you are giving your customers the finest quality Picture Tubes money can buy.

See your Raytheon Distributor today.

RAYTHEON

®

Excellence in Electronics

**RAYTHEON
 MANUFACTURING COMPANY**

Receiving Tube Division

Newton, Mass., Chicago, Ill., Atlanta, Ga., Los Angeles, Calif.

RADIO AND TELEVISION RECEIVING TUBES • CATHODE RAY TUBES
 SPECIAL PURPOSE TUBES • SUBMINIATURE TUBES • MICROWAVE TUBES

COPYRIGHT 1951

USE the HANDBOOKS
the EXPERTS use

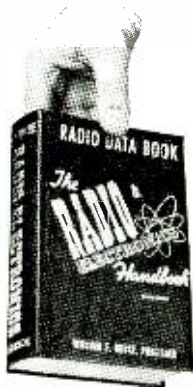

Let The RADIO & ELECTRONICS HANDBOOK

Solve Your Problems

This Handbook assists you in every operation in Radio and Electronics. Gives you the fundamentals, complete ground work, understanding of all types of radio and electronic gear and their circuits, including theory of operation.

Shows you expert methods of planning, building, installing, operating, testing, adjusting and servicing. The know-how of radio and electronics presented in plain language and simple terms with easy to understand drawings and working diagrams.

You get 900 pages of basic knowledge, methods, and data of radio and electronics completely illustrated with over 1500 drawings, and diagrams.

A complete Data Section provides you with handy reference to all radio symbols, codes, tables, standards and laws of radio and electronics.

Written by the Boyce-Roche experts who make electronic manuals for the U. S. Signal Corps. Over 25,000 in use.

Send for yours today.

\$5.95

The VIDEO HANDBOOK

Teaches television and provides complete handbook reference on all phases with full sections on principles of television, receivers, antennas, test equipment, servicing, pattern interpretation, transmitters, show production and more..... \$5.95



SPECIAL OFFER

Save one dollar. Send for the RADIO & TELEVISION LIBRARY SET and get The RADIO & ELECTRONICS HANDBOOK and The VIDEO HANDBOOK in handsome slip case for only \$10.90 (Regularly \$11.90)

10-DAY FREE EXAMINATION COUPON

(Good only while special Library Set offer lasts)

BOYCE-ROCHE BOOK CO.

Caldwell 42, New Jersey

Send Radio & Electronics Handbook @ \$5.95

Video Handbook @ \$5.95

Library Set @ \$10.90

In ten days I will send you price plus postage or I will return book(s) postpaid. (Offer good only in U. S.)

Name

Address

City, Zone, State

Employed By

Save Postage! We pay postage if you enclose full price now. Money back on same return privilege.

grid of the modulator tube when the audio input plug is withdrawn from its socket.

The line-operated power supply is a full-wave voltage doubler. This is not an a.c.-d.c. power supply. In this circuit, two 50Y6-GT tubes are connected in parallel to permit more current to be

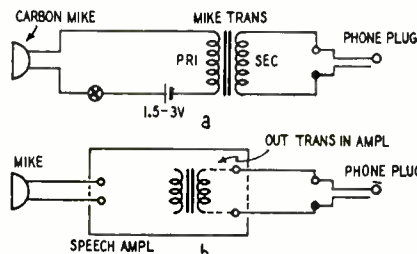

Fig. 2—Input circuits for (a) carbon and (b) crystal or dynamic microphones.

drawn from the doubler. Direct current delivered by the doubler circuit is reasonably smooth, but resistor R1 and capacitor C3 help to clean up plate voltage ripple. The standby switch S2 allows transmitter operation to be interrupted during receiving intervals without turning off the tube heaters. A second s.p.s.t. toggle switch, S1, in series with the power line, shuts down the entire transmitter.

How to build it

The little transmitter is built on a standard 11 x 7 x 2-inch metal chassis. The tuning capacitor C2 is insulated from the chassis. Two insulated feed-through screw-terminal bushings (Johnson type 44) receive the fixed capacitor C1. The rotor and stator terminals of the variable capacitor also are connected to these screw terminals.

The coil is mounted well above the chassis on two studs (see photo). Three grommet-lined chassis holes directly under the coil pass the several coil leads through the chassis for connection to circuit points underneath. All parts except the tubes, tuning capacitors, and modulation choke are mounted under the chassis. The two switches and the audio input jack are mounted on the front lip of the chassis. The signal output terminal strip is mounted on the rear lip of the chassis directly under the rear end of the coil, and the power line cord enters a grommet-lined hole in the rear lip directly behind the 50Y6-GT tubes.

The transmitter wiring is conventional. No special precautions are needed except to keep the tank circuit leads short and rigid.

Fig. 2 shows the two methods of handling audio input to the wired-radio transmitter.

The circuit shown in 2-a is for a single-button carbon microphone. The circuit will be similar, except that the transformer primary will be center-tapped. No external amplifier is needed with the carbon microphone.

The circuit given in Fig. 2-b is for crystal, velocity, and dynamic microphones. The speech amplifier must have enough gain to bring the low microphone voltage up to about 8 volts peak

at the grid of the 50L6-GT modulator. In most cases, a conventional high-gain 6SJ7-6J5 lineup will give all the gain that is needed.

Connection to the line

Fig. 3 shows the connections between the power line and the signal output terminals of the transmitter. The coupling capacitor must be as close as practicable to the electric meter. It will have a capacitance between .01 and 0.1 μ f and should be rated at 600 volts. The best capacitance for a specific installation must be determined by experiment at the transmitter location. Use the value which transmits the strongest signals to a given receiving point. If a 3-phase power line is available, identical coupling capacitors should be connected from the signal output terminal to each "hot" wire of the power line.

It is difficult to predict the communication range of any wired-radio outfit as much depends on conditions at each individual location. Such conditions include the number of distribution transformers between transmitter and receiver, loading on the line at both transmitter and receiver buildings, whether the power line runs through the air or underground, and whether transmitter and receiver are supplied by separate legs of the local power system.

In the larger cities, it is seldom possible to cover more than a few blocks in any direction. In rural areas, on the other hand, all of the power lines are apt to be overhead and transformers less numerous. In such areas, coverage up to 5 or 10 miles often has been

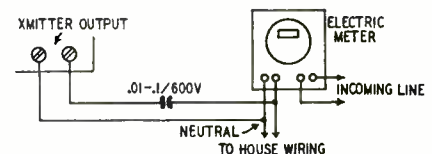

Fig. 3—The hookup for connecting the transmitter output to the power line.

reported by private wired-radio experimenters.

Frequency Table

Carrier freq. (kc)	C1 (with C2 set at mid-scale)
100	.007 μ f
150	.003
200	.002
250	.0015
300	.0008
350	.0005
400	.00037

Materials for Transmitter

Resistors: 1—150, 1—50,000-ohm, 10-watt; 1—2,500-ohm, 100-watt.

Capacitors: 2—100- μ f, silver mica; 1—2,500-volt transmitting type mica (see frequency table); 1—150- μ f midjet variable; 3—20- μ f, 200-volt electrolytic; 1—25- μ f, 25-volt electrolytic.

Miscellaneous: 1—20-h, 175-ma a.f. choke; 1—80-mh r.f. choke; 1—miniature closed circuit jack; 2—s.p.s.t. toggle switches; 1—1/2-inch dia. polystyrene coil form; 2—50L6-GT, 2—50Y6-GT tubes and sockets; hookup wire, chassis, and assorted hardware.

Tuner for Low-Band Antennas

This tuner is for hams who lack the space for elaborate antenna arrays

By JAMES N. WHITAKER, W2BFB

IN THE early days of radio, the amateur put up a wire of whatever length he found convenient and proceeded to load it with coils to get the required electrical length. Today the emphasis is rightly on rotating beams, fixed arrays, and all types of high-gain

in commercial low-frequency installations. The tuner is simply scaled down to meet the frequency and power requirements of amateur service. The tuner is easily adjusted to match any of the commonly used types of transmission line.

A suitable tuner is shown in the photos and the schematic diagram in Fig. 1. This unit was designed to operate in the 3.5- to 4-mc band, but can be scaled up or down to operate in the 1.7-mc or higher-frequency bands.

The coupling and loading inductor L1 was obtained from a war surplus tuner unit of the Navy CAY transmitter designed originally to work on 1.7 mc. The outer form is 2¼ inches in diameter, and the rotor is approximately 1½ inches in diameter. The original Litz winding was removed and both forms rewound with No. 16 double cotton-covered wire. The rotor was close-wound with 16 turns, and the stator with a total of 24 turns spaced the thickness of the wire. Both windings were coated with Bakelite varnish and baked after winding to secure the windings firmly in place.

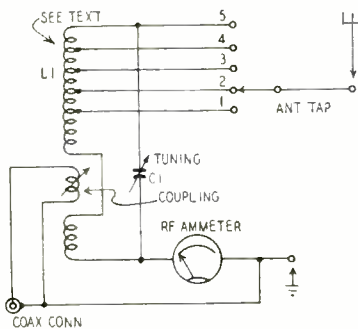

Fig. 1—Schematic of the antenna tuner.

directional antennas. The newcomer with little space for antennas feels that he must forego the pleasures of operating on the lower-frequency bands because he does not have room for a directional antenna for such operation.

Any length of wire can be made to radiate if an arrangement can be devised for feeding the power from the transmitter into the wire. Naturally the nearer the wire is to the proper length, the better the radiation; but the fact still remains that satisfactory results may be obtained even with radiators shorter than 0.1 wavelength.

The entire radiating element should be as far as possible from surrounding objects. This usually requires some sort of a feeder system between the transmitter and the radiator, preferably a coaxial cable. The exception to this rule is where the transmitter is in an attic or out-building where the radiator can have a clear run from the transmitter to its end support.

Radiation inside the building should be reduced as much as possible. The power absorbed by the house wiring, telephone lines, etc., does no good and increases the possibilities of BCI and TVI. It is best to use a length of shielded transmission line such as RG-8/U or similar cable between the transmitter and the antenna tuner to prevent undesirable radiation. Complete shielding of the tuner unit will also decrease undesirable radiation.

The power may be applied to any convenient length of wire by means of a simple antenna tuner, such as is used

the tuning. Once selected, the antenna tap may be fixed permanently in place.

Now disconnect the transmission line from the tuner unit and terminate the tuner with a pure resistance which matches the characteristic impedance of the transmission line. Then observe the transmitter operation under these conditions. Reconnect the transmission line to the tuner unit and adjust the coupling and C1 until the transmitter performance is the same as when the line was terminated in the resistance load. The line is then properly terminated.

The antenna tuner will usually be located in an attic some distance from ground. The ground connection may be made to a counterpoise consisting of one or more lengths of wire strung up in the attic. If a metal cable sheath is handy, run a wire to this also. A water or other pipe or a copper gutter should be added to the system if available. In short, any medium which will increase the capacitance or lower the impedance to ground should be included in the grounding circuit. The object is to get a lower impedance between the ground terminal and earth than appears between the antenna terminal and earth to reduce loss.

The antenna current as indicated by the meter will depend upon the length of antenna used, the over-all resistance of the circuit, and the power applied. The absolute value of current is not important. The meter is primarily a resonance indicator, but when once adjusted, it will indicate any change in power.

This system will not equal a rhombic or other directional antenna array, but it will give satisfactory operation on the lower-frequency bands for those who do not have the space for a more elaborate antenna system.



Front panel photo of the antenna tuner.

The coil could probably be used in its original form for 1.7-mc operation, but the efficiency of a Litz-wound coil is very poor at higher frequencies. The windings must therefore be replaced with solid wire.

Taps are brought out every five turns from the high end of the winding as shown in Fig. 1. The tap switch may be omitted in a permanent installation and the antenna soldered directly to the tap which provides the best operation.

To adjust the tuner unit, feed some power into the coupling coil and vary the capacitor C1 and the antenna tap for maximum reading in the r.f. ammeter. In some cases a small capacitor in series with the antenna may improve

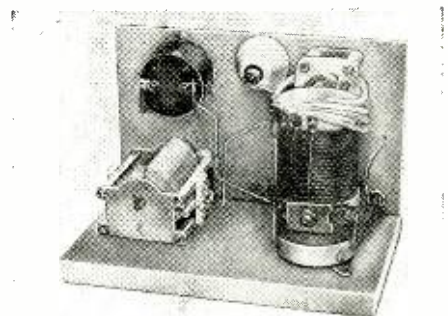

Rear view of the unit showing how the coil is wound and the layout of parts.

STANCOR *High Fidelity* OUTPUT TRANSFORMERS

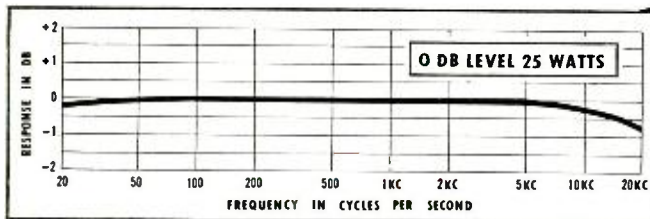

Curve represents an average response of the ten transformers in this series. Units used for this test were drawn at random from current Stancor stock.

±1db FROM 20 TO 20,000 cps

Premium Quality at Low Cost

Stancor has taken advantage of the most advanced design and manufacturing practices to bring you a series of output transformers combining outstanding audio response with very moderate cost.

Extensively interleaved "trifilar" windings, extremely tight coupling, and careful electrical balance result in audio fidelity to please the most critical specialist. An inexpensive, but thoroughly practical, type of mounting is used since elaborate shielding is not required at the audio output power level.

Listed part numbers have a maximum power level rating of 50 watts and provide a wide selection of impedances for popular amplifier applications.

PART NO.	PRI. IMP. (P-P) IN OHMS	SEC. IMP. IN OHMS*	MAX. PRI. D. C. PER HALF	NET PRICE
A-8050	1500	8, 16	200 ma	\$10.86
A-8051	2500	8, 16	150 ma	10.86
A-8052	3000	8, 16	175 ma	10.86
A-8053	5000	8, 16	150 ma	10.86
A-8054	9000	8, 16	100 ma	10.86
A-8060	1500	500	200 ma	10.86
A-8061	2500	500	150 ma	10.86
A-8062	3000	500	175 ma	10.86
A-8063	5000	500	150 ma	10.86
A-8064	9000	500	100 ma	10.86

For complete specifications and prices of more than 450 stock part numbers, including other high fidelity transformers, see the current Stancor catalog. Ask your distributor for a copy or write direct.



STANDARD TRANSFORMER CORPORATION 3592 ELSTON AVENUE, CHICAGO 18, ILLINOIS

WANTED TO BUY

Large and small quantities of new or used electronic government or manufacturers' surplus tubes and equipment. Highest prices paid. State quantity, condition and best price in first letter.

Box No. F-2 c/o Radio-Electronics
25 West Broadway
New York 7, N. Y.

TELEVISION RECEIVER—\$1.00

Complete instructions for building your own television receiver. 16 pages—11"x17" of pictures, pictorial diagrams, clarified schematics. 17"x22" complete schematic diagram & chassis layout. Also booklet of alignment instructions, voltage & resistance tables and troubleshooting hints.—All for \$1.00. Write for free catalogue.

CERTIFIED TELEVISION LABORATORIES
Dept. C, 5507-13th Ave., Brooklyn 19, N. Y.

Every RADIOMAN can use these SERVICE HINTS!

Valuable Manual Yours—FREE
Write today—no obligation.
FEILER ENGINEERING CO. Dept. 2RC1-1
1601 S. Federal St. Chicago 16, Ill.

Every page of "How to Simplify Radio Repairs" is packed with on-the-bench, practical ideas.

NOVEL IMPEDANCE METER

Described through the courtesy of Cornell-Dubilier Electric Corp., this simple dual-range impedance meter is designed for use with an a.f. oscillator, a.c. v.t.v.m., and ohmmeter. This unit does not require a resistor decade or calibrated precision resistor. The diagram shows the hookup of the meter which may be built into a 6 x 5 x 4-inch metal utility box. Heavy busbar is used for the wiring.

Use short leads to connect the unknown impedance to the IMPEDANCE TEST TERMINALS. Connect an a.f. signal generator to the SIGNAL INPUT jack through a shielded cable. Tune the oscillator to 60, 400, or 1,000 cycles and adjust its output to 0.1 volt. Set the a.c. v.t.v.m. to its 1-volt range (or the range on which 1 volt is usually read) and plug it into the V.T.V.M. JACK. Set

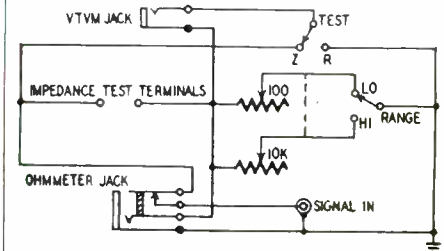

Circuit of the novel impedance meter.

the RANGE switch to LOW and the TEST switch to Z. Note the reading on the meter. Swing the TEST switch rapidly between Z and R and adjust the ganged 100- and 10,000-ohm potentiometers so the voltage reading is the same when the TEST switch is in either position. If the voltages will not balance, throw the RANGE switch to HIGH and increase the signal input to between 1 and 5 volts, and change the voltmeter range accordingly. Adjust the resistance controls so the voltages are equal when the TEST switch is in either position. Leave the resistance control in the position where the two voltages exactly balance.

Remove the v.t.v.m. from its jack, switch it to its ohmmeter range and plug it into the ohmmeter jack. Read the impedance value on the ohmmeter scale. The extra contacts on the OHMMETER JACK open to break the signal input circuit when the ohmmeter is connected.

If a signal generator is not available, test can be made at 60 cycles by using a 2.5-volt filament transformer with a variac or power rheostat in the primary circuit to control the output voltage.

The circuit is simply a convenient method of finding a resistance that is equal to the impedance under test at the frequency used. When the voltage across the resistance is the same as that across the impedance, the resistance is equal to the impedance. This circuit will work equally well whether the impedance is inductive or capacitive.

For best accuracy, the input signal from the generator should be kept as low as possible and still give readings well upscale on the meter.

4 Pages of TEST EQUIPMENT at prices every serviceman can afford!

MONEY BACK?

Every single unit described on this and the following pages is offered on a strict "money-back-if-not-satisfied-basis." No if's—no but's—no maybe's. Simply send your order for any unit

or units you select and try them out for 10 days. If not completely satisfied—return for refund in full. No explanation necessary. You are sole judge.

GUARANTEE?

Every instrument sold by us is covered by a one year guarantee. Guarantee registration card is included with shipment.

KITS?

We have discontinued advertising TEST EQUIPMENT in Kit form. The units offered on these 4 pages are completed instruments, NOT KITS! Every model is factory-wired, calibrated and ready to operate.

TUBE TESTERS

Important Note: The two models described below include slip-on portable hinged covers. This is a very desirable feature in Tube Testers because the multiple switches used on such units indicate properly only when clean. The slip-on covers insure long life because the front panel, including all switches, is fully protected when the instrument is not in actual use.

THE NEW MODEL 247



Check octals, loctals, bantam jr., peanuts, television miniatures, magic eye, hearing aids, thyratrons, the new type H.F. miniatures, etc.

Features:

★ A newly designed element selector switch reduces the possibility of obsolescence to an absolute minimum.

★ When checking Diode, Triode and Pentode sections of multi-purpose tubes, sections can be tested individually. A special isolating circuit allows each section to be tested as if it were in a separate envelope.

★ The Model 247 provides a supersensitive method of checking for shorts and leakages up to 5 Megohms between any and all of the terminals.

★ One of the most important improvements, we believe, is the fact that the 4-position fast-action snap switches are all numbered in exact accordance with the standard R.M.A. numbering system. Thus, if the element terminating in pin No. 7 of a tube is under test, button No. 7 is used for that test.

Model 247 comes complete with new speed-read chart. Comes housed in handsome hand-rubbed oak cabinet sloped for bench use. A slip-on portable hinged cover is indicated for outside use. Size: 10 3/4" x 8 3/4" x 5 3/4".

\$ **29**⁹⁰
NET

SUPERIOR'S NEW MODEL TV-10



Specifications:

★ Tests all tubes including 4, 5, 6, 7, Octal, Lock-in, Peanut, Bantam, Hearing-aid, Thyratron, Miniatures, Sub-Miniatures, Novals, etc. Will also test Pilot Lights.

★ Tests by the well-established emission method for tube quality, directly read on the scale of the meter.

★ Tests for "shorts" and "Leakages" up to 5 Megohms.

★ Uses the new self-cleaning Lever Action Switches for individual element testing. Because all elements are numbered according to pin-number in the RMA base numbering system, the user can instantly identify which element is under test. Tubes having tapped filaments and tubes with filaments terminating in more than one pin

are truly tested with the Model TV-10 as any of the pins may be placed in the neutral position when necessary.

★ The Model TV-10 does not use any combination type sockets. Instead individual sockets are used for each type of tube. Thus it is impossible to damage a tube by inserting it in the wrong socket.

★ Free-moving built-in roll chart provides complete data for all tubes.

★ Newly designed Line Voltage Control compensates for variation of any line voltage between 105 Volts and 130 Volts.

The Model TV-10 operates on 105-130 Volt 60 Cycles A.C. Comes housed in a beautiful hand-rubbed oak cabinet complete with portable cover.

\$ **39**⁵⁰
NET

TO ORDER -- TURN TO PAGE 68 FOR RUSH ORDER FORM

GENERAL ELECTRONIC DISTRIBUTING CO.

DEPT. RC-2, 98 PARK PLACE

NEW YORK 7, N. Y.

Phone REctor 2-1677

1

BUY WITH CONFIDENCE!!

WE KNOW THE PRICE IS UNBELIEVABLY LOW,

but that's not all! In addition, this finely engineered instrument provides a degree of accuracy never before attained in a unit selling for even double this price. Furthermore—in designing this unit, we took advantage of every recent improvement in components. For example, by using slug-tuned coils, we are able to efficiently adjust each instrument for

perfect accuracy. This feature will also enable you to recalibrate the model 200 periodically without having to return it to the factory. The use of a Noval tube (the 12AU7) with its extremely low inter-electrode capacity enabled us to reach a higher frequency range than was heretofore possible in a unit of this type.

THE NEW MODEL 200

AM and FM

SIGNAL GENERATOR

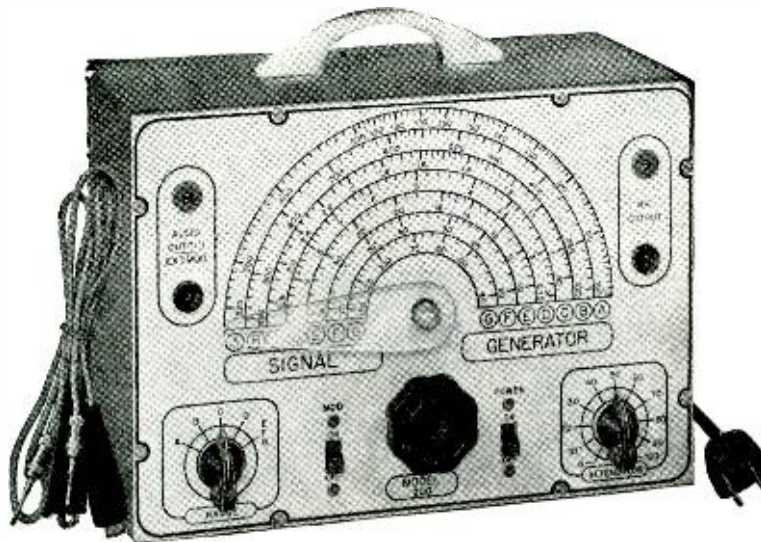

SPECIFICATIONS

- ★ **R.F. FREQUENCY RANGES:** 100 Kilocycles to 150 Megacycles.
- ★ **MODULATING FREQUENCY:** 400 Cycles. May be used for modulating the R. F. signal. Also available separately.
- ★ **ATTENUATION:** The constant impedance attenuator is isolated from the oscillating circuit by the buffer tube. Output impedance of this model is only 100 ohms. This low impedance reduces losses in the output cable.
- ★ **OSCILLATORY CIRCUIT:** Hartley oscillator with cathode follower buffer tube. Frequency stability is assured by modulating the buffer tube.
- ★ **ACCURACY:** Use of high-Q permeability tuned coils adjusted against 1/10th of 1% standards assures an accuracy of 1% on all ranges from 100 Kilocycles to 10 Megacycles and an accuracy of 2% on the higher frequencies.
- ★ **TUBES USED:** 12AU7—One section is used as oscillator and the second is modulated cathode follower. T-2 is used as modulator. 6C4 is used as rectifier.

The Model 200 operates on 110 Volts A.C. Comes complete with output cable and operating instructions.

\$ **21⁸⁵**
NET

2

TO ORDER—TURN TO PAGE 68 FOR RUSH ORDER FORM

GENERAL ELECTRONIC DISTRIBUTING CO.

DEPT. RC-2, 98 PARK PLACE, NEW YORK 7, N. Y.

Phone REctor 2-1677

MONEY BACK GUARANTEE!!



Superior's new model 770

AN ACCURATE POCKET-SIZE VOLT-OHM MILLIAMMETER

(SENSITIVITY—1000 OHMS PER VOLT)

FEATURES: Compact—measures $3\frac{1}{8}'' \times 5\frac{7}{8}'' \times 2\frac{1}{4}''$. Uses latest design 2% accurate 1 Mil. D'Arsonval type meter. Same zero adjustment holds for both resistance ranges. It is not necessary to readjust when switching from one resistance range to another. This is an important time-saving feature never before included in a V.O.M. in this price range. Housed in round-cornered, molded case. Beautiful black etched panel. Depressed letters filled with permanent white, insures long-life even with constant use.

SPECIFICATIONS: 6 A.C. VOLTAGE RANGES: 0—15/30/150/300/1500/3000 VOLTS. 6 D.C. VOLTAGE RANGES: 0—7.5/15/75/150/750/1500 VOLTS. 4 D.C. CURRENT RANGES: 0—1.5/15/150 MA. 0—1.5 AMPS. 2 RESISTANCE RANGES: 0—500 OHMS 0—1 MEGOHM.

The Model 770 comes complete with self-contained batteries, test leads and all operating instructions.

\$14⁹⁰
NET



Superior's new
model 670

SUPER-METER

A COMBINATION VOLT-OHM MILLIAMMETER PLUS CAPACITY REACTANCE
INDUCTANCE AND DECIBEL MEASUREMENTS

SPECIFICATIONS:

D.C. VOLTS: 0 to 7.5/15/75/150/750/1,500/7,500 Volts
A.C. VOLTS: 0 to 15/30/150/300/1,500/3,000 Volts
OUTPUT VOLTS: 0 to 15/30/150/300/1,500/3,000 Volts
D.C. CURRENT: 0 to 1.5/15/150 Ma. 0 to 1.5 Amperes
RESISTANCE: 0 to 500/100,000 Ohms 0 to 10 Megohms
CAPACITY: .001 to .2 Mfd. .1 to 4 Mfd. (Quality test for electrolytics)
REACTANCE: 700 to 27,000 Ohms 13,000 Ohms to 3 Megohms
INDUCTANCE: 1.75 to 70 Henries 35 to 8,000 Henries
DECIBELS: —10 to +18 +10 to +38 +30 to +58

ADDED FEATURE:

The Model 670 includes a special GOOD-BAD scale for checking the quality of electrolytic condensers at a test potential of 150 Volts.

The Model 670 comes housed in a rugged, crackle-finished steel cabinet complete with test leads and operating instructions. Size $5\frac{1}{2}'' \times 7\frac{1}{2}'' \times 3''$.

\$28⁴⁰
NET

Superior's
new model TV-20

**20,000 OHMS PER
VOLT**

MULTI-METER and TELEVISION KILOVOLT METER



The Model TV-20 was designed to provide all the multi-meter measurement requirements of A. M., F. M. and Television. Unlike other recent models, which are actually standard V.O.M.'s converted to test the new Television Voltages, the Model TV-20 is a completely new unit. It provides the sensitivity, ranges and accessories which are needed to service F. M. and Television in addition to A. M. Radio. The High Voltage Probe, for example, with a range of 50,000 volts and designed to withstand 100,000 volts, is an integral part of the instrument with a special compartment for housing it when not in use.

SPECIFICATIONS

- 9 D. C. VOLTAGE RANGES. (at 20,000 ohms per Volt)
 - 0-2.5/10/50/100/250/500/1,000/5,000/50,000 Volts
- 8 A. C. VOLTAGE RANGES: (At 1,000 ohms per Volt)
 - 0-2.5/10/50/100/250/500/1,000/5,000 Volts
- 5 D. C. CURRENT RANGES
 - 0-50 Microamperes
 - 0-5/50/500 Milliampere
 - 0-5 Amperes
- 4 RESISTANCE RANGES:
 - 0-2,000/20,000 ohms
 - 0-2/20 Megohms
- 7 D. B. RANGES: (All D. B. ranges based on Odb = 1 Mv. into a 600 ohm line)
 - 4 to +10 db
 - + 8 to +22 db
 - + 22 to +36 db
 - + 28 to +42 db
 - + 36 to +50 db
 - + 42 to +56 db
 - + 48 to +62 db
- 7 OUTPUT VOLTAGE RANGES:
 - 0 to 2.5/10/50/100/250/500/1,000 Volts

The Model TV-20 operates on self-contained batteries. Comes housed in beautiful hand-rubbed oak cabinet complete with portable cover, Built-In High Voltage Probe, H. F. Probe, Test Leads and all operating instructions. Measures $4\frac{1}{2}'' \times 10\frac{1}{4}'' \times 11\frac{1}{2}''$. Shipping Weight 10 lbs.

ADDED FEATURE:

The Model TV-20 includes an Ultra High Frequency Voltmeter Probe, A Silicon V. H. F. Diode together with a resistance capacity network provides a frequency range up to 1,000 MEGACYCLES. When plugged into the Model TV-20, the V. H. Probe converts the unit into a Negative Peak-Reading H. F. Voltmeter which will measure gain and loss in all circuits including F. M. and T. V.; check capacity and impedance; test efficiency of all oscillator circuits; measure bandwidth of F. M. and T. V.; etc.

\$39⁹⁵
NET

TO ORDER TURN TO PAGE 68 FOR RUSH ORDER FORM

GENERAL ELECTRONIC DISTRIBUTING CO.

98 PARK PLACE DEPT. RC-2 NEW YORK 7, N. Y. Phone—REctor 2-1677

3

**Superior's
model CA-12**

SIGNAL TRACER



THE WELL KNOWN MODEL CA-12 IS THE ONLY SIGNAL TRACER IN THE LOW PRICE RANGE INCLUDING BOTH METER AND SPEAKER!!!

SPECIFICATIONS

- ★ Comparative Intensity of the signal is read directly on the meter—quality of the signal is heard in the speaker.
- ★ Simple to Operate—only one connecting cable—no tuning controls.
- ★ Highly Sensitive—uses an improved vacuum-tube voltmeter circuit.
- ★ Tube and Resistor Capacity Network are built into the detector probe.
- ★ Built-In High Gain Amplifier—Alnico V Speaker.
- ★ Completely Portable—weighs 8 pounds—measures 5 1/2" x 6 1/2" x 9".

Model CA-12 comes complete with all leads and operating instructions.....

**\$2995
NET**

Superior's new model TV-30

TELEVISION SIGNAL GENERATOR

ENABLES ALIGNMENT OF TELEVISION I F. AND FRONT ENDS WITHOUT THE USE OF AN OSCILLOSCOPE!



The Model TV-30 represents a radical departure in the design of Television Signal Generators. Unlike the "sweep" type of Generator which requires the use of an Oscilloscope and extensive technical knowledge including pattern interpretation etc., the TV-30 is a self-contained unit which permits alignment of Television Receivers by the use of exactly the same methods employed in the past to align Broadcast and Short-Wave Receivers.

FEATURES

- Built-in modulator may be used to modulate the R. F. Frequency also to localize the cause of trouble in the audio circuits of T. V. Receivers.
- Double shielding of oscillatory circuit assures stability and reduces radiation to absolute minimum.
- Provision made for external modulation by A. F. or R. F. source to provide frequency modulation.
- All I. F. frequencies and 2 to 13 channel frequencies are calibrated direct in Megacycles on the Vernier dial. Markers for the Video and Audio carriers within their respective channels are also calibrated on the dial.
- Linear calibrations throughout are achieved by the use of a Straight Line Frequency Variable Condenser together with a permeability trimmed coil.
- Stability assured by cathode follower buffer tube and double shielding of component parts.

SPECIFICATIONS

Frequency Range: 4 Bands—No switching; 18-32 Mc., 35-65 Mc., 54-98 Mc., 150-250 Mc.
 Audio Modulating Frequency: 400 cycles (Sine Wave). Attenuator: 4 position, ladder type with constant impedance control for fine adjustment.
 Tubes Used: 6C4 as Cathode follower and modulated buffer. 6C4 as R.F. Oscillator. 6SN7 as Audio Oscillator and power rectifier.
 Model TV-30 comes complete with shielded co-axial lead and all operating instructions. Measures 6" x 7" x 9". Shipping Weight 10 lbs.

**\$2995
NET**

**RUSH
ORDER
FORM**

**CUT
OUT
AND
MAIL
TODAY!**

**GENERAL ELECTRONIC DISTRIBUTING CO.
DEPT. RC-2, 98 PARK PLACE, NEW YORK 7, N. Y.**

Phone: REctor 2-1677

GENTLEMEN:

PLEASE RUSH THE MATERIAL LISTED BELOW:

QUANTITY	MODEL	PRICE

TOTAL

\$..... (Payment in Full Enclosed)

\$..... (Deposit Enclosed—Ship Balance C.O.D.)

SHIP TO:

Name

Address

City Zone State.....



Timer Input Circuit

IN THE February 1950 issue, an unusual timer was described by Mr. E. R. Morton of the Bell Telephone Laboratories for indicating directly in milliseconds. We described only the timing circuit because the input (which initiates and terminates the timed interval) is quite elaborate when used for testing relays. However, Mr. Morton points out that for general timing purposes a simple control circuit ahead of the timer is sufficient. Fig. 1 shows such an input followed by the two-tube timer. Component values shown are those used in the Bell Laboratories setup, but are not extremely critical, and the more easily obtained "preferred values" would no doubt work equally well.

The input control has two switches. It is possible to measure the time interval between operating them in succession or the time either one remains open or closed. The switches may be part of some equipment under test or they may be conductors broken mechanically, as by a falling weight, a bullet or a machine part.

Table I lists the sequences of operation which may be used. In each case one of the switches removes grid bias from the previously blocked V1 to start the timed interval. Then another switch (or the same one) is operated to block the tube again and end the interval. When V1 conducts, it charges C. The charge increases uniformly with time because V1 is a pentode and has a con-

sible to start the timing operation (by opening S2) at the same instant that some external circuit is opened. It is important that S2 be a snap-type switch in this case so that both poles will be operated *simultaneously*.

The control circuit could be used to measure speed, for example that of a bullet. In that case the switches would be merely conductors to be severed. The second sequence in Table I shows that, if we sever S2 and then S1, the timer will measure the elapsed inter-

TABLE I—TIMING SEQUENCES

Interval Begins		Interval Ends		Initial Setting	
open S2	close S2	S1 closed	S2 closed	S1 closed	S2 closed
open S2	open S1	S1 closed	S2 closed	S1 closed	S2 closed
close S1	close S2	S1 open	S2 open	S1 open	S2 open
close S1	open S1	S1 open	S2 open	S1 open	S2 open

val. The speed of a bullet could then be computed from its time of flight between the conductors.

The 500,000-ohm resistor in the grid circuit of V1 limits the grid current when a positive bias is put on V1. Five separate batteries (or power supplies) must be used.

The timing circuit may be checked and calibrated by throwing the CAL switch which substitutes R for C. Using symbols, the voltage across C at any time is $E=IT/C$, where T is the full-scale reading (of any particular range) and E is the corresponding voltage. When the switch is thrown to CAL, an identical value of E appears across R when $R=T/C$. This is proved by writing $E=IR=IT/C$. the voltage needed for full-scale reading on the meter. Assuming correct values of R and C, the timer is calibrated by throwing the switch to CAL and adjusting P (which controls the constant current I) for full scale.

Nominal R and C values are shown in Table II. For any range T (in seconds) the equation is $RC = T$, where R is in megohms and C in microfarads. Since large capacitors are not adjustable, the corresponding resistor must be varied over a small range. The capacitors should be of the mineral-oil type rather than wax impregnated to avoid errors due to "soak." High-grade insulation should be used throughout the test set because the charge remains on the capacitor until a reading is observed or recorded. Leakage will result in error.

TABLE II—R AND C VALUES

R (megs)	C (µf)	Range (Milliseconds)
.02	0.1	2
.02	1.0	20
.05	4.0	200
.05	4.0	2000

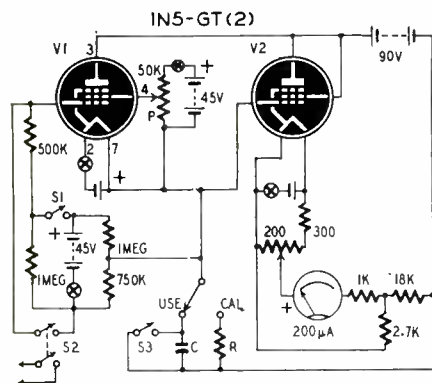

Fig. 1—The timer circuit with input.

stant plate current. The voltage across C is measured by the v.t.v.m. tube V2 whose meter may be calibrated directly in milliseconds. The charge remains on C until S3 shorts the capacitor and prepares the set for another test.

There are only four possible arrangements of the switches. Of these, the only one which permits V1 to conduct is when S1 is closed and S2 open. Under this condition the grid lead returns to the positive terminal of the battery through a resistor. Note in Table I that each of the intervals begins when S1 is closed and S2 is open. S2 is shown as a double-pole switch. This makes it pos-

ALMO **SPOTLIGHT SPECIAL**

TELEVISION PICTURE TUBES

FOR USE IN DUMONT AND GAROD SETS



15 CPH

\$24⁹⁵



12 LPH

\$22⁵⁰

ALMO RADIO CO.
 509 ARCH STREET • Philadelphia
 6205 MARKET STREET • West Phila.
 6th & ORANGE STS. • Wilmington
 4401 VENTNOR AVE. • Atlantic City



EVERY RADIOMAN

Can Use These SERVICE HINTS!

Valuable Manual Yours—FREE!

Every page of "How to Simplify Radio Repairs" is packed with on-the-bench, practical ideas. Contains photos, charts, diagrams—no fluff—no vague theory. In plain every-day language it gives you priceless suggestions—new servicing ideas. You'll use and benefit from the experience of experts. Partial list of contents: How to Localize Trouble; How to Service Amplifiers; How to Test for Distortion; How to Test Audio Circuits; How to Test Speakers; How to Find Faults in Oscillators; How to Test Radio Parts—and it's all yours—FREE! No obligation.



SEND COUPON OR PENNY POSTCARD FOR YOUR FREE COPY TODAY!

FEILER ENGINEERING CO., Dept. 2RC1
 1601 S. Federal St., Chicago 16, Illinois
 Please RUSH my FREE copy of "How to Simplify Radio Repairs."

Name

Address

City..... Zone... State.....

How an Electric Brain Works

Part V—Having learned his arithmetic, Simon is ready to be coordinated by automatic control so that he can learn to follow instructions and find the answer to a problem

By EDMUND C. BERKELEY* and ROBERT A. JENSEN

In previous articles of this series we have shown how an electric brain made of relays can:

1. Store information in registers;
2. Transfer information from one register to another;
3. Add, subtract, multiply, and divide;
4. Convert from decimal to binary notation, and back again.

These operations are the same as those of an automatic relay calculator. However, we have not yet completed the electric brain, for we have not yet arranged for these operations to be carried out in sequence one after another *under automatic control*. This we shall now set out to do.

When an electric brain operates under automatic control, it carries out instructions one after another in some planned sequence. In one important type of electric brain, the instructions are written out on a long piece of tape, in a language the machine can read. The tape may be made of paper punched in a pattern of holes, or of plastic impregnated with magnetic particles, magnetized in a pattern of spots, or of other recorded material. As each section of the tape comes to the input reading device of the machine, the instructions are read by the machine and carried out.

* Author: Giant Brains

For example, we might desire to give to a machine instructions such as these:

1. Take 24.
2. Take 13.
3. Add them.
4. Store this result (result No. 1).
5. Take 45.
6. Take 31.
7. Subtract the latter from the former, and store the result (result No. 2).
8. Compare these results and record 1 if result No. 1 is greater, and 0 if result No. 1 is not greater.
9. Store this result (result No. 3).

When a machine can carry out a set of instructions such as this under automatic control, it is an electric brain. The capacity to store and refer to information (as these instructions imply) and to carry out a chain of operations is the essential capacity of a brain, mechanical, animal or human.

But how do we get a machine to do this?

Commands

In the first article of this series we noted that a mechanical brain was like a telegraph system with many stations, where information could be telegraphed from one station to another. Accordingly, the key to getting a machine to carry out a sequence of instructions is:

1. Organize each instruction in the form of a command involving two

registers or stations (such as Albany and Boston), connect them to the main telegraph line, specify the direction of the message between them (for example, from Albany to Boston), and then transfer the information.

2. Give the computer a long series of successive commands, each of this same standard form.

It is a remarkable fact that almost all numerical and logical handling of information can be reduced to a series of identified commands (i.e., commands that are identified by numbers or labels): "Command No.: Transfer information out of register into register, and then proceed to Command No." This fact becomes easier to see when we remember that some registers are factories, and manufacture new information out of old, and so put out different information from that which went into them.

Yes, yes, you may say, that may all be very true, but up above you put down a series of instruction for an example: now how do you make a machine carry out that series of instructions—how do you convert them into a series of commands of the kind you speak of?

Here is what we do, supposing that we are to give the machine instructions from a tape (see Fig. 1):

1. Transfer information from INPUT station (where the tape is read, and at this time has 24 at the reading point) into COMPUTER REGISTER NO. 1 (the first register in the computer).
2. Transfer information from INPUT station (the tape has moved along, and now has 13 at the reading point for reading by the machine) into COMPUTER REGISTER NO. 2.
3. Transfer information from INPUT station (the tape has again moved along, and now has at the reading point a signal which means addition) into COMPUTER REGISTER 4 (which, we shall suppose, is a special register enabling us to make the computer add or do some other operation).
4. Transfer information from COMPUTER REGISTER NO. 5 (which we shall suppose is the output register of the computer) into STORAGE REGISTER NO. 1.
5. Transfer information from INPUT station (the tape has moved along, and now holds 45) into COMPUTER REGISTER NO. 1.
6. Transfer information from INPUT station (the tape now has 31 at that point ready to be read) into COMPUTER REGISTER NO. 2.

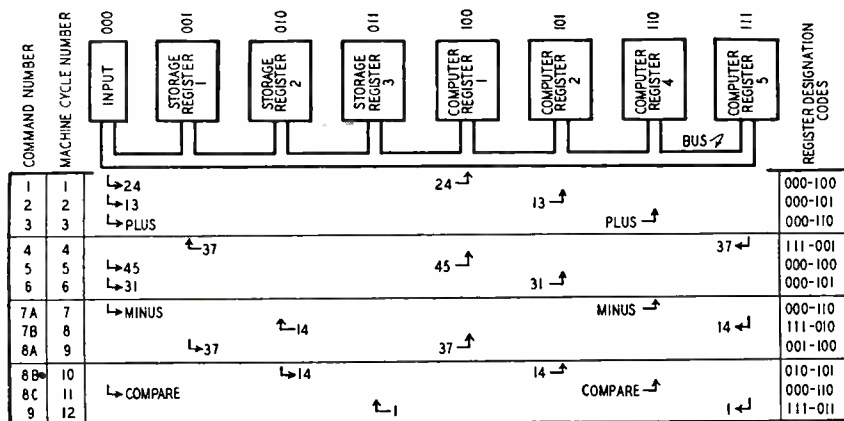

Fig. 1—A diagram showing the flow of information from one register to another in an electric brain in the process of executing a series of commands.

ON LONG ISLAND

817 **EXPERTS****SPECIFY**

PETE CHANKO SAYS:
Chanrose Distributors
Jamaica, N. Y.

Servicemen and Service Dealers are our customers and we carry the products they want. From the very beginning, we have featured N. U. tubes because N. U. pioneered in designing and building tubes to meet the serviceman's strictest requirements. Uniform, reliable, properly designed for interchangeability, N. U. tubes solve every service problem. And, backed by N. U.'s cooperative management, helpful service aids and advertising, N. U. tubes are profit-makers for both us and our 817 customers.

renew
with **N.U.**
premium quality tubes

- RADIO AND TELEVISION RECEIVING TUBES
- VIDEOTRON TELEVISION PICTURE TUBES
- PANEL LAMPS
- TRANSMITTING AND SPECIAL PURPOSE TUBES

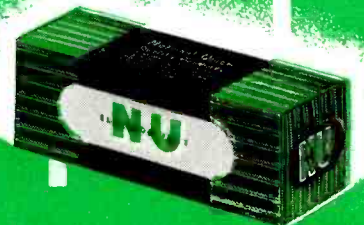

NATIONAL UNION RADIO CORP.

Main Office: 350 Scotland Rd., Orange, N. J.

Research Division: Orange, N. J. • Plants: Newark, N. J. — Hatboro, Pa.

- 7-a. Transfer information from INPUT station (the tape now presents a code or signal that means subtraction) into COMPUTER REGISTER NO. 4 (the operation-accepting register); and
- 7-b. Transfer information from COMPUTER REGISTER NO. 5 (the result register) into STORAGE REGISTER NO. 2 (We see that Instruction No. 7 in the first list breaks into two commands).
- 8-a. Transfer information from STOR-

- AGE REGISTER NO. 1 into COMPUTER REGISTER NO. 1.
- 8-b. Transfer information from STORAGE REGISTER NO. 2 into COMPUTER REGISTER NO. 2.
- 8-c. Transfer information from INPUT station (the tape now presents a signal which when read will mean comparison) to COMPUTER REGISTER NO. 4. (When the computer is called on to compare *a* and *b* we shall suppose it is able to produce 1 if *a* is greater than *b*,

- 0 if *a* is not greater than *b*. We note that Instruction No. 8 breaks up into three commands.)
 - 9. Transfer information from COMPUTER REGISTER NO. 5 (the result register) into STORAGE REGISTER NO. 3.
- Each of these commands will take place during a complete operating cycle of the machine (see the numbers of the machine cycles in Fig. 1). For each cycle, naturally, the machine requires not only the number and operation

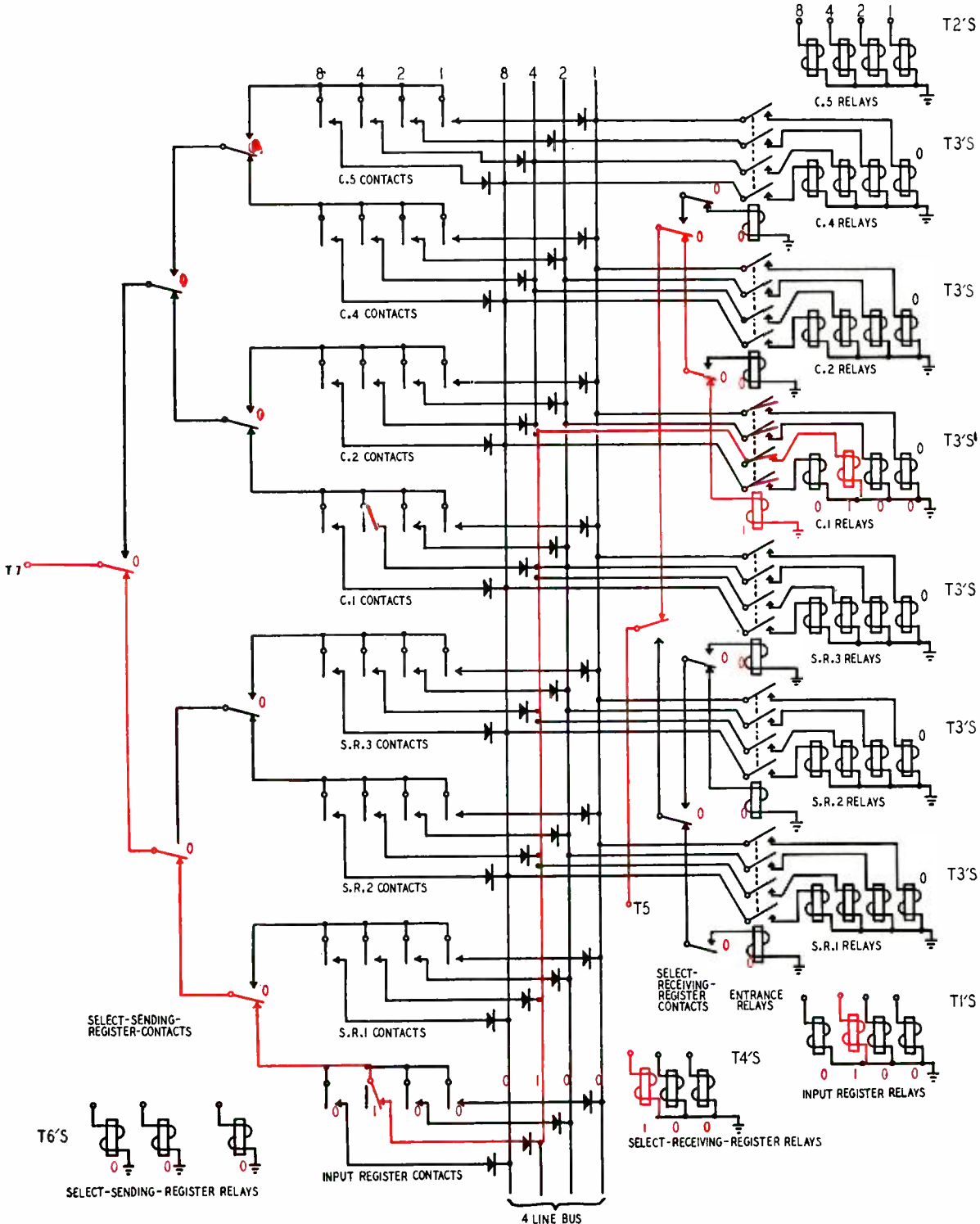

Fig. 2—The main transfer circuit of the electric brain. The 4-line bus is sufficient for transferring one decimal digit coded into binary notation. The circuits shown in red carry current during the first step of the problem.

information from the input station, but also knowledge of the designated registers. So at each cycle we must also give the machine the signals that call for the designated two registers at each cycle. Computer register No. 3 is omitted from this diagram because we do not need it for this problem, but we shall have occasion to use it later for other problems.

So, for our particular series of commands, we shall suppose that the codes of the registers are 000 to 111 as shown right above them in Fig. 1, and that these codes are also given to the machine, cycle by cycle. The machine is constructed to know that the first code refers to the sending register, and that the second code designates the receiving register.

What information then will be on the tape, cycle by cycle? The tape will contain the following information:

Cycle	Information
1	24-000-100
2	13-000-101
3	PLUS-000-110
4	—111-001
5	45-000-100
6	31-000-101
7	MINUS-000-110
8	—111-010
9	—001-100
10	—010-101
11	COMPARE-000-110
12	—111-011

Of course, just as the registers are represented by codes such as 000 or 100, so the numbers like 24 and 13 and the operations PLUS, MINUS, COMPARE will be represented by codes. Certainly, the machine will not be required to translate a collection of alphabetical letters into an operation indication. Probably, all of these numbers and operations will be translated into sets of 1's and 0's corresponding to equipment that has two different stable conditions.

Circuits

Fig. 1 is a schematic diagram of the flow of a problem through an electric brain. But what is the diagram of the actual circuits?

In Fig. 2 is shown the main transfer circuit for the electric brain of Fig. 1. By looking at Fig. 2, we can see most, though not all, of the essential electrical network for making the events of Fig. 1 happen.

Down the center is a four-line bus; this is sufficient for transferring one decimal digit coded into binary notation. The second decimal digit could be provided for by another four lines of bus, but these have been omitted for the sake of simplicity.

On the right side of Fig. 2 are the eight sets of relays which correspond to the eight registers of Fig. 1. We note that we cannot read in from the bus to either the INPUT REGISTER or the COMPUTER 5 REGISTER. This is as it should be, because COMPUTER 5 REGISTER is filled from the information in COMPUTER REGISTERS 1, 2, and 4 and the INPUT REGISTER is filled from the tape. The sets of terminals marked T1's,

this makes TV alignment simple
from **End to End**



the **NEW** Jackson Model TVG-2

Service men the world over buy Jackson instruments for accuracy and simplicity of operation And why not? Just look at the features incorporated in this new '51 model Television Generator:

- Continuously variable sweep frequencies over all TV and FM bands
- Reversible single response pattern with base line or double pattern
- Adjustable sweep width from 100 KC thru 18 MC
- Marker Calibrator continuously variable from 100 KC thru 216 MC
- Separate Crystal Oscillator for use either as a marker or calibrator
- Video Modulation Jack provides for picture or pattern modulation
- Marker Calibrator IF frequencies all on highly stable fundamentals
- Multiple shielding of attenuators and circuits insures low leakage
- Complete Sweep and Marker Generators in one beautiful instrument
- Styled to match the famous Jackson Model CRO-2 Oscilloscope

Truly another "Service Engineered" electronic instrument.

Ask your Jackson Distributor or write for free bulletin.

JACKSON

Electrical Instrument Co. Dayton 2, Ohio

In Canada: The Canadian Marconi Co.

memory of the computer. This often becomes possible when we go to electronic computers with 1,000 or more registers in the *rapid memory*, where the rapid memory is the part of the storage registers of the machine and any specified piece of information can be gotten at very quickly. This is in contrast to the *slow memory*, where many seconds or some minutes may be needed to get at a specified piece of information. For example, we can store dozens of useful common routines, such as a procedure for getting square root, in the rapid memory of the machine, and then tell the machine to pick up any one of them and use that procedure when a given indication in the problem occurs. This has been done with the Model 6 relay computer in Bell Telephone Laboratories in Murray Hill, N. J., which is a particularly well-educated electric brain; it has routines and subroutines which are numbered in the hundreds; they belong to half a dozen levels of "intelligence," and can call for each other.

EXPANDED SCALE METER

Designed especially for testing storage batteries, this meter has a range limited to a minimum of 5 and a maximum of 6 volts. Voltages below 5 cause no deflection. The unit is described in patent 2,509,486, issued to C. W. Danzell.

The heart of the circuit is the non-linear bridge shown. This contains two ganged arms R of equal resistance and two identical low-voltage lamps L. The lamps have nearly zero resistance when

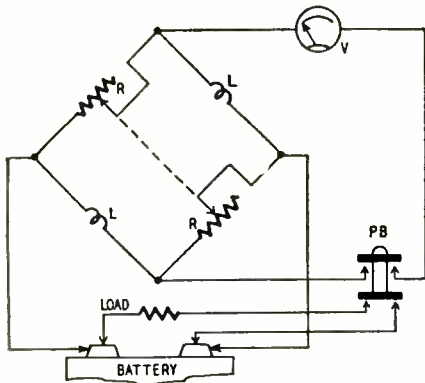

cold. This resistance rises rapidly with filament temperature. R is chosen to equal the resistance of L when the bridge input is 5 volts. Since this balances the bridge, there can be no deflection at that value. Full-scale meter reading occurs at 6 volts.

The meter needle moves backward when the bridge voltage is less than 5. This reverse reading is suppressed as follows: first, all connections are made to the battery under test. Then the push-button is depressed. The lower pole connects a load resistor. An instant later the upper pole closes the meter circuit. By the time the meter is in the circuit the lamps are warm. When the button is released, the meter circuit is interrupted at once. Therefore the reverse deflection is not observed during test.

TRAIN for TELEVISION

FOR BETTER JOBS... FOR BETTER PAY

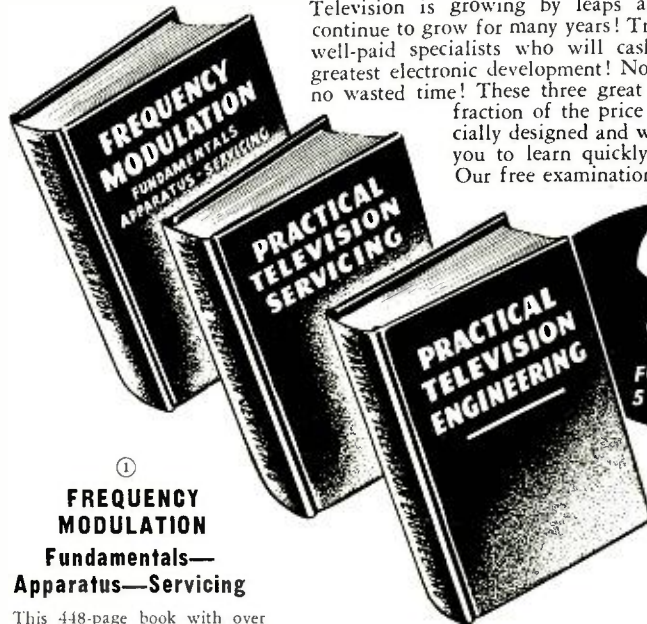

ONLY \$15.50
FOR ALL 3 BOOKS
5 MONTHS TO PAY

5 Months to Pay!

Learn at home... Learn fast... Learn right with the RINEHART TV LIBRARY

These 3 great books offer you a really outstanding, AMAZINGLY LOW-PRICED OPPORTUNITY to get ahead in the greatest, fastest-growing electronics field of all—TELEVISION!

Presupposing a knowledge of basic radio, FREQUENCY MODULATION (Book No. 1) provides up-to-the-minute training in the circuit system that has made modern television possible. PRACTICAL TELEVISION SERVICING (Book No. 2) trains you to install and service television receivers. Each part of the work is clearly explained step by step. Book No. 3 (PRACTICAL TELEVISION ENGINEERING) offers invaluable advanced training in the form of an intensely practical background in the engineering, design and broadcasting end of the business.

Read singly, each book is an authentic, easy-to-understand guide to an essential phase of modern TV. Add all 3 together and you have a specialized training that can help fit you for a good job, better pay or even a business of your own in this vast industry!

SAVE \$1—PAY AS YOU LEARN

Use the attached mail order coupon. Read any or all of these outstanding books for 10 days AT OUR RISK! Buy them singly if you like. Better yet, why not save \$1 by ordering the complete set of 3? The regular price of the 3 books is \$16.50. On our special Rinehart TV Library offer you get them for only \$15.50—with 5 months to pay. Our 10-day free examination offer protects you fully. YOU CAN'T LOSE! Use coupon today!

10-DAY FREE EXAMINATION

Dept. RE-21, RINEHART BOOKS, INC., Technical Division
232 Madison Avenue, New York 16, N. Y.

TO ORDER BOOKS SINGLY
Send me the following books on your 10-day FREE EXAMINATION OFFER. In 10 days, I will either send you the price indicated for each book or return the books to you postpaid.
 FREQUENCY MODULATION PRACTICAL TELEVISION SERVICING
\$5 (\$5.50 outside U.S.A.) \$4 (\$4.50 outside U.S.A.)
 PRACTICAL TELEVISION ENGINEERING
\$7.50 (\$8.00 outside U.S.A.)

SAVE \$1... ORDER THE COMPLETE SET!
Send me Rinehart's TV Library—all three of the above books—on your 10-day FREE EXAMINATION OFFER. If the books are not what I want, I will return them postpaid in 10 days. If I decide to keep them, I will send you \$3.50 as my first instalment and will also send you \$3 a month for the next four months until the special Price of \$15.50 is paid.

Name
Address
City, Zone, State
Your Employer's Name & Address

1
FREQUENCY MODULATION
Fundamentals—
Apparatus—Servicing

This 448-page book with over 300 illustrations covers the entire field of Frequency Modulation—the system on which modern Television as well as many other important developments are based. Basic FM theory, circuits, transmitters, receivers and mobile FM are clearly explained. Other subjects include FM circuit peculiarities; tuning indicators; antennas; test units; alignment; general servicing procedure, etc. Price \$5.00 separately.

2
PRACTICAL TELEVISION SERVICING

Here is a 334-page complete guide to installing and repairing television receivers. Includes dozens of case histories, full explanations of wiring, repair and component replacement techniques; antennas, testing tips, improving picture linearity, fringe area reception and other vital TV service data. Tells what to do—how to do it. Price \$1.00 separately.

3
PRACTICAL TELEVISION ENGINEERING

This 700-page book with its 385 illustrations can help pave your way to a good-paying job in TV manufacturing, laboratory or broadcast studio work! Starting with picture transmission fundamentals, it guides you through all phases of TV equipment and station engineering. Helpful data includes a full explanation of the cathode ray tube; TV camera chains; telecasting techniques; studio problems; lenses; lighting; oscilloscopes; camera tubes; synchronizing generators; video amplifiers; regulated power supplies and dozens of others. Price \$7.50 separately.

Circuit Adds Vectors

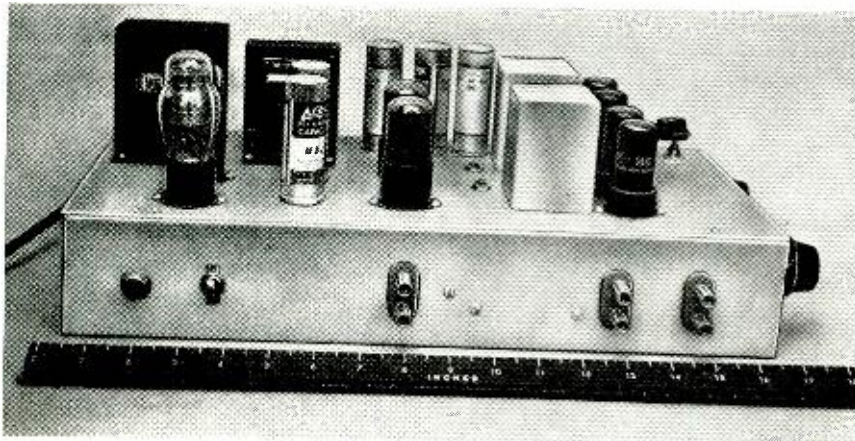

A laboratory model of the vector adder. It serves as part of an analog computer.

Adding vectors with vacuum tubes speeds solving of problems

By L. D. Hindall
and
J. F. Donan*

THE analog computer is a type of electronic calculator. Instead of using digits (like the familiar 1 and 0, as described in the "Simon" series now running in this magazine) it represents mathematical quantities with electrical signals. Since nearly all types of physics problems in such fields as mechanics, acoustics, thermodynamics, as well as electrical problems themselves, can be represented by electrical analogies, the analog computer is extremely useful for solving such problems:

Analog computers are often used to solve problems of the common type which involve rectangular coordinates. The usual way to solve such a problem is to resolve it into horizontal and vertical components, handle these separately, then add the components vectorially to get the resultant solution. Thus one of the many things an analog computer must be able to do is add vectors.

It is easy to represent the magnitude and direction of a vector quantity by the amplitude and phase relation of an electric voltage. The circuits of an analog computer can combine the component solutions of a problem into the resultant solution by adding two electrical signals vectorially to give a resultant voltage that corresponds

to the predetermined rectilinear coordinates.

The block diagram, Fig. 1, describes such a scheme. The component inputs, E1 and E2, are applied to two linear modulators which are correlated by a phase control. The out-of-phase voltages are vectorially added by a mixer circuit and then amplified adequately before detection. Fig. 2 shows the schematic diagram.

The phase control is a standard R-C, as used in thyatron circuits. The vector diagram of Fig. 3 shows how two sine voltages, e1 and e2, of equal ampli-

tude, are controlled over a range of nearly 180° by a variable resistance. The predetermined phase is set by means of a Lissajous figure. These voltages are fed to the control grids of remote cutoff pentodes which perform the linear modulation.

IR and IXc in Fig. 3 are the voltage drops across the resistor and capacitor. Note that e1 and e2, the two equal voltages, are with respect to ground and are not taken directly across the resistor and capacitor.

Each modulator circuit consists of two tubes and uses their variable-mu

* Research engineers, Northrop Aircraft, Inc., Hawthorne, Calif.

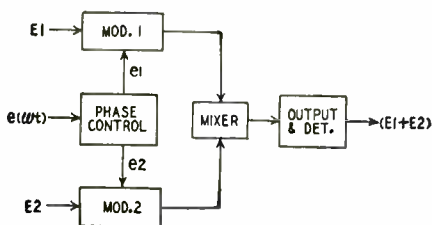

Fig. 1—A block diagram of the vector adder to show its operating principles.

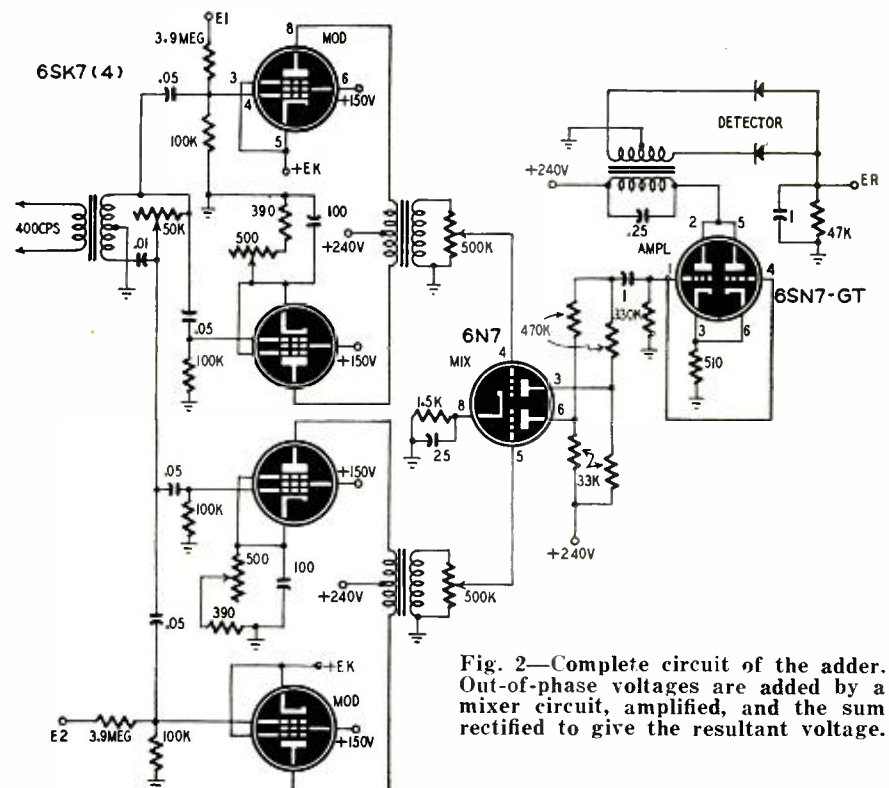

Fig. 2—Complete circuit of the adder. Out-of-phase voltages are added by a mixer circuit, amplified, and the sum rectified to give the resultant voltage.

WHY

See **WHY Rider Manuals are BEST BY TEST.** See **WHY** they are most economical in the long run. See **WHY** they are most popular with competent servicemen.

RIDER TV MANUALS

➔ Offer you the very same information which the service department of the original receiver manufacturer uses. There is no greater **accuracy, authenticity, completeness of detail.** NOBODY, but RIDER, can make this statement!

➔ Include understandable descriptions of the circuit action. In the five RIDER TV MANUALS there are **731 pages of such extremely valuable instructional information**—telling you **HOW** the circuit functions. NOBODY, but RIDER, furnishes so much of this kind of data . . . all of it necessary for successful and profitable TV servicing!

➔ Presents you with no less than **293 pages of signal waveforms**—so vital to rapid trouble diagnosis in picture i.f., sound i.f., video, sweep and sync circuits. NOBODY, but RIDER, offers you anywhere near this amount of absolutely indispensable information!

➔ Incorporate fully **337 pages of official, accurate unpacking and installation data.** NOBODY, but RIDER, brings you as many of these helpful, time-saving instructions!

➔ Give you the **most complete coverage of the manufacturers' receiver output**—not just pilot models—but **ALL** production runs with **ALL** of the changes. NOBODY, but RIDER, puts all of the data . . . so thoroughly, so completely . . . at your fingertips!

Prove, To Yourself, That Rider Manuals

ARE BEST

COMPARE!

Check the completeness of RIDER MANUALS. The five RIDER TV MANUALS contain 10,544 pages. Compare them with any other service. Compare not only listings of model numbers, but all of the information contained which is of value in servicing a receiver. RIDER AM-FM MANUALS contain 31,382 pages. The PA MANUAL contains 2,024 pages.

John F. Rider Publisher, Inc.
480 Canal Street New York 13, N. Y.

Complete your Rider Manual Library! If any volumes are missing, order a replacement today!

properties. This is done by operating the tubes in the midpoint of the square-law region of their transfer characteristics. If the bias of the tube is then varied about this point, the amplification will increase or decrease linearly with this bias. If two tubes are placed in a push-push circuit and set at a null, the increase of the bias of one will give a linear increase of the output, while a decrease will give a corresponding increase with the signal being 180° out of phase, since the output is the differential of two signals. E1 or E2 will determine the variable bias of one tube of the modulator while the null point is set by adjusting the cathode resistor of the other.

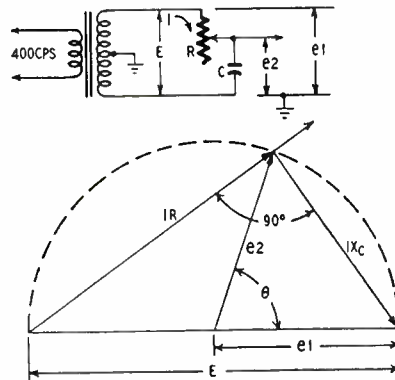

Fig. 3—A vector diagram to illustrate how the phase shift network operates.

Potentiometer voltage dividers are placed across the secondary of the push-push transformers to adjust the output voltage so that both modulators have the same constant of linearity. This constant is defined as the ratio of change of output voltage of the modulator for a corresponding change of E1 or E2. Since there is no guarantee of uniformity of tube characteristics, the modulator output voltages may differ. The input sine wave must be of small amplitude to utilize the linear change of slope of the square-law characteristic. These voltage dividers also set the output voltage of the over-all circuit, the sine wave being of constant amplitude.

The vectorial addition is performed by a simple mixer circuit. This mixed signal is then amplified and passed through a center-tapped transformer. The output voltage ER is obtained by full-wave rectification of the transformer voltage, the rectifier employing crystal diodes, and an R-C load.

The circuit, as used, consisted of 6SK7's in the modulator circuit, a 6N7 mixer, and a 6SN7-GT output amplifier. The fixed cathode potential EK of the varying bias 6SK7's was set at +7.5 volts, and the voltage divider for E1 and E2 was set to give about ±1 volt change of bias. The sine wave was set at 0.1 volt peak-to-peak (400 c.p.s.) at the 6SK7 grids. The maximum possible rate of change of E1 and E2, which vary over a range of -50 to +50 volts is assumed to be 40 c.p.s. This exceeds the 5 c.p.s. limitation of E1 and E2 as used.

Beat the Tube Shortage!

This Sensational New RIDER Book Shows You HOW to Do It!

RECEIVING TUBE SUBSTITUTION GUIDE BOOK

by H. A. Middleton

For AM-FM-TV Receivers and Allied Equipment!



URGENT! Receiving tubes are very scarce . . . and will get scarcer. There is a wide scramble for every type of tube, and you can't always get what you need. What can you do when you can't find a tube replacement? How can you get a set working again? How can you substitute one tube for another?

HERE!

HERE Are The Answers To All Tube Problems!

- 2500 Radio And TV Tube Substitutions Are Listed!
- TV Receiver Filament Wiring!
- Heater Substitution Wiring Instructions!
- Tube Types Classified By Functions!
- And A Wealth Of Other Priceless Data!

Here the serviceman will find 2500 radio and TV tube types systematically listed in numerical sequence with accompanying wiring instructions for making the substitutions. There are views of original and substitute tube sockets, and clear explanations for whatever changes may be necessary. In this, one of the most important servicing books ever published, and certainly a most timely one right now, the serviceman will find the way to turn out jobs that would otherwise remain on the shelf because of lack of proper tubes.

EXTRA! EXTRA! In addition to tube information . . . this sensational book contains material on Cathode-Ray Tube Characteristics, Complete Tube Characteristics Chart, Ballast Tube Data, Pilot Light Information, Resistors—Capacitors—Transformer Color Codes, Transformer Substitution, Fixed Condenser Substitution, and Converting Farm Radio for Electrified Operation.

208 Pages in Heavy Durable Paper Cover. 8 1/2 x 11 inches. Only **\$2.40**

10 DAY MONEY BACK GUARANTEE
Make this book **PROVE** its value!
Unless you agree that it is the best investment you've ever made—return it, and we will refund your money.

Rush This Coupon Today

JOHN F. RIDER PUBLISHER, INC.
480 Canal Street, New York 13, N. Y.

Please send me _____ copies of "RECEIVING TUBE SUBSTITUTION GUIDE BOOK" at \$2.40 per copy. I am enclosing check money-order in the amount of \$_____. If, within 10 days, I am not satisfied—I will return the book(s) in good condition, for refund.

Name _____

Address _____

City _____ Zone _____ State _____

GATED BEAM CIRCUITS

The 6BN6's unusual structure makes it useful for many special circuits

By EDWIN BOHR

EVERYONE in radio work knows that the plate current of a conventional vacuum tube rises in a smooth curve as the negative grid bias approaches zero. A typical curve of this type is shown in Figure 1. This curve is for the 7C7 and is fairly representative.

A new and radically different tube has been developed that uses electron optics and special internal structures to give much a steeper characteristic curve. This tube, known as the 6BN6 gated beam tube, is now available commercially. A curve for the 6BN6 is shown in Figure 2. A signal of only a little more than 1 volt swings the plate current from cutoff to saturation. Even driving the control grid positive will not increase the plate current.

What is the advantage of this? These special characteristics make possible a one-tube limiter-discriminator, a simple square-wave generator, and pulse-height discriminator—just to mention a few possible uses. The tube lowers component costs. Already it is being used as the FM detector in intercarrier sound circuits.

The Tube Structure

Internal structure of the tube is illustrated in Fig. 3. Electrons emitted from the cathode are formed and shaped into a rectangular beam as they pass from the cathode housing into the accelerator structure. Electrons arrive at the first control grid "head on." If the grid is negative, the electrons near the grid are retarded and form a space charge in front of it. This space charge or cloud of electrons repels more electrons from the grid. This is one of

the reasons for the sharp control characteristic. Another reason is that the electrons that cannot pass the negative grid are not returned to the cathode to inhibit further emission and lower the cathode current. Instead they are deflected toward the accelerator where they are collected. When the plate current drops, the accelerator current rises. Possibly this action could be used in a new phase-inverter circuit.

Those electrons passing through the first control grid on the positive signal swing go through a second beam-forming arrangement and meet the second control grid located in the shield structure with the anode. This second control grid is often called the *quadrature grid*. Its control characteristics are much the same as those for the first control grid.

Thus in effect we have two gates or control grids. Before plate current can flow, both gates must be open or partially open at the same time.

Circuits for the tube

One use for this tube is as an FM limiter. A practical circuit appears in Fig. 4. There are no time constants and limiting is instantaneous—just the thing for reducing ignition interference. Limiting occurs when the signal voltage swings past the top and bottom bends in the curve of Fig. 2.

Placing a resonant circuit in the second control-grid circuit makes a combined limiter and discriminator. (See Fig. 5.)

Once during each r.f. cycle the first grid "gates" or lets electrons pass through to the plate. The electrons that pass through represent an electro-

static charge. When they approach the second control grid, they repel the free electrons in the second grid circuit, causing an electron flow to ground.

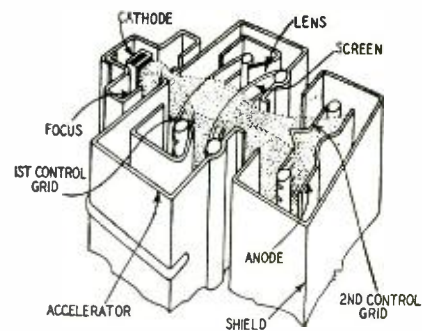

Fig. 3—Internal structure of the 6BN6.

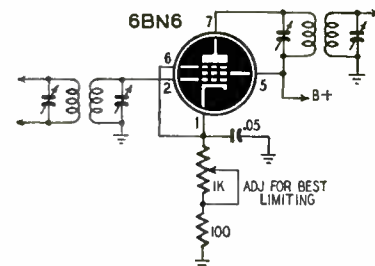

Fig. 4—Limiter circuit using the 6BN6. Pin No. 1 is for cathode, focus electrode, and internal shields, pin 2 is No. 1 grid (signal or limiter), pin 5 is grid No. 2 or accelerator, and pin 6 is for grid no. 3—the quadrature grid.

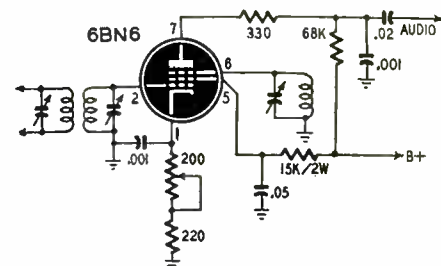
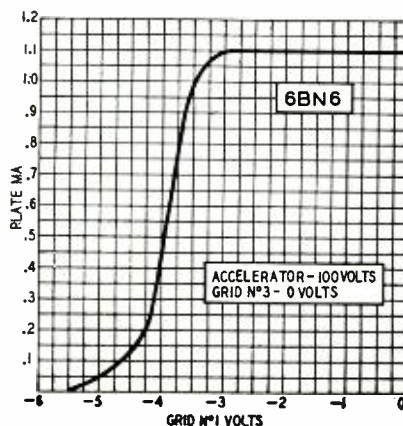
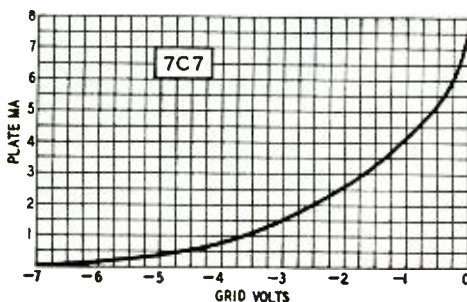

Fig. 5—A combined limiter-discriminator circuit using the gated beam tube.

Fig. 1, below—Transfer characteristic of a 7C7 with the usual sloped curve.

Fig. 2 right—Characteristic of the 6BN6. Plate current goes from cutoff to saturation with 1-volt grid signal.



Since this happens once each cycle, a circuit tuned to the incoming frequency will oscillate. But, the oscillations in the tuned circuit will take place a little later than those in the input circuit. They lag the input signal by 90° or a quarter-cycle. Both gates are open together for only a fraction of a cycle, as shown in Fig. 6-a. If the carrier frequency is lowered, the time of opening of the first gate is retarded, the gates

are open together for a longer time, and the plate current increases. This is shown in Fig. 6-b.

If the frequency of the carrier is raised, the first gate opening time is advanced and the two gates are open together for a shorter time as illustrated in Fig. 6-c, and plate current falls. Thus frequency changes cause

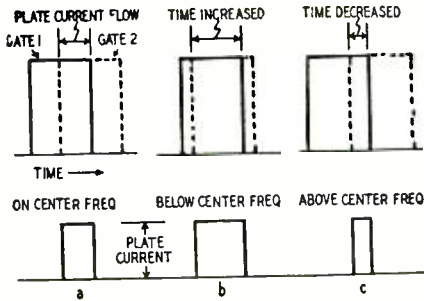

Fig. 6—Diagram showing how the time delay between the two grids gives a discriminator action for FM signals.

plate current changes, and we have a frequency-modulation detector. In the case of TV intercarrier sound, the audio output from the circuit of Fig. 5 is enough to drive the beam power tube without other audio amplification.

Alignment is very simple: the second control-grid tuned circuit is tuned for maximum audio output with input at the correct intermediate frequency. This detector does not give the two familiar tuning spots on each side of proper tuning.

Besides the circuits suggested and described, the resourceful experimenter should find many interesting uses for this tube in test equipment, control devices, and other circuits.

WTVJ CRANE

No tall buildings or hills were available to locate the microwave antenna for a 9-mile remote broadcast at WTVJ in Miami, Fla. Clever technicians put the dish near the top of the 100-foot crane hoist as shown in the photo and the broadcast went off as scheduled.



**YOU'RE FIRST IN LINE!
FOR TOP VALUES IN TV, RADIO & ELECTRONICS**

Be the first to know of the Latest and Best Buys in TV, Radio and Electronic Equipment... Get on Concord's Mailing List. Be sure you get the new Buyer's Guide... issued periodically and packed with the latest available merchandise. This way, when merchandise is available to us... it goes straight to you. Order yours Now.

PUT YOUR NAME ON CONCORD'S MAILING LIST

NOW!

Bargains... Values... Savings. Now you're assured of getting the latest scoops on Radio, TV, and Electronic Equipment First-hand. Send today for your Concord Buying Guide. Just fill in the coupon at the right. Send all orders to Concord - Chicago.

CONCORD RADIO CORP., Dept. JB-51
901 West Jackson Blvd., Chicago 7, Illinois

Please forward your latest Buyer's Guide

Name.....

Address.....

City..... Zone... State.....

OUTSTANDING CONCORD BUYS

MOBILE HIGH VOLTAGE PWR. UNIT



For mobile radios, amateur equipment, PA amplifiers, and many other types of equipment. Well built, made of the finest materials available to meet strict specifications. Especially adapted to furnish plate supply for above mentioned units. Input 12 volts at 10 amps. Output consists of two volt ranges. (1) 275 volts at 10 ma., 12 volts @ 3 amps. (2) 500 volts at 50 ma. Contains two nationally known permanent magnet dynamotors, complete with all hash filters. Each high voltage range is individually fused and the input has an "on and off" switch and an indicating pilot light assembly. Olive drab wrinkle finish. Size: 8-3/8" x 6-1/4" x 11-5/8".
99-9513R - Shpg wt. 27 lbs. **9.95**

PERMANENT MAGNET DYNAMOTOR

Input 12/24 volts @ 8/4 amps., output 12/275 volts @ 3/.110 amps.
99-9589R - Shpg wt. 10 lbs. \$4.95

CAL 88 HIGH-SPEED SOLDERING GUN



New Cal-88 Soldering Gun heats in about 5 seconds! Choice of two heats from same trigger: 100 watts or 150 watts. Built-in light shines directly on your work. New single pole electrode lets you work faster in narrow spots. You can see what you are doing. Beryllium copper electrode requires no tinning. Can be replaced in two seconds. Long duty cycle--heats up in about 5 seconds and can be kept on for about 10 minutes. Its off duty cycle is only 5 minutes. Light in weight... only 1-1/2 lbs! This, plus non-tiring pistol grip and perfect balancing make this the easiest-to-use soldering gun yet. Built-in 1.5 amp fuse protects the transformer. All parts of gun are replaceable.
18-14864R--Shpg. wt. 2 lbs. **14.65**

**RECORDING TAPE
AT TERRIFIC PRICE REDUCTION**



Best Recording Tape Buy on the market! Made by a famous national manufacturer to Concord's strict specifications. 1200' long, 1/4" wide with uniform coating of red oxide particles on kraft paper base. Magnetic coating wound facing in. Plastic reel included. Order while our supply lasts.
35-16297R - 1200' Kraft Paper Base Tape..... **1.49**
As above but on stronger more efficient plastic base for more uniform output and lower noise level.
33-16296R - 1200' Plastic Base Tape... .. \$2.25

CONCORD RADIO

EXPORT Service

Mail Order Center and Showroom
901 W. Jackson Blvd., Chicago 7, Ill.
Branch Showroom: 265 Peachtree St., Atlanta 3, Ga.

For prompt service on Export Orders and Inquiries Address to Concord Radio Corp., Export Division, 901 W. Jackson Blvd., Chicago 7, Illinois.

INDISPENSABLE!

PHOTOFACT BOOKS



Photofact Television Course. Covers TV principles, operation and practice. 216 pages; profusely illustrated; 8½ x 11". Order TV-1 Only \$3.00

Television Antennas. New 2nd edition. Describes all TV antenna types; tells how to select, install, solve troubles. Saves time; helps you earn more. 200 pages; illustrated. Order TAG-1 Only \$2.00

Television Tube Location Guide. Accurate diagrams show position and function of all tubes in hundreds of TV sets; helps you diagnose trouble without removing chassis. 200 pages; pocket-size. Order TGL-1 Only \$1.50

1949-1950 Record Changer Manual. Vol. 3. Covers 44 models made in 1949, including multi-speed changers and wire and tape recorders. Original data based on actual analysis of equipment. 286 pages; 8½ x 11"; paper-bound. Order CM-3 Only \$3.00

1948-1949 Changer Manual. Vol. 2. Covers 45 models made in 1948-49. Paper bound. Order CM-2. Only \$4.95

1947-1948 Changer Manual. Vol. 1. Covers 40 post-war models up to 1948. Order CM-1 Only \$4.95

Recording & Reproduction of Sound. A complete authoritative treatment of all phases of recording and amplification. 6 x 9". Order RR-1 Only \$5.00



Post-War Audio Amplifiers. Vol. 2. A complete analysis of 104 well-known audio amplifiers and 12 well-known tuners made in 1949-50. 368 pages, 8½ x 11". Order AA-2 Only \$3.95

Post-War Audio Amplifiers. Vol. 1. Covers 102 amplifiers and FM tuners made through 1948. 352 pages. Order AA-1 Only \$3.95

Auto Radio Manual. Complete service data on more than 100 post-war auto radio models. Covers over 24 mfgrs. 350 pages, 8½ x 11". Order AR-1 Only \$4.95

Communications Receiver Manual. Complete analysis of 50 popular communications models. 246 pages, 8½ x 11". Order CR-1 Only \$3.00

Radio Receiver Tube Placement Guide. Accurate diagrams show where to replace each tube in 5500 radio models, covering 1938-1947 receivers. 192 pages, pocket-size. Order TP-1 Only \$1.25

Dial Cord Stringing Guide. Vol. 2. Covers receivers made from 1947 through 1949. Shows you the one right way to string a dial cord in thousands of models. Pocket-size. Order DC-2 Only \$1.00

Dial Cord Guide. Vol. 1. Covers sets produced 1938 through 1946. Order DC-1 Only \$1.00



The Famous "Radio and TV Industry RED BOOK"

New 2nd Edition. The complete one-volume guide to TV and Radio replacement parts for 22,000 sets made from 1938 through 1950.

Covers all 22 major components; 19 leading part manufacturers. Gives original part number, proper replacement numbers, valuable installation and service notes. Over 600 pages; 8½ x 11". Only \$3.95

Order from your Parts Jobber or write direct to
HOWARD W. SAMS & CO., INC., 2201 E. 46th St., Indianapolis 5, Indiana

HOWARD W. SAMS & CO., INC.

FM Provides Emergency Net

By JAMES A. FLYNN

COMMERCIAL FM Radio stations of the class-A, 1,000-watt type have a definite place in maintaining communications during emergencies, disasters, and war, as well as the bigger FM and AM stations. Any method of communications which seeks to control masses of people must do so while they are still thinking individuals and before they become rioting panic-stricken mobs. An informed person who knows what is going on and who is in constant contact with his block warden or sector warden is not liable to panic. If, in addition, he has been assigned definite tasks to perform, he is tractable and under control.



The emergency receiving equipment is very simple and can be used in any car.

The German breakthrough in the early part of World War II is a typical example of the need for control of civilian populations. The fleeing French people, spurred on by wild rumors (and in some cases effectively planted ones) completely blocked all roads. Proper routing of troop reinforcements and emergency vehicles was impossible. Such a condition could occur here in the United States. It is very likely that plans have already been formulated to stir up unrest, plant wild rumors, and block our highways with traffic tie-ups that would make our summer Sunday traffic jams look simple; and that these plans would immediately go into action in the event of all-out war.

To control these problems of evacuation, troop movements, and the numerous other difficulties facing a country under attack, many and often conflicting plans have been advocated. The bigger cities have special problems of their own, but the smaller outlying communities surrounding these large cities can be of great assistance in housing evacuees, supplying medical

care, and providing food and clothing to stricken areas. This is where the smaller radio stations, operating under emergency conditions, can do a spectacular job.

As station manager of WXNJ-FM, a class-A, 1,000-watt station located in Plainfield, N. J., about 25 miles from New York City, I conceived the plan of utilizing our facilities under test conditions, using as little special equipment as possible. Backed by the Quorum, a local group of business and professional men, the plan was taken up by the Plainfield Civil Defense Council under chairman Robert M. Read. On July 17, 1950, an actual test was made with excellent results.

We used Zenith Majors. (model 74-918) and power converters which have a male plug to plug into an automobile cigar lighter (Zenith part F-15840). These units were borrowed from Robert Mathewson of Zenith Radio, New York City. We also borrowed Link Radio monitoring receivers (v.h.f. type 2605) from Gene Bird of Link Radio, New York City. The radio transmitter was powered, for this test, by 7½-kw, portable gas-driven, a.c. 60-cycle, 110-220-volt generators with a voltage regulator.

The converters were plugged into cigar lighters in four police cars, 10 radio-equipped taxicabs, the mobile 10-meter ham car of Mr. Atkinson Alatory, W2UIY, and in a number of private cars stationed at designated spots as simulated sector warden posts. Using the FM radio receivers, these cars were then listening posts, ready for instructions and orders. The Link monitoring sets were tuned to the taxi and police frequencies, and with a 10-meter ham receiver we then had two-way communications—out on our own frequency (103.9 mc) and in on police, taxi, and



The author plugs a converter into a car lighter. The receiver is a Zenith Major.

RADIO-ELECTRONICS for

USE PHOTOFAC

the world's best Radio-TV service data—it pays for itself every working day



Try **PHOTOFAC!**

FREE We'll send you any Photofact Folder listed in the Photofact Cumulative Index

WE'LL PROVE YOU'LL SAVE TIME and EARN MORE WITH PHOTOFAC

NOW—learn for yourself—at our expense—how PHOTOFAC makes your Radio and TV work *quicker, easier, more profitable!* Examine an actual PHOTOFAC Folder. Use it. You'll learn first-hand why over 35,000 successful service technicians use PHOTOFAC daily. You'll learn that no other service gives you PHOTOFAC'S *completeness, accuracy, uniformity, and lowest cost.* PHOTOFAC is the *only* radio and TV service data prepared from laboratory analysis of the actual equipment. Know the facts—get your FREE Folder now. Examine, use, compare—learn why no modern service shop can afford to be without PHOTOFAC!

WRITE FOR FREE INDEX

PAY AS YOU EARN! Ask your distributor about this amazing plan. Only \$18.39 puts the entire profit-boosting Photofact library in your shop now!

NOTE: Our FREE Folder offer is limited to Service Technicians only. Attach coupon below to your letterhead and mention your jobber's name. If you have no letterhead, send coupon to your jobber. Experimenters and others may obtain the Photofact Folder by remitting amount shown below.

HOWARD W. SAMS & CO., INC.
2201 E. 46th St., Indianapolis 5, Ind.

- Send FREE Photofact Cumulative Index
- Send Full Easy-Pay Details

I am a Service Technician:

- Send FREE Folder for set model.....

I am an Experimenter: Enclosed \$.....

- Send Folder for set model.....

TV-\$1.00. Record Changer or Comm. Receiver-75c. AM/TM-50c

Name.....

Address.....

City.....Zone...State.....

amateur frequencies. The 7½-kw generator had been hooked up to our own transmitter and we were in operation. (We drew 2,700 watts.)

The entire test was run as though all telephone, power, and light lines had been destroyed. WXNJ, located on the top floor of the Plainfield National Bank, was used as control center. The mobile cars, taxi, and police were dispatched to various parts of the city to report back on simulated disaster conditions. The block wardens were given test instructions for billeting evacuees from other sectors and cities and to maintain road blocks in their own endangered sectors. The mobile ham rig made three standby contacts with out-of-area amateurs to prove our ability to maintain contact on a state-and nation-wide level. The entire test went off without any trouble.

The test was observed by New Jersey State Deputy Civil Defense Director Charles S. Weiler, and W. J. McGrath, on the Staff of General Lucius Clay, New York State Civil Defense Director. Both agreed as to results and stated: "The possibilities are unlimited." Mr. McGrath borrowed a Zenith Major and one of the cigar-lighter plug-in converters to demonstrate to his own group the practicality of this plan.

Costs in setting up this system on a permanent basis can be kept at a minimum. The most expensive item at present is the converter at \$35. On a production-line setup, however, this should drop considerably. The gas-powered generator should be installed on the premises and hooked up as a standby source of power. The local civil defense council, through its state organization, could obtain these, possibly from Government surplus supplies.

In Plainfield, N. J., there are only four police vehicles equipped with radio, but under our plan the town's two cab companies, on receipt of the first warning would send their ten taxis to police headquarters at once. These would be manned by regular and auxiliary police and sent to predetermined designated areas to patrol. The city would then be divided into fourteen patrolled areas with two-way communications instead of the four areas possible, were we to use police cars only.

Other emergency vehicles such as Red Cross would receive instructions from central headquarters. When the mission was complete, they would report back, as would all block and sector wardens, through the patrol car in their area.

The best thing about this plan, besides the fact that it works, is its simplicity. You need only enough monitoring receivers at headquarters to cover, one each, the different frequencies used out in the field. We used three. One receiver for the ham rig is needed, and as many converters as you have vehicles and block wardens working.

The Plainfield Civil Defense Council intends to use this method of communications should conditions warrant. Other cities or states are welcome to any assistance we may be able to render.



MORE THAN
50,000 TV SETS
MONTHLY
rightly rely on



J S C
Twin
Lead
300 ohm
Television
Transmission
Wire

TV manufacturer, installation engineer. TV sponsor and televiewer all form an inseparable chain, securely lined by the world's finest television transmission wire. J S C is justly proud of its important role in the development and progress of television. Rigid adherence to the principle of "quality before quantity" will pave the way to greater accomplishments for J S C!

Write for Descriptive Pamphlet.

JERSEY SPECIALTY CO.

Little Falls, New Jersey
All Phones:
Little Falls 4-0784, 1404, 1405



274N (ARC5) XMTTRS VFO DRIVERS 40 WATT OUTPUT



- 2-1-3MC 14.95
 - 3-4MC 19.95
 - 4-5-3MC 15.95
 - 5-3-7MC 15.95
 - 7-9-1MC 13.95
- Used. Good Cond.

T.V. Transformer, 7" or 9" 3000V, 75MA, 720Vet, \$2.00
M.A., 6.4/5A, 5/3A, 1.25/3A, 115V 60 cy. Input, Price \$3.95
400 MA 12 HY Choke 90 ohms Item. sealed. Special. \$3.75



BC 429 Receiver High sensitivity, 7.5 R.F. Complete with one dual tuning unit. Covering 200-400 KC and 2500 to 4700 KC with tubes. An ideal marine receiver for small boats and yachts. Now only \$3.95. Extra tuning unit, 1.95

Rated Concerns Send P.O. Minimum Order \$3.00
Send M.O. or CHK. Mds. Guard. Shpg. Charges
Send C.O.D. Price F.O.B. N.Y.C. Phone Dl. 9-4124

COMMUNICATIONS EQUIPMENT CO.

131 Liberty St. Dept. C2 New York City 7, N. Y.

GIBSON GIRL



The Emergency Radio Transmitter. Send S O S signals automatically on 500KC. 150-mile range. No batteries required. Has hand-driven generator tubes. wire. New. H's only \$3.40

ARC 5 MODULATOR M17/ARC5 w/dynamotor complete w/ Tubes 1-12J5, 2-1625, 1-VR50. Good cond. Price \$8.95

AMPLIFIER AM-32/PRSL less batt w/carry case for Mine Detector AN/PRSL. w/tubes Price ea. \$7.95

PHOTO EQUIP. Photo Material Ethyl Phthalate (East Kod) Approx. 1 Qt. Bottle \$3.95
Oetoniil Surface Cleaning Solution Photomat Apk. 1 Qt. \$3.95
Transparente #146 For Transparentizing Drawings & Tracing. Apk. 1 Qt. \$6.95

Model 542 Supreme Sensitivity. 5,000 Ohms/v 3" square meter. Reads: D.C. volts 6-150-300-1,000-5000; AC Volts, 6-10-150-600; D.C. ma., 0-3-6-30-150; Ohms 2,000-20,000-200,000, 2 megs; db.-6 to 4-50; Output, 4-30-150-600 volts; Bakelite case, 5-7x x 3-1/16 x 2-1/4" Shpg. wt. 2lbs. \$8.95 ea. Model 442 Rad C10, same as above. \$8.95 ea. Model 661-SC2563 Triplet VDC 3/30/300/300/300 VDC ohms 1000/10000/1000000/1 meg Price \$7.95 ea.

Model same as above Chicago. Price \$7.95
All above meters are sold in 1s. No refund minor repairs required.

RC-605 INTERPHONE AMPLIFIER Easily converted to an ideal inter-Community. Communications set for office-home-or factory. Original. New w/converter. Diagram \$4.49

Crystals for BC G84 Complete set of 120 Data from 27-38.9MC \$95.00
Xtals Low & High Freq. in Pt. 241 Holders. E. 1/2" Pin Spacing. Marked in Army Mc Harmonic freq. at most all freq's. \$6.99 ea.

BC 604 DM Transmitter. M 20-28 MC 11 & 15 Mtr. Can be made from 27-38.9MC \$95.00
10 Mtr. 10 Channel push button control w/tubes meter. Less xtals. Good used. Sold as is \$15.95
Set of 80 xtals \$25.00

GET RID OF B. O.*



in TV Pictures! * BARKHAUSEN OSCILLATION

When vertical black bars appear in TV pictures as shown above they are the result of Barkhausen Oscillation occurring in the horizontal sweep output tube (such as the 25BQ6, 6BQ6, 6EV5, 25EV5, 6AU5 or 25AU5 etc.). To correct this difficulty our engineers have developed the

PERFECTION B. O. ELIMINATOR



B. O. ELIMINATOR (Actual Size)

This compact device fits over the horizontal sweep output tube and because it brings a concentrated magnetic field near the source of the Barkhausen Oscillation—namely the screen grid—it usually eliminates the oscillation and the black lines on the face of the picture tube. . . . Service men who have used the B.O. Eliminator say it is the simplest and most positive method of getting rid of the vertical bars that they have ever known. They see a big demand by service men in maintaining the 10,000,000 TV sets now on the market.



EASY TO INSTALL

Just slip the B. O. Eliminator over the tube, move down, or up, or turn until the dark vertical bars disappear from the picture. Spring grip holds the Eliminator in place.

Order Today From Your Supplier!

PERFECTION ELECTRIC CO.

2645 South Wabash Avenue Chicago 16, Illinois

Makers of Perfection Speakers, Ion Traps and BeamaJuster TV Picture Centering Controls

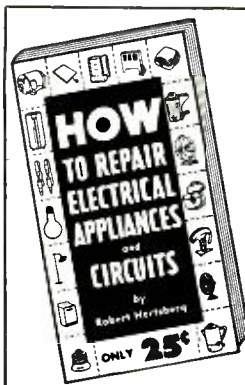

DON'T LET THE LOW PRICE MISLEAD YOU. Although it sells for only 25c this versatile pocket edition just off the press includes 28 photographs showing exactly how repairs are made for every electrical device from a fuse to a motor including electric toasters, irons, clocks, fans, vacuum cleaners, washing machines, bulbs, fluorescents, thermostats, transformers, radios, tubes, resistors, condensers, auto electrical circuits, house wiring, etc. Send for your postpaid copy today. Include 25c in coin or stamps. (Send \$1 and we will include an Electric Tester.) SUPERIOR PUBLISHING CO., DEPT. 5-13, 227 FULTON STREET, NEW YORK 7, N. Y.

CONVERTING A MOVIE PROJECTOR AMPLIFIER

? I am enclosing the circuit of a model 102 amplifier which I purchased from a Midwest radio mail-order house. This amplifier was designed for use with a portable movie projector. Please

qu岸ired with the average tuner. The 500,000-ohm control in the input circuit should be adjusted so the amplifier is not overloaded when the tuner volume control is set at maximum. The 6SN7

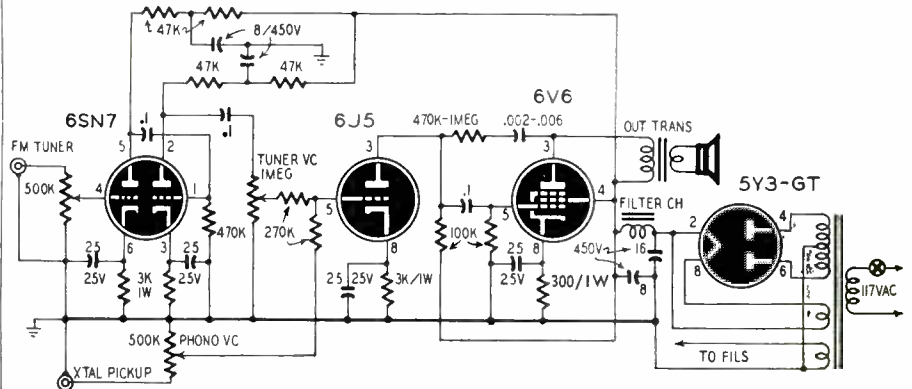

show how I can convert it for use with an FM tuner and a crystal pickup.—J. R. R., Suffolk, Va.

A. The conversion diagram is shown. The 6SN7 is connected as a cascade-connected amplifier for the FM tuner. Plate load resistors in this stage are made low because very little gain is

stage will provide sufficient gain for some crystal microphones.

The signals from the pickup and tuner are mixed in the grid circuit of the 6J5. The feedback loop between the plates of the 6J5 and 6V6 is to improve the frequency response. Experiment with the resistor and capacitor values.

VIBRATO AMPLIFIER FOR ELECTRONIC GUITAR

? I am constructing an electronic guitar and would like to have a diagram of a 10-watt amplifier to use with it. Please design an amplifier for me and include the vibrato circuit shown in the December, 1949, issue.—E. C. P., Takoma Park, D.C.

A. The amplifier circuit is shown. The phase inverter and push-pull output stages are conventional. The variable-gain stage is a 6SK7, two methods of controlling its gain being shown. In Fig. 1, the 6-cycle a.c. sine wave is applied to the control grid of the 6SK7 along with the signal to be amplified.

In the alternate method shown in Fig. 2, the oscillator signal is amplified and then rectified by the 6H6. The positive voltage from the 6H6 is applied as d.c. bias to the control grid of the 6SK7. The bias on this grid swings

positive at a 6-cycle rate causing the amplifier output to increase accordingly. If you want the vibrato circuit to decrease the volume, reverse the plate and cathode connections to the 6H6. A small capacitor may be connected be-

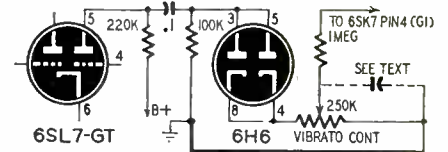

Fig. 2—Alternate circuit for vibrato.

tween the arm or the high side of the vibrato control and ground. The position and value of the capacitor will depend on the decay and attack time which sounds most pleasing to the operator. Try values as high as 0.3 μf.

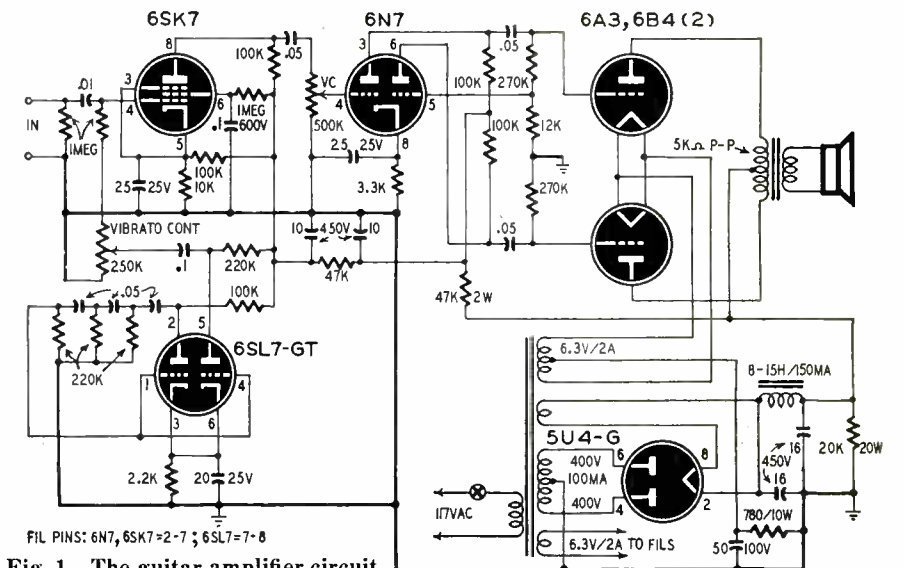

Fig. 1—The guitar amplifier circuit.

*You GET
THE BEST IN
Heathkits*

Heathkits are the Quality Line of TEST INSTRUMENT KITS



Modern STYLING KITS THAT MATCH

Heathkits are styled in the most modern manner by leading industrial stylists. They add beauty and utility to any laboratory or service bench. There is a complete line of Heathkit instruments allowing a uniformity of appearance.

An attractive service shop builds a feeling of confidence. Many organizations have standardized on Heathkits providing uniform service departments.

There is no waste space or false effort to appear large in Heathkits — space on service benches is limited and the size of Heathkit instruments is kept as small as is consistent with good engineering practice.



Accuracy ASSURED BY PRECISION PARTS

Wherever required, the finest quality 1% ceramic resistors are supplied. These require no aging and do not shift. No matching of common resistors is required. You find in Heathkit the same quality voltage divider resistors as in the most expensive equipment.

The transformers are designed especially for the Heathkit unit. The scope transformer has two electrostatic shields to prevent interaction of AC fields.

These transformers are built by several of the finest transformer companies in the United States.

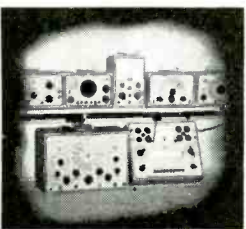

Used BY LEADING MANUFACTURERS

Leading TV and radio manufacturers use hundreds of Heathkits on the assembly lines. Heathkit scopes are used in the alignment of TV tuners. Impedance bridges are serving every day in the manufacture of transformers. Heathkit VTVM's are built into the production lines and test benches. Many manufac-

turers assemble Heathkits in quantity for their own use thus keeping purchase cost down.

Famous HEATHKIT PARTS

- MALLORY FILTER CONDENSERS
- WILKOR PRECISION RESISTORS
- GRIGSBY ALLISON SWITCHES
- ALLEN-BRADLEY RESISTORS
- GENERAL ELECTRIC TUBES
- CHICAGO TRANSFORMER
- CENTRALAB CONTROLS
- SIMPSON METERS
- CINCH SOCKETS

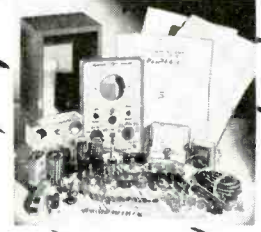

Complete KITS WITH PARTS THAT FIT...

When you receive your Heathkit, you are assured of every necessary part for the proper operation of the instrument.

Beautiful cabinets, handles, two-color panels, all tubes, test leads where they are a necessary part of the instrument, quality rubber line cords and plugs, rubber feet for each instrument, all scales and dials ready printed and calibrated. Every Heathkit is 110 V 60 Cy. power transformer operated by a husky transformer especially designed for the job. Heathkit chassis are precision punched for ease of assembly. Special engineering for simplicity of assembly is carefully considered.



Complete INSTRUCTION MANUALS

Heathkit instruction manuals contain complete assembly data arranged in a step-by-step manner. There are pictorials of each phase of the assembly drawn by competent artists with detail allowing the actual identification of parts.

Where necessary, a separate section is devoted to the use of the instrument. Actual photos are included to aid in the proper location of wiring.

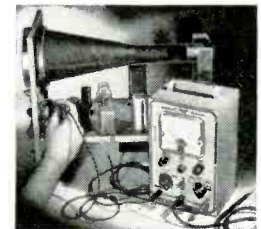

Used BY LEADING UNIVERSITIES

Heathkits are found in every leading university from Massachusetts to California. Students learn much more when they actually assemble the instrument they use. Technical schools often include Heathkits in their course and these become the property of the students. High schools, too, find that the purchase of inexpensive Heathkits allows their budget to go much further and provides much more complete laboratories.

YOU SAVE BY ORDERING DIRECT FROM MANUFACTURER—USE ORDER BLANK ON LAST PAGE

EXPORT AGENT
ROCKE INTERNATIONAL CORP.
13 E. 40th ST.
NEW YORK CITY (16)
CABLE: ARLAB-N.Y.

The HEATH COMPANY

... BENTON HARBOR 20, MICHIGAN

12 Improvements IN NEW 1951

MODEL O-6

PUSH-PULL

Heathkit OSCILLOSCOPE KIT

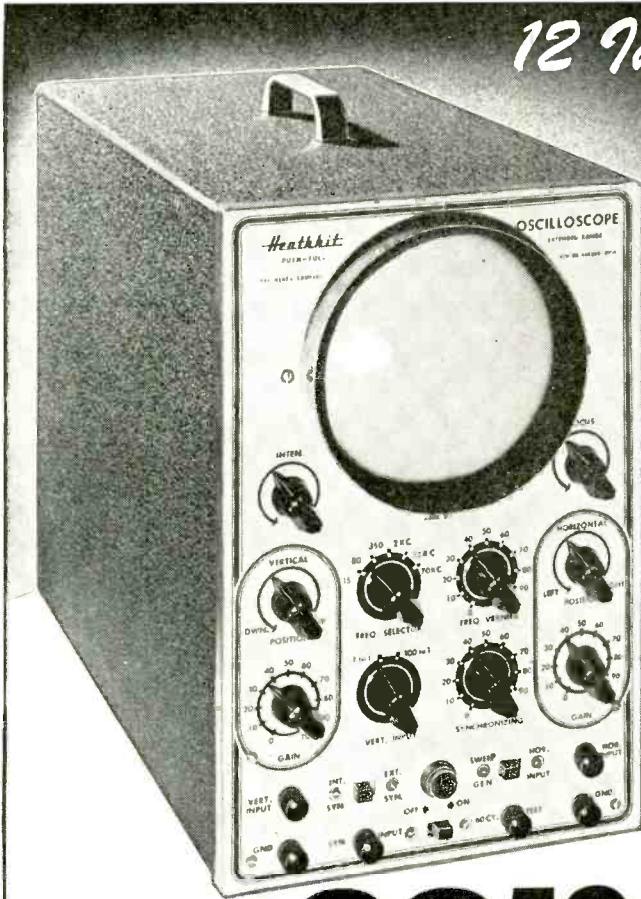

Only **\$39⁵⁰**

New INEXPENSIVE MODEL S-2 ELECTRONIC SWITCH KIT

Twice as much fun with your oscilloscope — observe two traces at once — see both the input and output traces of an amplifier, and amazingly you can control the size and position of each trace separately — superimpose them for comparison or separate for observation — no connections inside scope. All operation electronic, nothing mechanical — ideal for classroom demonstrations — checking for intermittents, etc. Distortion, phase shift and other defects show up instantly. Can be used with any type or make of oscilloscope. So inexpensive you can't afford to be without one.

Has individual gain controls, positioning control and coarse and fine switching rate controls — can also be used as square wave generator over limited range. 110 Volt transformer operated comes complete with tubes, cabinet and all parts. Occupies very little space beside the scope. Better get one. You'll enjoy it immensely. Model S-2. Shipping Wt., 11 lbs.



Only
\$19⁵⁰

- ★ New AC and DC push-pull amplifier.
- ★ New step attenuator frequency compensated input.
- ★ New non frequency discriminating input control.
- ★ New heavy duty power transformer has 68% less magnetic field.
- ★ New filter condenser has separate vertical and horizontal sections.
- ★ New intensity circuit gives greater brilliance.
- ★ Improved amplifiers for better response useful to 2 megacycles.
- ★ High gain amplifiers .04 Volts RMS per inch deflection.
- ★ Improved Allegheny Ludlum magnetic metal CR tube shield.
- ★ New synchronization circuit works with either positive or negative peaks of signal.
- ★ New extended range sweep circuit 15 cycles to over 100,000 cycles.
- ★ Both vertical and horizontal amplifier use push-pull pentodes for maximum gain.

The new 1951 Heathkit Push-Pull Oscilloscope Kit is again the best buy. No other kit offers half the features — check them.

Measure either AC or DC on this new scope — the first oscilloscope under \$100.00 with a DC amplifier.

The vertical amplifier has frequency compensated step attenuator input into a cathode follower stage. The gain control is of the non frequency discriminating type — accurate response at any setting. A push-pull pentode stage feeds the C.R. tube. New type positioning control has wide range for observing any portion of the trace.

The horizontal amplifiers are direct coupled to the C.R. tube and may be used as either AC or DC amplifiers. Separate binding posts are provided for AC or DC.

The multivibrator type sweep generator has new frequency compensation for the high range it covers; 15 cycles to cover 100,000 cycles.

The new model O-6 Scope uses 10 tubes in all — several more than any other. Only Heathkit Scopes have all the features.

New husky heavy duty power transformer has 50% more laminations. It runs cool and has the lowest possible magnetic field. A complete electrostatic shield covers primary and other necessary windings and has lead brought out for proper grounding.

The new filter condenser has separate filters for the vertical and horizontal screen grids and prevents interaction between them.

An improved intensity circuit provides almost double previous brilliance and better intensity modulation.

A new synchronization circuit allows the trace to be synchronized with either the positive or negative pulse, an important feature in observing the complex pulses encountered in television servicing.

The magnetic alloy shield supplied for the C.R. tube is of new design and uses a special metal developed by Allegheny Ludlum for such applications.

The Heathkit scope cabinet is of aluminum alloy for lightness of portability.

The kit is complete, all tubes, cabinet, transformer, controls, grid screen, tube shield, etc. The instruction manual has complete step-by-step assembly and pictorials of every section. Compare it with all others and you will buy a Heathkit. Model O-6. Shipping Wt., 30 lbs.

YOU SAVE BY ORDERING DIRECT FROM MANUFACTURER—USE ORDER BLANK ON LAST PAGE

EXPORT AGENT
ROCKE INTERNATIONAL CORP.
13 E. 40th ST.
NEW YORK CITY (16)
CABLE: ARLAB-N.Y.

The HEATH COMPANY

... BENTON HARBOR 20, MICHIGAN

New 1951 • • MODEL V-4A

Heathkit VTVM KIT

HAS EVERY EXPENSIVE Feature

- ★ Higher AC input impedance, (greater than 1 megohm at 1000 cycles).
- ★ New AC voltmeter flat within 1 db 20 cycles to 2 megacycles (600 ohm source).
- ★ New accessory probe (extra) extends DC range to 30,000 Volts.
- ★ New high quality Simpson 200 microampere meter.
- ★ New 1/2% voltage divider resistors (finest available).
- ★ 24 Complete ranges.
- ★ Low voltage range 3 Volts full scale (1/3 of scale per volt).
- ★ Crystal probe (extra) extends RF range to 250 megacycles.
- ★ Modern push-pull electronic voltmeter on both AC and DC.
- ★ Completely transformer operated isolated from line for safety.
- ★ Largest scale available on streamline 4 1/2 inch meter.
- ★ Burn-out proof meter circuit.
- ★ Isolated probe for dynamic testing no circuit loading.
- ★ New simplified switches for easy assembly.

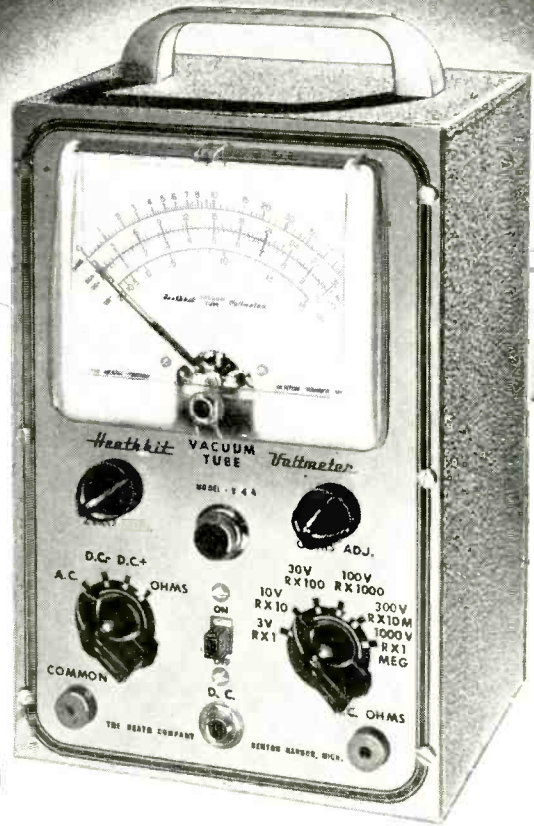

New
LOW PRICE **\$23.50**

The new Heathkit Model V-4A VTVM Kit measures to 30,000 Volts DC and 250 megacycles with accessory probes — think of it, all in one electronic instrument more useful than ever before. The AC voltmeter is so flat and extended in its response it eliminates the need for separate expensive AC VTVM's. + or - db from 20 cycles to 2 megacycles. Meter has decibel ranges for direct reading. New zero center on meter scale for quick FM alignment.

There are six complete ranges for each function. Four functions give total of 24 ranges. The 3 Volt range allows 33 1/3% of the scale for reading one volt as against only 20% of the scale on 5 Volt types.

The ranges decade for quick reading.

New 1/2% ceramic precision are the most accurate commercial resistors available — you find the same make and quality in the finest laboratory equipment selling for thousands of dollars. The entire voltage divider decade uses these 1/2% resistors.

New 200 microampere 4 1/2" streamline meter with Simpson quality movement. Five times as sensitive as commonly used 1 MA meters.

Shatterproof plastic meter face for maximum protection. Both AC and DC voltmeter use push-pull electronic voltmeter circuit with burn-out proof meter circuit.

Electronic ohmmeter circuit measures resistance over the amazing range of 1/10 ohm to one billion ohms all with internal 3 Volt battery. Ohmmeter batteries mount on the chassis in snap-in mounting for easy replacement.

Voltage ranges are full scale 3 Volts, 10 Volts, 30 Volts, 100 Volts, 300 Volts, 1000 Volts. Complete decading coverage without gaps.

The DC probe is isolated for dynamic measurements. Negligible circuit loading. Gets the accurate reading without disturbing the operation of the instrument under test. Kit comes complete, cabinet, transformer, Simpson meter, test leads, complete assembly and instruction manual. Compare it with all others and you will buy a Heathkit. Model V-4A. Shipping Wt., 8 lbs. Note new low price, \$23.50



New 30,000 VOLT DC PROBE KIT

Beautiful new red and black plastic high voltage probe. Increases input resistance to 1100 megohms, reads 30,000 Volts on 300 Volt range. High input impedance for minimum loading of weak television voltages. Has large plastic insulator rings between handle and point for maximum safety. Comes complete with PL55 type plug.

No. 3366 High Voltage Probe Kit.
Shipping Wt., 2 pounds.

\$550

Heathkit RF PROBE KIT

Crystal diode probe kit extends range to 250 megacycles = 10% comes complete with all parts, crystal, cable and PL55 type plug.

No. 309 RF Probe Kit
Shipping Wt., 1 lb.

\$550



YOU SAVE BY ORDERING DIRECT FROM MANUFACTURER — USE ORDER BLANK ON LAST PAGE

EXPORT AGENT
ROCKE INTERNATIONAL CORP.
13 E. 40th ST.
NEW YORK CITY (16)
CABLE: ARLAB-N.Y.

The HEATH COMPANY

... BENTON HARBOR 20, MICHIGAN

NEW Heathkit T.V. ALIGNMENT GENERATOR KIT



Shipping Wt., 16 lbs.

\$39.50

- ★ New simplified circuit for easy calibration and assembly.
- ★ New 2 band built-in marker covers 19 to 75 Mc.
- ★ New dual spider sweep motor for long life.
- ★ New blanking circuit gives base line for better alignment.
- ★ New variable oscillator gives high output fundamentals on high TV band.
- ★ New standby switch keeps instrument ready for instant use.
- ★ New 6 to 1 slow speed drive on both master oscillator and marker tuners.

The new Heathkit TV Alignment Generator incorporates the new developments required for modern TV servicing. An absorption marker circuit covering all possible IF bands and even several of the RF bands. The new blanking circuit provides a base reference line which is invaluable in establishing proper traces. The new sweep motor incorporates dual spiders in the speaker frame assuring better alignment and long life. The mounting of the speaker sweep motor has been simplified for easy alignment.

The variable master oscillator covers 140 to 230 Mc. thus giving high output fundamentals where they are most needed. Low band coverage 2 Mc. to 90 Mc.

A new step attenuator provides excellent control of output.

Planetary 6 to 1 drives on both oscillator and marker provides smooth easy control settings.

A standby position is provided making the instrument always instantly available.

Horizontal sweep voltage with phasing control is provided. No other sweep generator under \$100.00 provides all these features — comes complete with instruction manual. Model TS-2.

Heathkit CONDENSER CHECKER KIT

Only **\$19.50**

- Features*
- Power factor scale.
 - Measures resistance.
 - Measures leakage.
 - Checks paper-mica-electrolytics.
 - Bridge type circuit.
 - Magic eye indicator.
 - 110 V. transformer operated.
 - All scales on panel.



Checks all types of condensers over a range of .00001 MFD to 1,000 MFD. All on readable scales that are read direct from the panel. NO CHARTS OR MULTIPLIERS NECESSARY. A condenser checker anyone can read. A leakage test and polarizing voltage for 20 to 500 Volts provided. Measures power factor of electrolytics between 0% and 50%. 110 V. 60 cycle transformer operated complete with rectifier and magic eye tube, cabinet, calibrated panel, test leads and all other parts. Clear detailed instructions for assembly and use. Model C-2. Shipping Wt., 7 lbs.

NEW Heathkit SIGNAL TRACER AND UNIVERSAL TEST SPEAKER KIT

\$19.50

- Features*
- High sensitivity
 - Complete set of speaker impedances
 - Tests microphones and PA systems
 - Tests both single and push-pull speaker circuits

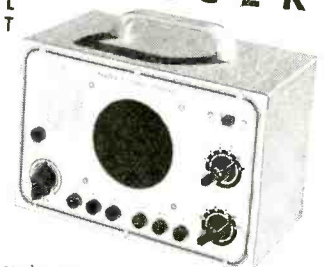

The popular Heathkit Signal Tracer has now been combined with a universal test speaker at no increase in price. The same high quality tracer follows signal from antenna to speaker. The same high quality tracer locates parts quicker — saves valuable service time — gives greater income per service hour. Works equally well on broadcast — FM or TV receivers. The test speaker has assortment of switching ranges to match push-pull or single output impedance. Also test microphones, power transformer — tubes, test probe, all parts and detailed instructions for assembly and use. Model T-2. Shipping Wt., 8 lbs.

Heathkit TUBE CHECKER KIT

- Features*
- Sockets for every modern tube — blank for new types.
 - Fastest method of testing tubes — saves time — makes more profit.
 - Rugged counter type birch cabinet.
 - Gear driven roller chart gives instant setup for all types.
 - Tests each element separately for open or short and quality.
 - Beautiful 3 color meter — reads good-bad and line set point.

Test your tubes the modern way — dynamically — the simplest, yet fastest and surest method — your Heathkit has a switch for each tube element and measures that element — no chance for open or shorted elements slipping by, all the advantages of the mutual conductance type without the slow cumbersome time consuming setups.

Your Heathkit Tube Checker has all the features — beautiful 3 color BAD-GOOD meter — complete selection of voltages — roller chart listing hundreds of tubes including the new 9 pin miniatures — finest quality Centralab lever switches for each element — high grade birch counter type cabinet — continuously variable line adjust control — every feature you need to sell tubes properly. The most modern type tube checker with complete protection against obsolescence. The best of parts — rugged oversize 110 V. 60 cycle power transformer — finest of Mallory and Centralab switches and controls, complete set of sockets for all type tubes with blank spare for future types. Fast action brass gear driven roller chart quickly locates the settings for any type tube. Simplified switching cuts necessary testing time to minimum and saves valuable service time. Short and open element check. Simple method allows instant setup of new tube types without waiting for factory data. No matter what the arrangements of tube elements, the Heathkit flexible switching arrangement easily handles it. Order your Heathkit Tube Checker Kit today. See for yourself that Heath again saves you two-thirds and yet retains all the quality — this tube checker will pay for itself in a few weeks — better assemble it now. Complete with instructions — pictorial diagrams — all parts — cabinet — ready to wire up and operate. Model TC-1 Shipping Wt., 12 lbs.

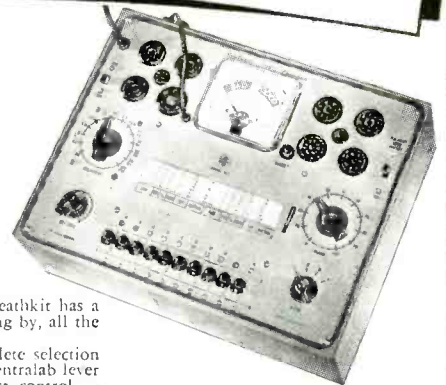

\$29.50

YOU SAVE BY ORDERING DIRECT FROM MANUFACTURER — USE ORDER BLANK ON LAST PAGE

REPORT AGENT
ROCKE INTERNATIONAL CORP.
13 E. 40th ST.
NEW YORK CITY (16)
CABLE: ARLAB-N Y.

The HEATH COMPANY

... BENTON HARBOR 20, MICHIGAN

NEW 1951 *Heathkit* SIGNAL GENERATOR KIT

Features

- Sine wave audio modulation.
- Extended range 160 Kc. to 50 megacycles fundamentals.
- New step attenuator output.
- New miniature HF tubes.
- Transformer operated for safety.
- Calibrated harmonics to 150 megacycles.
- New external modulation switch.
- 5 to 1 vernier tuning for accurate settings.

A completely new Heathkit Signal Generator Kit. Dozens of improvements. The range on fundamentals has been extended to over 50 megacycles; makes this Heathkit ideal as a marker oscillator for T.V. New step attenuator gives controlled outputs from very low values to high output. A continuously variable control is used with each step. New miniature HF tubes are required for the high frequencies covered.

Uses 6C4 master oscillator and 6C4 sine wave audio oscillator. The set is transformer operated and a husky selenium rectifier is used in the power supply. The coils are precision wound and checked for calibration making only one adjustment necessary for all bands.

New sine wave audio oscillator provides internal modulation and is also available for external audio testing. Switch provided allows the oscillator to be modulated by an external audio oscillator for fidelity testing of receivers.

A best buy — think of all the features for less than \$20.00. The entire coil and tuning assembly are assembled on a separate turret for quick assembly — comes complete — all tubes — cabinet — test leads — every part. The instruction manual has step-by-step instructions and pictorials. It's easy and fun to build a Heathkit Model SG-6 Signal Generator. Shipping Wt., 7 lbs.



\$19.50

Heathkit SINE AND SQUARE WAVE AUDIO GENERATOR KIT

Either sine or square wave.
Stable RC bridge circuit.
Covers 20 to 20,000 cycles.
Less than 1% distortion.



Hundreds of Heathkit Audio Generators are used by speaker manufacturers—definite proof of their quality and dependability. The added feature of square wave opens up an entirely new field of amplifier testing. Uses the best of parts, 4 gang condenser, 1% calibrating resistors, metal cased filter condensers, 5 tubes, completely calibrated panel and detailed instruction manual. One of our best and most useful kits. Model G-2. Shipping Wt., 12 lbs.

\$34.50

THE NEW *Heathkit* HANDITESTER KIT

- Beautiful streamline Bakelite case.
- AC and DC ranges to 5,000 Volts.
- 1% Precision ceramic resistors.
- Convenient thumb type adjust control.
- 400 Microampere meter movement.
- Quality Bradley AC rectifier.
- Multiplying type ohms ranges.
- All the convenient ranges 10-30-300-1,000-5,000 Volts.
- Large quality 3" built-in meter.



\$13.50

A precision portable volt-ohm-milliammeter. An ideal instrument for students, radio service, experimenters, hobbyists, electricians, mechanics, etc. Rugged 400 ua meter movement. Twelve complete ranges, precision dividers for accuracy. Easily assembled from complete instructions and pictorial diagrams. An hour of assembly saves one-half the cost. Order today. Model M-1. Shipping Wt., 2 lbs.

NEW *Heathkit* BATTERY ELIMINATOR KIT

Features

- Provides variable DC voltage for all checks.
- Locates sticky vibrators-intermittents.
- Voltmeter for accurate check.
- Has 4000 MFD Mallory filter for ripple-free voltage.



\$22.50

Even the smallest shop can afford the Heathkit Battery Eliminator Kit. A few auto radio repair jobs will pay for it. It's fast for service, the voltage can be lowered to find sticky vibrators or raised to ferret out intermittents. Provides variable DC voltage 5 to 7½ Volts at 10 Amperes continuous or 15 Amperes intermittent. Also serves as storage battery charger. Ideal for all auto radio testing and demonstrating.

A well filtered rugged power supply uses heavy duty selenium rectifier, choke input filter with 4,000 MFD of electrolytic filter for clean DC. 0-15 V. voltmeter indicates output which is variable in eight steps. Easily constructed in a few hours from our instructions and diagrams — better be equipped for all types of service — it means more income. Model BE-2. Shipping Wt., 19 lbs.

YOU SAVE BY ORDERING DIRECT FROM MANUFACTURER—USE ORDER BLANK ON LAST PAGE

EXPORT AGENT
ROCKE INTERNATIONAL CORP.
12 E. 40th ST.
NEW YORK CITY (16)
CABLE: ARIAB-N.Y.

The **HEATH COMPANY**

... BENTON HARBOR 20, MICHIGAN

New
**LABORATORY
INSTRUMENT KITS**

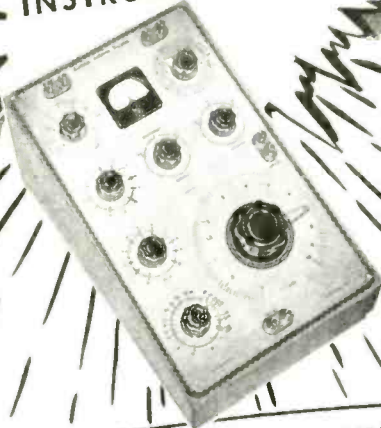

HUNDREDS OF LABORATORIES USE
Heathkit **IMPEDANCE BRIDGE** as Standard

Features

- Measures inductance 10 microhenries to 100 henries • Measures resistance .01 ohms to 10 megohms • Measures capacitance .00001 MFD to 100 MFD • Measures "Q" and power factor.

Measures inductance from 10 microhenries to 100 henries, capacitance from .00001 MFD to 100 MFD. Resistance from .01 ohms to 10 megohms. Dissipation factor from .001 to 1. "Q" from 1 to 1,000. Ideal for schools, laboratories, service shops, serious experimenters. An impedance bridge for everyone — the most useful instrument of all, which heretofore has been out of the price range of serious experimenters and service shops. Now at the lowest price possible. All highest quality parts. General Radio main calibrated control. General Radio 1,000 cycle hummer. Mallory ceramic switches with 60 degree indexing — 200 microamp type binding posts with standard 3/4" centers. Beautiful birch cabinet. Directly calibrated "Q" and dissipation factor scales. Ready calibrated capacity and inductance standards of Silver Mica, accurate to 1/2 of 1% and with dissipation factors of less than 30 parts in one million. Provisions on panel for external generator and detector. Measure all your unknowns the way laboratories do — with a bridge for accuracy and speed.

\$69.50

Internal 6 Volt battery for resistance and hummer operations. Circuit utilizes Wheatstone, Hay and Maxwell circuits for different measurements. Supplied complete with every quality part — all calibrations completed and instruction manual for assembly and use. Deliveries are limited. Model IB-1. Shipping Wt., 15 lbs.

**NEW Heathkit LABORATORY
RESISTANCE DECADE KIT**
Features



- 1/2% Accuracy
- Birch Cabinet
- Ceramic Switches
- Covers 1 ohm to 99,999 ohms

The new Heathkit Resistance Decade is a handy tool for laboratory, school and service shop. Ideal for test setups, calibrating instruments, bridge measurements, selecting multipliers, etc.

\$19.50

Uses the finest Centralab ceramic switches, 1/2% ceramic decade resistors and heavy birch cabinet matching other laboratory equipment. The range is 1 ohm to 99,999 ohms in one ohm steps.

Finest quality throughout to withstand school usage — heavy aluminum panel — laboratory type binding posts — the fine decades are extremely simple to assemble — complete kit. Model RD-1. Shipping Wt., 4 lbs.

**NEW Heathkit LABORATORY
POWER SUPPLY KIT**
Features

- Supplies 6.3 V. AC at 4.5 Amps.
- Heavy duty construction.
- Handy for schools, labs., and service shops.
- Supplies variable DC 50-300 Volts.
- Shows voltage or current on 3 1/2" meter.

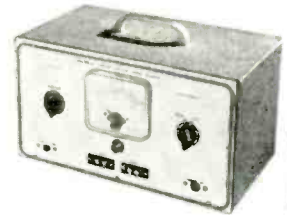

\$29.50

This new Heathkit Variable Power Supply Kit fills hundreds of needs — use it for experimental circuits — no need to build a separate power supply — use it for a test voltage to determine proper coefficients in unknown circuits — calibrate instruments with its variable voltage, etc. This new Heathkit supplies 50 to 300 Volts continuously variable DC together with an AC filament voltage of 6.3 Volts at 4.5 Amperes. A built-in 1 MA 3 1/2" meter has proper shunts to read 0-500 Volts and 0-200 Milliampers. The circuit uses a 5Y3 rectifier, two 1619 tubes as electronic control 7 1/8" x 13" x 7 1/8". Has instruction manual for assembly and use. Model PS-1. Shipping Wt., 18 lbs.

Heathkit **RECEIVER & TUNER KITS for AM and FM**

TWO HIGH QUALITY *Heathkit* SUPERHETERODYNE
RECEIVER KITS

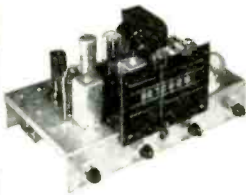

Model BR-1 Broadcast Model Kit covers 550 to 1600 Kc. Shipping Wt., 10 pounds.

\$19.50

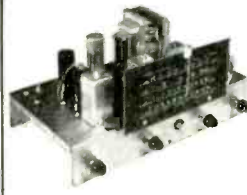

Model AR-1 3 Band Receiver Kit covers 550 Kc. to over 20 Mc. continuous. Extremely high sensitivity. Shipping Wt., 10 lbs.

\$23.50

Two new Heathkits. Ideal for schools, replacement of worn out receivers, amateurs and custom installations.

Both are transformer operated quality units. The best of materials are used throughout — six inch calibrated slide rule dial — quality power and output transformers — dual iron core shielded I.F. coils — metal filter condensers and all other parts. The chassis has phono input jack — 110 Volt outlet for phono motor and there is a phono-radio switch on panel. A large metal panel simplifying installation in used console cabinets is included. Comes complete with tubes and instruction manual incorporating pictorials and step-by-step instructions (less speaker and cabinet). The three band model has simple coil turret which is assembled separately for ease of construction.

TRUE FM FROM *Heathkit*
FM TUNER KIT

\$22.50

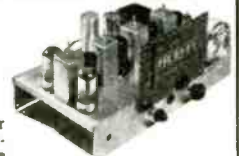

The Heathkit FM Tuner Model FM-2 was designed for best possible tonal reproduction. The circuit incorporates the most desirable FM features — true FM — ready wound and adjusted coils — 3 stages of 10.7 Mc. I.F. (including limiter).

Tube lineup: 7E5 oscillator, 6SH7 mixer, two 6SH7 I.F. stages, 6SH7 limiter, two 7C4 diodes as discriminator, 6X5 rectifier.

The instrument is transformer operated making it safe for connection to any type receiver or amplifier. The R.F. coils are ready wound — mounted on the tuning condenser and the condenser is adjusted — no R.F. coils to wind or adjust.

A calibrated six inch slide rule dial has vernier drive for easy tuning. The finest parts are provided with all tubes, punched and formed chassis, transformers, condensers and complete instruction manual. Model FM-2. Shipping Wt., 10 lbs.

EXPORT AGENT
ROCKE INTERNATIONAL CORP.
13 E. 40th ST.
NEW YORK CITY (16)
CABLE: ARLAB N.Y.

The **HEATH COMPANY**

... BENTON HARBOR 20, MICHIGAN

ENJOY MUSIC AT ITS *Finest* WITH *Heathkit* AMPLIFIERS

NEW *Heathkit* HIGH FIDELITY 20 WATT AMPLIFIER KIT



\$21.50

Features

- Push-pull 6L6's.
- Full 20 Watts output.
- Fully enclosed chassis.
- Provisions for reluctance pickup compensation stage.
- Cased high fidelity output transformer.
- Treble and bass boost tone controls.
- Full range of output impedances 3.2 ohms to 500 ohms.

The finest amplifier kit we have ever offered — check the features. This inexpensive amplifier compares favorably with instruments costing five times as much. Nothing has been spared to provide the best reproduction — an ideal amplifier for the new Heathkit FM Tuner listed below.

Dual tone controls for control of both treble and bass. Bass control is of the boost type for maximum listening pleasure. Optional preamplifier stage for use with G. E. reluctance pickup or microphone. Uses inverse feedback to give excellent response over entire range. Tube lineup: 6SJ7 preamplifier stage, 6J5 phase splitter stage, two 6L6's in push-pull and 5Y3 rectifier. (6SC7 as optional compensation stage).

Uses highest quality Chicago Transformer Corporation cased output transformer with taps of 3.2, 8, 15, 60 and 500 ohms to match any speaker combination. Power transformer is conservatively rated for continuous operation in sound systems. Tone control gives maximum bass boost of 6 db at 70 cycles. Amplifier has maximum gain of 75 db. Response within 3 db 20 to 20,000 cycles. Shipping Wt., 17 lbs. Complete with all parts, tubes and instruction manual.

Model A-5A Amplifier with preamplifier for G. E. cartridges or microphone \$23.50
12" 20 Watt Speaker, No. 326 7.50

Heathkit ECONOMY 6 WATT PUSH-PULL AMPLIFIER KIT



\$12.50

No. 304,
12-inch Speaker... **\$6.95**

This new Heathkit Amplifier was designed to give quality reproduction at a very low price. Has two preamp stages, phase inverter stage and push-pull beam power output. Comes complete with six tubes, quality output transformer (to 3-4 ohm voice coil), husky cased power transformer and all other parts. Has tone and volume controls. Instruction manual has pictorial for easy assembly. Six watt output with response flat $\pm 1\frac{1}{2}$ db from 50 to 15,000 cycles. A quality amplifier kit at new low price. Better build one. Model A-4. Shipping Wt., 7 lbs.

Heathkit RECEIVERS and TUNER CABINETS

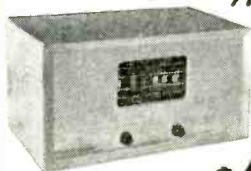

\$4.95

Order No. 350 for FM tuner

Blonde birch veneer cabinet for either the receivers or tuner. Modern styling is an asset to any room. 5" speaker fits in end of cabinet when used with receivers. Size 7 x 13 $\frac{1}{2}$ x 8 $\frac{1}{4}$ inches. Shipping Wt., 5 lbs. Order No. 345 for either receiver

Metal professional type communications receiver cabinet. Finished in deep grey to fit the panel supplied with Heathkit BR-1 and AR-1 Receivers (panel shown not included with cabinet). 5" speaker mounts in end of cabinet. Gives professional appearance to Heathkit receivers. Size 7 x 14 x 7 $\frac{3}{4}$ inches. Shipping Wt., 6 lbs.

5" Permoflux Speaker for either cabinet for use with either Heathkit Receiver No. 320 5" Speaker \$2.75



\$4.50

No. 335 Cabinet for receivers only.

ORDER BLANK

To HEATH COMPANY
BENTON HARBOR 20,
MICHIGAN

From _____

SHIP VIA

- Parcel Post
 Express
 Freight
 Best Way

(PLEASE PRINT)

Quantity	Item	Price	Quantity	Item	Price
	Heathkit Oscilloscope Kit — Model O-6			Heathkit VTVM Kit — Model V-4A	
	Heathkit T.V. Alignment Gen. Kit — TS-2			Heathkit R.F. Probe Kit — No. 309	
	Heathkit FM Tuner Kit — FM-2			Heathkit H.V. Probe Kit — No. 336	
	Heathkit Broadcast Receiver Kit — Model BR-1			Heathkit R.F. Signal Gen. Kit — Model SG-6	
	Heathkit Three Band Receiver Kit — Model AR-1			Heathkit Condenser Checker Kit — Model C-2	
	Heathkit Amplifier Kit — Model A-4			Heathkit Handitester Kit — Model M-1	
	Heathkit Amplifier Kit — Model A-5 (or A-5A)			Heathkit Variable Power Supply Kit — Model PS-1	
	Heathkit Tube Checker Kit — Model TC-1			Heathkit Resistance Decode Kit — Model RD-1	
	Heathkit Audio Generator Kit — Model G-2			Heathkit Impedance Bridge Kit — Model IB-1	
	Heathkit Battery Eliminator Kit — Model BE-2			Heathkit Signal Tracer Kit — Model T-2	
	Heathkit Electronic Switch Kit — Model S-2				

On Parcel Post Orders, include postage for weight shown and insurance. (We insure all shipments.)

On Express Orders, do not include transportation charges — they will be collected by the Express Agency at time of delivery.

Enclosed find Check Money Order for _____

Please ship C.O.D. Postage enclosed for _____ lbs.

EXPORT AGENT
ROCKE INTERNATIONAL CORP.
13 E. 40th ST.
NEW YORK CITY 16
CABLE: ARAL-N.Y.

The HEATH COMPANY

... BENTON HARBOR 20, MICHIGAN

IT'S **NEW!**
IT'S A **NATIONAL!**



\$49⁹⁵

SW-54

*the most compact
general coverage
receiver
ever built!*

- 540kc — 30mc
- VOICE
- MUSIC
- CODE

Designed especially for the shortwave fan, the new SW-54 covers ship, police, amateur, foreign and standard broadcast bands. Yet it's housed in a smart, modern, unbreakable metal cabinet that measures only 11" x 7" x 7". Uses new miniature tubes in superheterodyne circuit, for astonishing sensitivity. Unique adjustable plastic bandspread dial assures logging accuracy over entire range. AC/DC operation. Write for details and name of nearest supplier to Dept. D



HANDY SUBSTITUTION BOX

A combination capacitor substitution box and headphone adapter for a.f. signal tracing is a handy piece of equipment to have on your workbench. This unit consists of 11 fixed capacitors which may be connected to circuits under test and two blocking capacitors which are inserted in series with the phone leads when the selector switch is

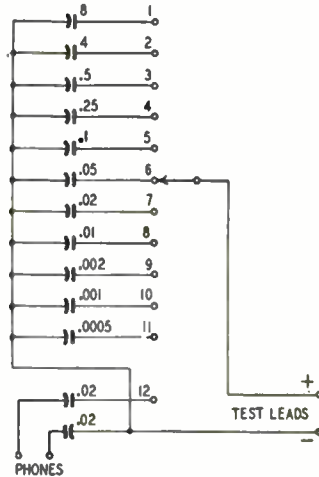

turned to position 12. You can use the capacitor values shown in the drawing or values most often encountered in your work.

To use the unit as an audio signal tracer, set the selector switch on position 12, plug in the headphones, and use; connect the test prods to the circuit under test.—*John W. Cook*

HANDY TROUBLE LIGHT

Some Christmas-tree lights have candelabra-type sockets with small clips fastened to them. When fitted with a suitable line cord and a 115-volt pilot lamp, these make handy trouble lights for illuminating dark corners of a chassis. If the leads are fitted with insulated clips, power can be taken from the set under test. A miniature screw-type pilot light assembly can be used in the same manner. In this case, the power comes from a filament winding on the set.—*Walter J. Woitowetch*

HANDY SHIELDING MATERIAL

The next time you have to shield a TV or broadcast receiver to prevent the radiation of interference or pick up of shortwave interference, try using Reynolds Wrap or similar metal foil. This material is flexible enough to follow the contours of the cabinet and is tough enough to be worked without tearing.—*N. Schvedman*

INDEXING SYSTEM FOR R-E

My pet peeve is to spend several hours tracking down an article in my files of RADIO-ELECTRONICS and RADIO-CRAFT. I've since lightened this chore by removing the contents pages from all old issues and binding them to a clip board or placing them in a manila folder. Now, when the hunt is on, I find it easier to flip through the index pages than through several stacks of magazines on the bookshelf.—*Albert L. Sohl*

IMPROVING A BAND SWITCH

The RCA Q-10 and similar sets have the band-change switch on the rear of the chassis near one corner. The set owner has to turn the set each time he switches from one band to another. Changing bands is simplified by installing a bar or lever-type knob long enough to project beyond the edge of the cabinet. The same type of knob can be used on receivers which have the phono-radio switch in a corner at the rear of the chassis.—*Miguel Vega Vazquez*

KIT ASSEMBLY HINTS

Experience has taught me that manufacturing tolerances and procurement problems make it advisable to follow these rules when constructing TV sets and other equipment from kits:

1. When controls are mounted on the chassis instead of the panel, mount them for a trial fit. This will enable you to ream the holes and make other adjustments before wiring.

2. Use panel bushings when switches and potentiometers are mounted some distance back of the panel. A rigid shaft makes operation easier and prolongs the life of the component.

3. Capacitors having the same electrical ratings come in many shapes and sizes. Be sure that all parts will fit into the space provided for them before soldering in the first one.

4. Check the color coding and ratings of components against the parts list. Sometimes it is easy to mistake a red dot or stripe for a brown or orange one.

5. Don't dive in as soon as the kit arrives. Read and reread the instructions, then take it easy!—*Eugene Smith*

FOCUS MAGNETS

Focus magnets are used instead of electrodynamic focus coils in a number of TV receivers. Because centering and focusing adjustments vary with different makes and types of magnets, these outline drawings are reprinted from *Tele-Tone Service Bulletin* to assist the service technician in identifying and adjusting each type.

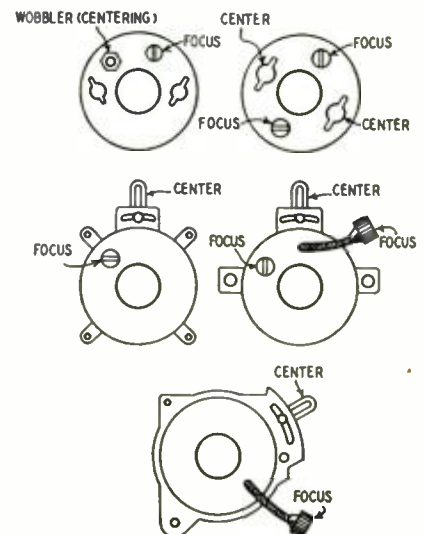

MODIFYING A V-R PICKUP

Output of the G-E variable reluctance pickup can be increased and the possibility of hum pickup reduced by decreasing the spacing between the stylus and the pole pieces.

The poles can be bent toward the stylus with a small pair of pliers or by using two small screwdrivers to apply equal pressure to the sides of both pole pieces. Take care that the tools do not slip and ruin the sapphire point.

Examine the gap with a jeweler's loupe, magnifying glass, or telescope eyepiece having a 2- or 3-inch focal length. The gap should be narrowed until it is barely perceptible on each side of the stylus. It is helpful in judging the width of the gap to move the stylus from side to side while watching the gaps through the glass to see that movement is equal in both directions. The stylus should not strike the pole piece on either side during its maximum vibration. If it does, the distortion will be severe.

After changing the spacing, the value of the pickup's load resistor will probably have to be increased to prevent cutting the highs. Try values between 10,000 and 30,000 ohms and use the lowest value which does not cause noticeable loss of highs.—Homer E. Hogue

(This modification is not recommended for high-fidelity service.—Editor)

SMALL AUDIO CHOKES

Single headphone units sometimes can be substituted for plate chokes in audio circuits. Each 1,000-ohm unit has an approximate load impedance of 5,000 ohms. The diaphragm can be left in place or removed if it makes too much noise. Do not use phones in circuits where they are likely to be overloaded.—Charles Erwin Cohn

THE RADIUM ATOMIC SPINTHARISCOPE



THE SPINTHARISCOPE is one of the most amazing scientific instruments ever invented. The SPINTHARISCOPE demonstrates that radium actually destroys atoms. Look into the SPINTHARISCOPE and you see a whole firmament lit up like a brilliant night sky. You observe thousands of "stars" and untold bright flashes similar to showers of shooting stars. Every flash is the result of the destruction of one atom of radium. These fast moving Helium atoms (also called Alpha rays) produce a minute flash of light when they strike a crystal of zinc sulphide contained in the SPINTHARISCOPE. The magnifying lens of the instrument makes these flashes visible to your eye. The action keeps on going for over 1800 years. Our SPINTHARISCOPE actually contains a small quantity of radium. If you want to see a most awe-inspiring sight, witness the actual destruction of thousands of worlds (atoms are miniature worlds), by simply looking through the lens of the instrument.

See RADIUM DISINTEGRATED AND DESTROYED RIGHT BEFORE YOUR EYES!

The RADIUM SPINTHARISCOPE
Item No. 190

Price, Postpaid 75c

HUDSON SPECIALTIES CO., 40 West Broadway, New York 7, N.Y.

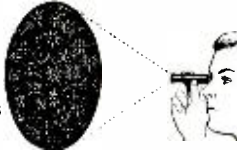

BRINGS IN THE PICTURE!
Bright... Clear and Without Interference

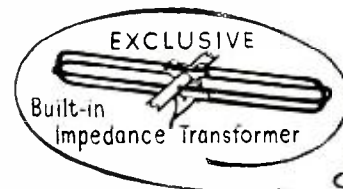

WARD YAGI
Fringe and Super-fringe
ANTENNA

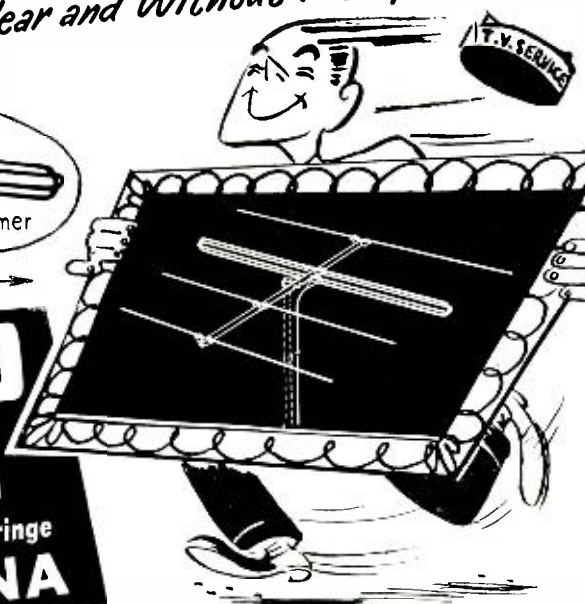

DR. YAGI,
Originator of
Yagi Antenna,
PRAISES
WARD
ENGINEERING

"The low numerical value of Voltage Standing Wave Ratio as recorded is... the proof of the exact matching between circuit elements. In this regard, I highly esteem the excellent ability of your engineers."

Yours very truly,
I/S/Hidetsugu Yagi

WARD YAGIs are producing amazing results! In many cases, acceptable pictures now enthuse set owners, where no image could be obtained by other antennas. Increased sensitivity and exceptionally high gain is developed through Ward's exclusive built-in impedance transformer. Having perfect match to a 300 ohm line, full signal strength is transmitted to the set. Designed with high front to back ratio, a clear, sharp signal is picked up, without co-channel interference. Being closely tuned to each channel, this highly directive antenna has a narrow, angular pattern cutting foreign interference and noise to the minimum.

Ward's Yagi is a highly specialized antenna, designed without compromise specifically for long distance TV reception. In distant areas, and areas intermediate between transmitting centers, where weak signals and co-channel interference obstruct reception, stacking of Ward Yagis enables the selection and maximum energy reception of the desired station.

Order a supply of Ward Yagis today. Satisfied customers make WARD your most profitable antenna.

only WARD OFFERS
TV-FM-AUTOMOTIVE-AM-SPP
ANTENNAS

THE WARD PRODUCTS CORP.
Subsidiary of the Gabriel Co.
1523 East 45th St., Cleveland 3, Ohio

PEN-OSCIL-LITE

Extremely convenient test oscillator for all radio servicing; alignment • Small as a pen • Self powered • Range from 700 cycles audio to over 600 megacycles u.h.f. • Output from zero to 125 v. • Low in cost • Used by Signal Corps • Write for information.

GENERAL TEST EQUIPMENT
38 Argyle Ave. Buffalo 9, N. Y.

When writing to advertisers
please mention
RADIO-ELECTRONICS

500 FORMULAS TO SUCCESS

MANY million dollar firms started with a single formula, for which they paid a big price. Here you have 500—no less—tried and tested formulas, recipes and processes for making things... all at the ridiculously low price of 25c. Here is your opportunity to start a business with but a few dollars' capital and with undreamed of profits in prospect. You can also use these formulas in your own home to cut household expenses to the bone. Or you can put them to use in your workshop to cut costs as much as 100%.



Quit paying out many dollars in profits to manufacturers, wholesalers, and dealers, when you can make the same thing yourself for a few cents. It's so easy when you follow our simple instructions.

66 PAGES. 47,000 WORDS IN TEXT
Send for "500 FORMULAS AND RECIPES" today. Enclose 25c. that's all! You won't be asked for another cent now or later. Sold on a money-back guarantee.

NATIONAL PLANS COMPANY
1966R Broadway, New York 23, N. Y.

YOU CAN STILL

Buy—

TROUBLEPROOF TELEVISION

THE 630 TV WILL WORK WHERE OTHERS FAIL!

- * Own the Television Set preferred by more Radio and Television Engineers than any other TV set ever made!
- * **THE ADVANCED CLASSIC 630 TV CHASSIS.**
- * With the latest 1951 improvements the 630 TV will out-perform all other makes in every way.
- * The 30 plus tube circuit should not be compared to the cheaply designed 24 tube sets now being sold under standard brand names.
- * **Greater Brilliance**
- * Assured by the new 14-16 KV power supply.
- * **Flicker-Free Reception**
- * Assured by the new Keyed AGC circuit—no fading or tearing of the picture due to airplanes, noise or other interference.
- * **Greater Sensitivity**
- * Assured by the new Standard Tuner, which has a pentode RF amplifier and acts like a built-in High Gain Television Booster on all channels!
- * The advanced 630 chassis will operate where most other sets fail, giving good performance in fringe Areas, and in noisy or weak locations.
- * **Larger—Clearer Pictures—for 16", 17", 19" or 20" tubes**
- * Assured by advanced circuits. Sufficient drive is available to easily accommodate any tube.
- * **Trouble-Free Performance**
- * Assured by use of the finest materials such as quality condensers, overrated resistors, RCA designed coils and transformers, etc.
- * **RMA Guarantee**
- * Free replacement of defective parts or tubes within 90 day period. Picture tube guaranteed fully for six months at no extra charge!
- * **PRICE COMPLETE, LESS PICTURE TUBE NET \$164.95**
- * **NO ADDITIONAL TAXES TO PAY**

TELEVISION PICTURE TUBES

Standard Brands

SIX MONTH GUARANTEE

* 12 1/2" (Black or White)...	\$26.50	Glass 16" Round (Black)	\$39.50
* Glass 14" Rectangular (Bik.)	\$29.50	Glass 16" Rectangular (Bik.)	\$39.50
* 17" Rectangular (Bik.)	\$42.50		
* 19" Round (Bik.)	\$69.50		
* 20" Rectangular (Bik.)	\$73.50		

TELEVISION CABINETS

16" or 17" Table Model Cabinet

* A gorgeous table model cabinet for the average size living room. Outside dimensions 23 3/4" Wide x 24" High x 24" Deep.

* Walnut or Mahogany **\$44.50**

16" Economy Console Cabinet

* An exceptional buy in a console cabinet made of fine veneers to house the 630 TV chassis, tube and speaker. Outside dimensions are 39" High x 24" Wide x 22 3/4" Deep.

* **\$49.50**

16" or 17" PERIOD CONSOLE

* Handsomely styled for the conventional living room. Has a drop-door panel to conceal control knobs when desired. Outside dimensions are 41" High x 26" Wide x 24" Deep.

* **\$64.95**

* Above cabinets available for 19" or 20" tubes at \$5.00 additional.

* We are now authorized Distributors for the famous Masco line of high fidelity Amplifiers, Public Address Systems, Tape Recorders, Inter-Communication Systems, etc. Write for latest Catalog.

* All Merchandise Subject to Prior Sale. All Prices Subject to Change without Notice.

WRITE FOR COMPLETE CATALOG C-2

RADIO DEALERS SUPPLY CO.

* 154 Greenwich St. New York 6, New York *

NOVEL RING COUNTER FOR ADDITION OR SUBTRACTION

Patent No. 2,516,146
Thomas A. Prugh, U. S. Army
(may be used by the Government without royalty payments)

This circuit can be used to add or subtract pulses. The upper row of tubes V1 to V4 is a ring counter. As in other counters only one tube in the ring conducts at any time. A negative signal pulse blocks this tube and simultaneously unblocks an

adjacent tube. This positive pulse appears at the grids of V7 and V12. With S in the position shown, V12 has an open plate circuit. Therefore only V7 is affected by the positive pulse. Its cathode output unblocks V2. Successive pulse

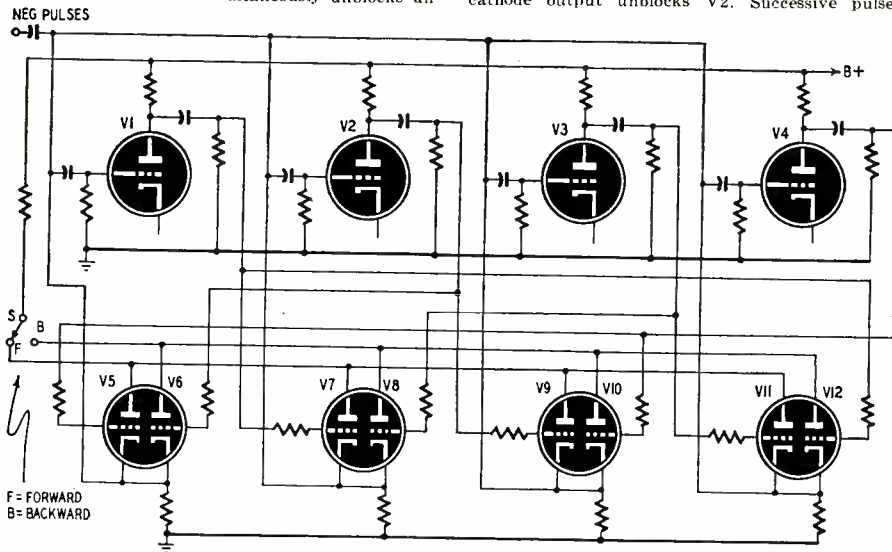

adjacent tube. With this new circuit the unblocked tube may be the next one in either direction. The duo-triodes are control tubes connected as cathode followers. Any signal applied to a grid may be taken from the tube cathode with phase unchanged.

Assume that V1 is originally conducting. A negative pulse blocks it and its plate potential

signals unblock V3, V4, and V1, and the cycle repeats.

When S is thrown to its other contact, the counting direction reverses. The plate circuit of V7 is now open, so with the previous conditions V12 is affected by the first pulse. Output from this tube unblocks V4. Following signal pulses unblock V3, V2, V1, etc.

TWO-WAY INTERCOM SYSTEM PREVENTS FEEDBACK

Patent No. 2,515,726
Angelo Montani, Woodhaven, N.Y.
(Assigned to Automatic Electric Labs, Inc.)

This invention eliminates difficulties due to acoustic feedback. In most intercommunication systems the microphones and speakers must be located close together. The overloading and "singing" caused by energy being fed back around

alternately cuts off one of two triodes at each station. For example, during one half cycle, V1 and V3 are blocked. Therefore M1 and S2 are ineffective while S1 and M2 operate normally. During the next half cycle V2 and V4 are

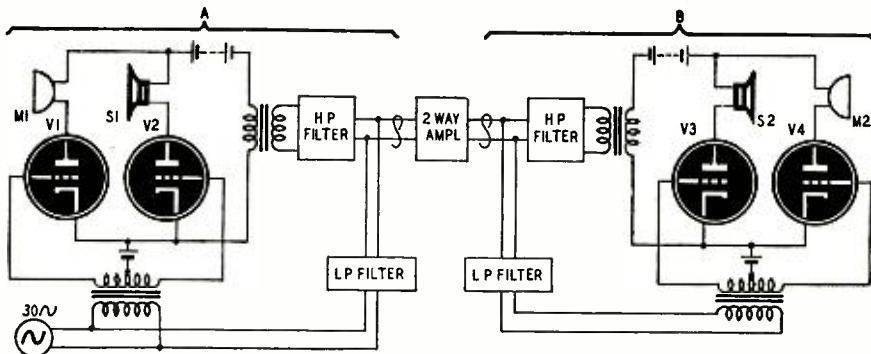

the closed circuit may be prevented by using "speak" and "listen" switches. This is inconvenient and loses time because one party cannot interrupt the other.

Here a low frequency, for example 30 cycles, is used to control microphones and speakers. The figure shows an intercom system connecting two stations A and B. The control frequency

blocked. Therefore only M1 and S2 operate. In each case there can be no "singing" because there is no closed path for the a.f. energy.

Filters separate the a.f. from the lower control frequency at each station but both flow through the same transmission line and amplifier. The low interruption frequency does not affect normal communication.

NEW DRIVER CIRCUIT FOR CLASS-B AMPLIFIERS

Patent No. 2,516,181
Warren B. Bruene, Cedar Rapids, Iowa
(Assigned to Collins Radio Co.)

Class-B grids require a large amount of power during peak signals. This invention uses a novel feedback connection to eliminate the need for large driver tubes to supply this power. It uses a cathode follower driver, which gives the advantage of low impedance in the grid circuit of the final.

First the cathode loads R are chosen for correct value. Then the taps on battery B1 are adjusted for correct bias on the driver grids. Next the class-B grid bias is set by moving the two taps simultaneously in one direction or the other. This adjustment does not disturb the driver bias.

During peak input to the amplifier the grids

of the final take large amounts of power. To satisfy this demand a feedback winding FB is added on the output transformer. When the V2

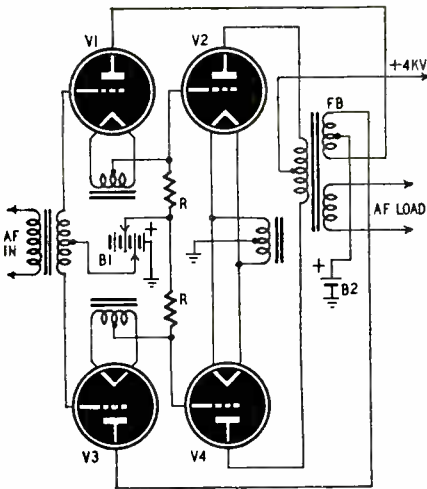

grid goes positive, FB adds to the voltage from B2 and supplies more input to the V1 plate. During the next half cycle FB supplies higher power input to the V3 plate. This provides the additional power from the cathode follower to supply the V4 grid, and so on. During low signal periods only B2 supplies input power to the driver tubes.

TIMING BRIDGE

Patent No. 2,519,247

William H. T. Holden, Woodside, N.Y.

(Assigned to Bell Telephone Laboratories, Inc.)

This circuit accurately measures time intervals by closing relay RY1 at the end of the timed period.

In Fig. 1, capacitor C is discharged through R1. The left triode conducts fully because its

Fig. 1

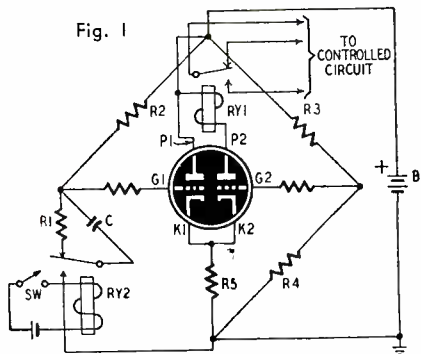

grid G1 returns to the positive terminal of B. The voltage on G2 is fixed by a voltage divider R3, R4. The large current through R5 biases both cathodes and blocks the right triode. Therefore the control relay RY1 remains de-energized.

At some instant T1, switch S may be closed to start the timed period. The armature of RY2 moves down and grounds one terminal of C. At this moment G1 also assumes ground potential. This reduces current in the left triode and permits current in the other triode. At a critical moment T2 the triode currents become equal. Thereafter P1 current drops rapidly to zero while P2 current climbs to maximum. This energizes RY1.

Fig. 2

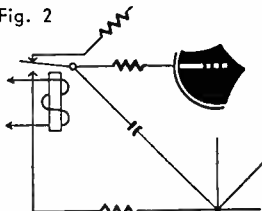

The timed interval may be calculated from the equation

$$T_2 - T_1 = R_2 C \log_e \left[\frac{R_3 + R_4}{R_4} \right]$$

Modify the circuit as in Fig. 2 to open RY1 at time T2.

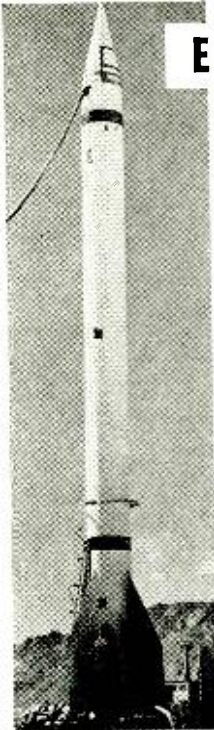

Whether you're in the Armed Services or in Industry
ELECTRONICS TRAINING PAYS OFF
WITH INTERESTING JOBS AND HIGHER EARNINGS

CREI Residence School training offers quick promotion in uniform as well as profitable civilian careers

IN or out of the armed services, the best jobs go to the men with technical training. If you are prepared with electronics training, you're fortified for the future, whether you're headed for a berth in the armed services or a career in essential industry. Because of the critical shortages that exist today in the electronics industry, the qualified technicians and engineers can practically choose their own futures. Because of the dependence of modern armies, navies, and air forces upon electronics—for radar, communications, and navigation—the man with even limited knowledge of electronics gets ahead quickly in uniform. In case you're called to active duty before completion of your CREI course, you'll still be way ahead, for the armed services will choose you for further electronics training in place of the completely un-trained man.

At CREI you'll work with the latest equipment—over 120,000 square feet of modern class rooms, TV and radio broadcasting studios, transmitters, control rooms, and experimental labs. Here you're grounded in the fundamentals required for work in guided missiles, TV, and all the other important fields of communications and electronics. CREI's experience in training thousands of men for the Army, Navy and Coast Guard in World War II, coupled with pioneering background in technical education and close industry connections, assure you of the best in technical preparation. To insure your training ACT RIGHT NOW. Send today for free Residence School catalog.

FOR FREE CATALOG, MAIL COUPON NOW!

APPROVED FOR VETERANS — New classes start twice a month. High level home study training also available for professional radio men.

CAPITOL RADIO ENGINEERING INSTITUTE
16th Street and Park Road
Dept. 302C Wash. 10, D. C.

CREI—16th & Park Rd., Washington 10, D. C.

Please send free Residence School Catalog.

Name.....

Street.....

City..... Zone..... State.....

Veteran..... Non-Veteran..... Age.....

Send details about Home Study Courses 302C

TECH-MASTER TELEVISION

New TECH-MASTER developments!

LO-PRICED
Universal KIT



FOR TUBES UP TO 14" RECT.

First LOW-COST TV Receiver Kit completely engineered by TECH-MASTER. Features 2-knob control and small, lightweight chassis.

Model 5016
Resale Price \$89.50

Advanced
630 Type KIT



FOR ALL TUBES 12" Rd. to 20" Rect.

The greatest advance in TV—developed by top TECH-MASTER engineering!

Model 630D19 (De-Luxe) Principal components assembled.
Resale Price \$159.50
Model 630S19 (Standard) Unassembled.
Resale Price \$154.50

All 3 Kits supplied with all tubes (less Kine), parts, speaker and six tube mounting brackets.

CONTACT YOUR JOBBER or write Dept. RC-2 for literature.

TECH-MASTER PRODUCTS CO.
443-445 Broadway, New York 13, N. Y.

More leading engineers and technicians have built Tech-Master for their own use than any other Television Kit.



QUAM Adjust-A-Cone SPEAKERS

15-inch Coaxial

FIRST IN
REPLACEMENT
FIELD

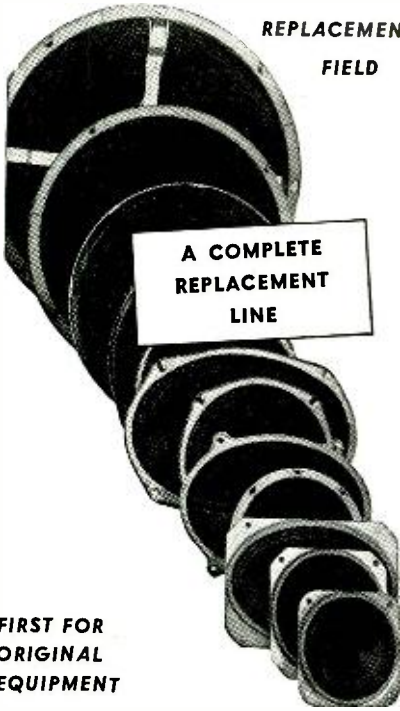

FIRST FOR
ORIGINAL
EQUIPMENT

3-INCH

With P.M. and Dynamic Speakers from a 3" model to a 15" coaxial speaker, there isn't a radio set built today that cannot be fitted with a Quam Adjust-A-Cone Speaker. And every one is designed for the superior, trouble-free performance that means customer satisfaction and more profitable business for you.

And remember, every Quam Speaker has the exclusive U-Shaped Coil Pot that increases speaker efficiency, plus the patented Adjust-A-Cone construction that makes a rubbing voice coil as rare as a Sahara snowball.

For customer satisfaction, it pays to "Replace with Quam."

Write for Complete Quam Catalog
Also makers of Quam Focalizer Unit
and ION TRAPS

QUAM-NICHOLS COMPANY

521 E. 33rd Place CHICAGO 16, ILLINOIS

MAKERS OF QUALITY SPEAKERS FOR 27 YEARS, UNDER THE SAME MANAGEMENT

LET US PUT THIS MAGNIFICENT NEW 1951 19 1/2-INCH MIDWEST TELEVISION-RADIO-PHONO CONSOLE IN YOUR HOME ON 30 DAYS MONEY BACK TRIAL

EASY TERMS

Don't buy any radio or television receiver until you've seen the new 1951 Midwest Line — it's the finest in 31 years

FACTORY-TO-YOU

MIDWEST RADIO & TELEVISION CORP.
Dept. 38-H, 909 Broadway, Cincinnati 2, Ohio

SEND THIS COUPON ON 1c POST CARD FOR NEW 1951 FREE 4 COLOR MIDWEST CATALOG

NAME _____
ADDRESS _____
CITY _____ ZONE _____ STATE _____

FREQUENCY STANDARD HAS HIGH R.F. ACCURACY

Described in *G-E Ham Tips*, this interpolation-type frequency meter permits r.f. signals to be measured within a few cycles. The first 6AK5 is a Clapp oscillator tunable from approximately 100 to 101 kc. This range of 1,000 cycles is covered with a good vernier dial calibrated from 0 to 100. A National type N dial with a No. 2 scale was used on the original model. When the oscillator's range is exactly 1,000 cycles, its frequency can be read to one cycle. The next stage is a 6AK5 blocking-tube oscillator which divides by 10 the frequency of the variable oscillator.

Coils L1 and L3 are critical. You can avoid experimenting if L1 is a Millen 8-mh choke type No. 34208 and L3 is a center-tapped 10-mh choke No. 34210-1. L2 may be the same type as L1. C1, the tuning capacitor, is a 12- μ f double-spaced variable (Millen type 23915A with one stator plate removed).

end of the scale. When the oscillator's frequency is exactly 101.01 kc, its 99th harmonic will beat with WWV on 10 mc. Note the dial reading for this 1,010-cycle variation. Divide 1,010 by the dial reading to get the number of cycles per dial division. The dial calibration will be linear because of the small range covered.

Use steel wool to clean the pins of the 6AK5 blocking oscillator, then plug it in. Set the tuning dial to zero, tune in the signal at a fairly low frequency and turn on the set's b.f.o. Adjust the 10,000-ohm control so there is a beat every 10 kc between a successive pair of 100-kc signals. If the intermediate beats are not clear and regular, connect a coupling capacitor between the oscillator as shown by the dashed lines. Start with 5 μ f and experiment until the beats are regular. If more than 10 μ f is needed, vary the value of the 750,000-ohm grid resistor or the 75,000-ohm resistor in the voltage divider cir-

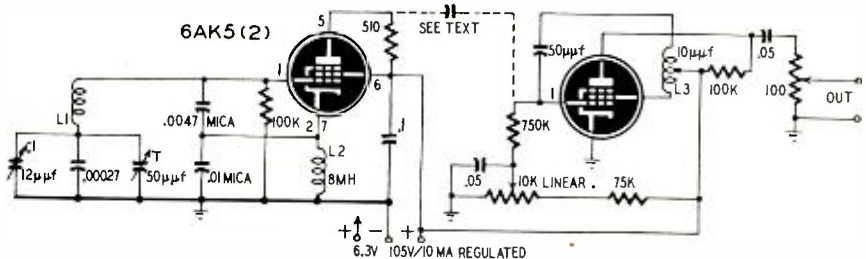

Let the unit warm up for 10 or 15 minutes and remove the blocking-tube oscillator (b.t.o.) from its socket. Set the tuning dial to zero and check the frequency against WWV on 5 mc. Zero-beat the two signals with the 50- μ f trimmer. Now beat the 100th harmonic against WWV on 10 mc. You may have to run the antenna lead close to the oscillator plate for sufficient pickup. Note well that the tuning dial should be at zero for zero beat with WWV on both frequencies. Turn the tuning dial until another beat is heard at the other

cuit. These resistors are available only in 5% tolerances in RMA preferred values. It may be worth while to experiment with 68,000- and 82,000-ohm units in place of the 75,000-ohm unit, and 680,000- and 820,000-ohm units in place of the 750,000-ohm resistor.

The instrument is easy to operate. Assume that an unknown signal is somewhere between 3990 and 4000 kc. When the dial of the standard is at zero, the 39th harmonic of the variable oscillator is at 3900 and the 399th harmonic of the b.t.o. is at 3990. Rotate the dial until the 3990 beat moves up to zero-beat with the unknown signal. Note the dial reading. If the dial has moved seven divisions and there are 12.5 cycles per division, the variable oscillator has shifted 87.5 cycles and the b.t.o. has shifted from 10 to 10.00875 kc. Its 399th harmonic—and the frequency of the unknown signal—is 3,993.491 kc. As a double check, continue tuning the standard until the 398th harmonic beats with the unknown signal. The b.t.o. now operates at 10.033875 kc and its 398th harmonic is at 3993.482 kc—only nine cycles off the first reading. Average these readings for the final results. The short-term accuracy of this standard is approximately 40 cycles at 4 mc. This accuracy can probably be maintained by checking the variable oscillator against WWV before making a reading.

Because of the small power requirements of this instrument, the plate and filament power can usually be taken directly from a receiver. An 0C3/VR-105 makes an excellent source of B-plus.

TWIN-TRAX* TAPE RECORDERS

... give you more

MORE MODELS
the most complete variety of recorders for professional, semi-professional and experimenter use.

MORE FEATURES
for better quality, smoother performance and easier operation.

MORE VALUE
because our direct sales policy saves you dealer markups.

Send today for our catalog 5109 which lists complete technical specifications and performance ratings for all recorder models and accessories. *Trademark Reg.

AMPLIFIER CORP. OF AMERICA
398 Broadway New York 13, N. Y.

OPTIMUM SCREEN VOLTAGE

When a pentode is operated in a resistance-coupled amplifier, the screen-grid voltage which will produce maximum gain is critical. When the screen voltage is below the optimum value, the tube transconductance and gain drop off rapidly. An increase in screen voltage produces an increase in plate current. The I-R drop across the plate load resistor R3 reduces the d.c. voltage on the plate and decreases the output. In practice, I have found that the reduction in gain is quite marked, amounting practically to complete plate-current cutoff.

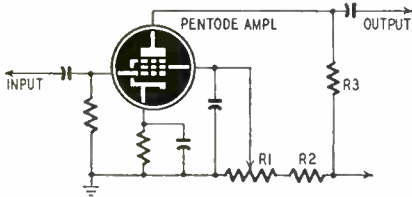

When developing an a.f. amplifier, I use the experimental setup shown in the diagram. The screen grid is connected to the arm of a potentiometer R1 connected between B-plus and ground. The control is adjusted for maximum gain and the screen voltage is measured. The potentiometer is then replaced with a series dropping resistor or voltage divider which will supply the screen with the desired voltage.

Some detector circuits have a variable control in the screen-grid circuit with a fixed resistor R2 to limit the maximum screen voltage. If, in the operation of such circuits, the gain continues to increase as the control is advanced to the end of its range, remove R2 or reduce its value until the optimum screen voltage is within the range of the variable control.

When the pentode is a voltage amplifier ahead of a class B or AB amplifier, check its supply voltages under operating conditions. The peak current drawn by the output stage may drop the supply voltage to the point where the pentode overloads or clips and causes distortion. If the supply voltage varies, check the rectifier, filter capacitors, and bleeder resistor. If all are O.K., feed the pentode and other voltage amplifiers from a decoupling filter having a large capacitor.—Charles Erwin Cohn

EMERGENCY PA HOOKUP

On an emergency PA installation, it became necessary to feed two amplifiers from a single microphone. No mixer panel being available, the input of one amplifier was connected across



the output of the other through blocking capacitors connected as shown in the diagram.

The voltage across the low-impedance speakers averages a volt or two. After passing through the capacitors, it is equal approximately to the output of a good crystal pickup.—Robert C. Greene



BUILT TO TAKE IT

... BUT the goalie is not expected to join the play in center ice. He is physically conditioned and equipped for one job — to "stay put and take it". It's different with a Thomas picture tube . . .

For a Thomas tube is a flashing performer as well — it produces finely shaded contrasts and clear, steady pictures which make it the all-season star of hundreds of thousands of TV receivers.

Getting a Thomas tube means getting all the endurance and staying power, and all the top-flight performance which are built into the Thomas product.

So, see that your customers get the best — recommend a Thomas picture tube!

THOMAS ELECTRONICS, Inc. 118 Ninth Street Passaic, New Jersey

Over 43,000 Technicians Have Learned **HOW TO GET THE MOST OUT OF BASIC TEST EQUIPMENT** Why Not You, Too?

SERVICING by SIGNAL SUBSTITUTION
A BEST SELLER FOR OVER 9 YEARS! (NEW, UP-TO-DATE, 11TH EDITION)

The Simple, Modern, Dynamic Speed Approach To Receiver Adjustment and Alignment Problems, AM-FM-TV.

- Nothing complex to learn
- Universal — non-obsolete
- No extra equipment to purchase
- Employs Only Basic Test Equipment

only **40¢**

100 pages. Invaluable information that will help you re-double the value of your basic test equipment.

Ask for "S.S.S." at your local Radio Parts Jobber or order direct from factory.

PRECISION APPARATUS COMPANY, INC. • 92-27 Horace Harding Blvd., Elmhurst 4, N. Y.

PERFECT FOR FRINGE AREA RECEPTION
30 TUBE 630 CHASSIS LICENSED By RCA
 ADAPTABLE FOR COLOR
THE IDEAL CHASSIS FOR 16"-17"-19"-20" PICTURE TUBES
A SET
 MOUNTING BRACKETS FOR TUBE \$350
RMA & AIREX
 Guarantee
 Factory wired, aligned & tested.

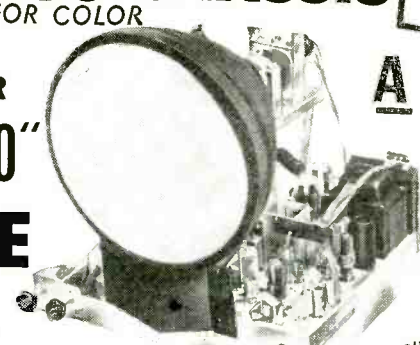

\$159.95
 Without Cathode Tube
 With Standard Coil Tuner
 and Speaker

Thousands of our 16", 17", 19" & 20" sets are giving new viewing thrills to TV watchers all over the country. This extra powerful super chassis is designed to bring in sharp, clear pictures, even in fringe areas. Works in most areas on only an indoor antenna. Has Improved Keyed AGC; Full 4 Megacycle Band Width; 16 KV output; 3 stage SYNC Separator & clipper; Moulded Plastic Condensers; Uses new Mark Transformer; 5-hour Min. Heat Run at Factory; Improved high gain front end, down to 45 microvolts; Synchro Lock; Freedom from arcing & corona leakage; Armstrong FM Sound System; Improved linearity adjustment & second horizontal linearity control.

AVAILABLE with DUMONT INPUTUNER FM RADIO & SPEAKER **\$169.95**

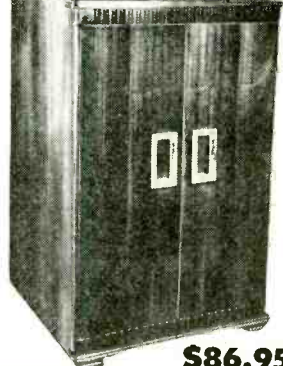

A PRICE-SMASHING VALUE IN TV CABINETS FOR THE 630 CHASSIS
 Full Doors for 16"-17"-19"-20" Picture Tubes
 Without Doors for All Picture Tubes

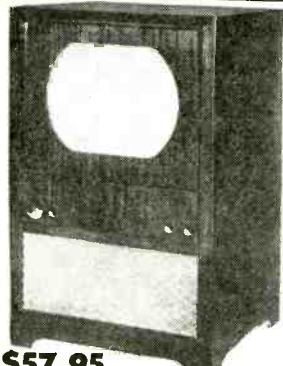

Beautiful, richly finished, hand rubbed mahogany cabinets specially designed to house the 630 chassis with a 12" speaker. A perfect picture deserves a perfect cabinet. It will be a focal point of beauty in your home. 40" high x 21" x 24". All complete with brackets, mask & hardware. Above cabinets in blond—\$10 EXTRA.

\$86.95

\$57.95

REGENCY BOOSTERS—DB 400—\$19.97 12" Wide Range RCA Speaker, \$4.95

TV TUBE SCOOP
 All Black, Glareless
 Dumont, Sheldon, Zetka, TRL
 16" Rect or Round... \$42.50
 17" Rectangular... 46.95
 19" Round... 69.95
 20" Rectangular... 74.95
 All Tubes Fully Guaranteed for 6 Months
 Plastic ring and sleeve for metal tubes... \$4.95

RECORD CHANGER SALE
 SAVE UP TO 65%
\$12.95 PHILCO Automatic Record Changer 78 RPM. Permanent point needle. Universal mounting. Plays 10-12" or 12-10" records automatically. Reg. \$39.50
\$29.95 WEBSTER 3-SPEED CHANGER Plays 12 records automatically. All sizes. All speeds. 33 1/3-45-78 RPM. Permanent point needle. In original case. Reg. \$48.00



All merchandise is brand new, factory fresh & fully guaranteed. Mail & phone orders filled upon receipt of certified check or money order for \$25 as deposit on TV chassis. 20% on other items. Balance C.O.D., F.O.B., N. Y. Prices subject to change without notice.

AIREX RADIO CORP. 171 WASHINGTON ST., N. Y. C. 7, N. Y. Worth 2-4029; Worth 2-9578

COAXIAL ANTENNA PLUGS

Care in soldering the antenna plug to coaxial cables will minimize service call-backs and signal losses. First remove the vinyl jacket, copper braid, and polyethylene insulation as shown at *a*. Be careful not to nick the braid or center conductor. Solder the connec-

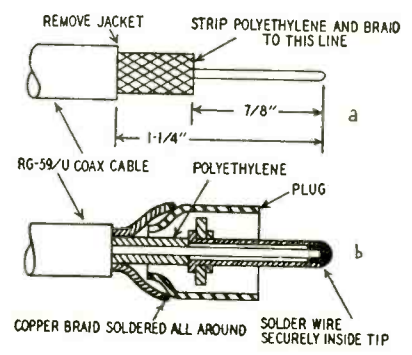

tions as shown at *b*. Line up the cable with the body of the plug, then use a hot iron for soldering. Work rapidly to avoid excessive heat which will damage the polyethylene insulation and increase leakage and possibility of short circuit between the conductors. Check the plug for shorts with an ohmmeter.
 —Du Mont Service Note

RCA VICTOR 86T

The set came in with a noisy volume control. It played perfectly for a few days after the control was replaced, then had to be returned to the shop with the same complaint. The control was removed and checked with an ohmmeter and by installing it in another receiver. It was perfect on both counts, so it was reinstalled in the set. The trouble was finally traced to the 0.25-uf bypass capacitor between the bottom end of the control and ground. This capacitor was intermittent and leaky. The trouble cleared up permanently when the capacitor was replaced with a new one.—W. Snajberk

CHECKING DEAD RECEIVERS

A tuneable signal tracer is handy for checking the performance of the pre-selector and oscillator of a dead receiver. Tune the receiver to the frequency of a strong local station, then tune the signal tracer to the receiver's intermediate frequency. If the front end is O.K., the station will be heard from the tracer when its r.f. probe is brought near the oscillator tube or chassis.

If you are not sure of the receiver's i.f., tune the tracer between 115 and 500 kc until the signal comes through.
 —R. Lambert

ZENITH 5R086E

The complaint was a heavy hum on some stations. Because the tuning gang was above ground in this model, we suspected that there was a high-resistance short through the rubber grommets. The trouble was eventually traced to the dial pointer. It was touching the dial, which was cardboard sprayed with metallic paint. Bending the pointer away from the dial ended the trouble.—Jack Shino

NEW CONDENSER TESTER
Finds Intermittent Condensers Instantly
 Pres-probe's sliding tip with variable resistance prevents condenser heating. Tests with power on. Requires no adjustment. Stops guesswork. Saves time. Convenient probe size (7/8" long). Satisfaction guaranteed.
795 Postpaid U.S.A.
 See Your Dist. or Order Direct
PRES-PROBE CO.
 2326 N. THIRD ST., MILWAUKEE 12, WIS.



EASY TO LEARN CODE
 It is easy to learn or increase speed with an Instructograph Code Teacher. Affords the quickest and most practical method yet developed. For beginners or advanced students. Available tapes from beginner's alphabet to topical messages on all subjects. Speed range 5 to 40 WPM. Always ready—no QRM.
ENDORSED BY THOUSANDS!
 The Instructograph Code Teacher literally takes the place of an operator-instructor and enables anyone to learn and master code without further assistance. Thousands of successful operators have "acquired the code" with the Instructograph System. Write today for convenient rental and purchase plans.
INSTRUCTOGRAPH COMPANY
 4701 Sheridan Rd., Dept. RC, Chicago 40, Ill.

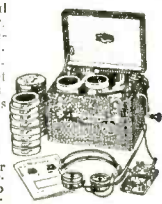

7 HARD TO GET ITEMS AT BIG SAVINGS TO YOU

AMAZING BLACK LIGHT



250-watt ultra-violet light source. Makes fluorescent articles glow in the dark. Fits any lamp socket. For experimenting, entertaining, unusual lighting effects. Ship. wt. 2 lbs. ITEM NO. 87 A SAVING AT **\$2.45**

LITTLE GIANT MAGNET

Lightweight 4 oz. ALNICO permanent magnet. 1 3/4" x 1 1/2". Lifts more than 20 TIMES ITS OWN WEIGHT! Ideal for hobbyists, experimenters. Shipping weight 3/4 lbs.



ITEM NO. 159 BIG VALUE AT

\$1.50

POWERFUL ALL PURPOSE MOTOR

Sturdy shaded pole A.C. induction motor. 15 watts, 3000 rpm. 3"x2"x1 1/4". 4 mounting studs; 7/8" shaft, 3/16" diameter; 110-120 volts. 50-60 cycles. A.C. only. When geared down, this unit can operate an 18" turntable with a 200 lb. dead weight. Use it for fans, displays, timers and many other practical purposes. Ship. wt. 2 lbs.

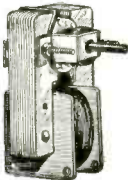

ITEM NO. 147 UNUSUAL BUY **\$2.45**

WATTHOUR METER

Leading makes — completely overhauled, ready for service. 100-110 volts, 60 cycles, 2-wire A.C. 5 amp. Heavy metal case 8 1/2" x 6 1/4" x 5". Easy to install. Shipping weight 14 lbs.



ITEM NO. 33 NOW ONLY

\$4.50

WESTERN ELECTRIC BREAST MIKE

Lightweight 1 lb. carbon microphone. Aircraft type. Breastplate mounting, adjustable 2-way swivel. Easily fastened straps. For home broadcasts, communications etc. Complete with 6 foot cord, hard rubber plug. Spherized plate, non-rusting finish. Ship. wt. 2 lbs.



ITEM NO. 152 NEW LOW PRICE **\$1.10**

TELEPHONE TRANSMITTERS

Genuine transmitters made by Kellogg, Western Electric, Stromberg Carlson. Work on two dry cells. For P.A. systems, intercoms, other practical uses. Shipping weight 1 lb.



ITEM 160 REAL VALUE **\$2.45**

250 POWER TELESCOPE LENS KIT

Make your own high powered 6 ft. telescope. Kit contains 3" diam., 75" focal length, ground and polished objective lens and necessary eye pieces. Magnifies 50x to 250x. Full instructions. Ship. wt. 1 lb.



ITEM NO. 123 YOU SAVE AT **\$2.95**

HUDSON SPECIALTIES CO.
40 West Broadway, Dept. RE-2-51
New York 7, N. Y.

I am enclosing full remittance for items circled below. Shipping charges included.

OR, my deposit of \$..... Ship balance C.O.D. MINIMUM C.O.D. ORDER \$5.00. C.O.D. ORDERS ACCEPTED ONLY WITH 20% DEPOSIT INCLUDE SHIPPING CHARGES.

Circle items wanted
87 159 147 33 152 160 123

Name..... Please Print Clearly

Address.....

City..... Zone..... State.....

LOW VOLUME AND DISTORTION

Low volume, noise, and distortion in the Westinghouse H-126 and Zenith Nash AC-4389 are commonly caused by leaky decoupling capacitors in the audio circuits. Fig. 1 shows the circuit

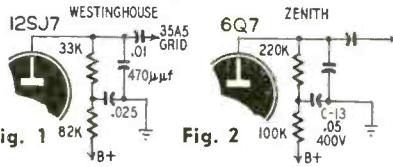

Fig. 1 82K in the Westinghouse receiver and Fig. 2 shows the source of trouble in the Zenith sets made for Nash automobiles. —T. Horiuchi

ODD CAUSE OF FADING

A small a.c.-d.c. set came in with a complaint of severe intermittent fading. It was actually shifting frequency to the extent that the station was lost and could be tuned in at another setting on the dial. In a few moments, the signal would drop out again and return to its original frequency. Adjusting padders and trimmers did not cure the trouble.

We noticed that the input filter capacitor had gone bad in the past and had been shunted with a good one—a bad practice but a common one. Clipping the lead off the old capacitor cured the frequency shifting and the set worked normally.

The old capacitor was probably charging for short periods, thus increasing the B-voltage and causing the oscillator to shift frequency. When the capacitor lost its charge, either through an increase in temperature or an open circuit, the voltage and tuning returned to normal.

HALLICRAFTERS T-54 and 505

When the set was first turned on, the raster would start to form only to disappear after filling half the screen. A sharp click could be heard as the raster disappeared. This action would continue in cycles.

The trouble was caused by arcing between the two high-voltage leads going to the focus control. Separating the leads and covering one of them with a length of high-voltage spaghetti tubing cleared up the trouble. —Peter J. Foradas.

RCA MODELS 56X2 AND 56X10

If these sets come in with a complaint that the audio is muffled, choked up, or distorted, look for a defective volume control. The carbon element has flaked off in the controls in several of these models. Replace the control with a reliable 500,000-ohm unit. —Leon Beckerman

MOTOROLA TS-9D, TS-15B

If no high voltage is present in these and similar models, pull the 6AL5 phase detector tube. If high voltage returns without horizontal sync, replace the .05µF, 600-volt capacitor (connected to pins 6 and 7 of the 6AL5) with one having a higher voltage rating. If a positive voltage can be measured at pins 5 or 7 of the 6AL5, it indicates that the capacitor has shorted and must be replaced. —Yuki Minaga

"NO BOOK

in two generations, no book since Jules Verne, has undertaken to do what Hugo Gernsback in the first decade of our century has here so outstandingly achieved."

LEE DE FOREST
Father of Radio



Forty years ago, Hugo Gernsback, Father of Modern Science Fiction, in this book, **RALPH 124C 41+**, predicted and described in startling detail, radar, the learn while you sleep method, television, televised operas, plastics, night baseball, blood transfusion, wire recording, micro film and a host of other scientific achievements—all undreamed of in 1911—but part of everyday life today.

All of these and scores more, not as yet realized, are found in his remarkable prophetic book. For Hugo Gernsback's prophecies are based not on fantasy but on the logical projections of established scientific facts.

RALPH 124C 41+ is the first and most remarkable true science fiction novel ever written! A whacking good adventure story that takes place in 2660 AD—but it is far more than fiction!

To technically minded people, **RALPH 124C 41+** is the most complete and accurately documented catalog of scientific prophecy ever published. It was originally written in 1911 and published in book form in 1925. Now, because of its tremendous importance as a work of accurate, scientific prediction of the future, it has been reissued in a new, second edition.

Hugo Gernsback's writings were the spark that started many of today's top radio engineers and scientists on their way. Now again, this new edition of **RALPH 124C 41+** may well be the inspiration for a new generation of pioneers of science.

RALPH 124C 41+ is the kind of book you should read. Order your copy now, only \$2.50 postpaid. The supply is limited.

RADIO PUBLICATIONS

25 West Broadway New York 7, N. Y.

MAIL THIS COUPON TODAY

RADIO PUBLICATIONS

25 West Broadway, New York 7, N. Y.

Gentlemen:

Send me a copy of **RALPH 124C 41+** postpaid, at once. My remittance of \$2.50 is enclosed.

NAME.....

STREET.....

CITY..... ZONE..... STATE.....

*Best Technical Book
Buy in the Field
To-day!*

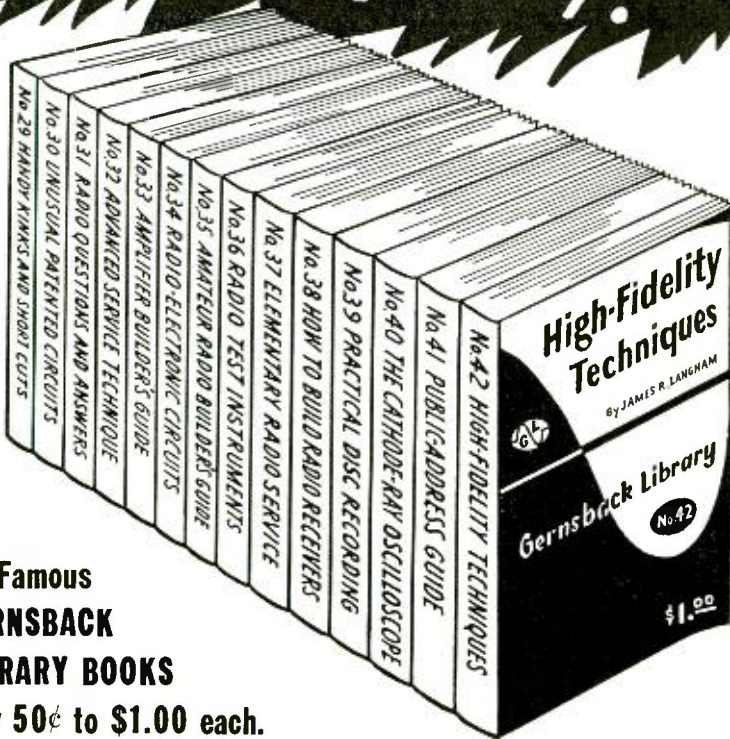

**14 Famous
GERNSBACK
LIBRARY BOOKS**
only 50¢ to \$1.00 each.

No other books give you so much on Radio and Audio at anywhere near these low prices! Beginner or expert, you'll find GERNSBACK LIBRARY BOOKS that you want. Servicing, Construction or Theory—there's at least one book on each phase! Written by top technical authors in a simple, accurate style which gives you the "meat" of every subject. Fully illustrated with photos and diagrams! Check the list of titles below—and order the books you want today.

A COMPLETELY "DIFFERENT" BOOK ON HIGH-FIDELITY

No. 42—HIGH-FIDELITY TECHNIQUES—by James R. Langham. 112 pages \$1.00

THREE IMPORTANT 75¢ BOOKS

- No. 39—PRACTICAL DISC RECORDING—96 pages
- No. 40—THE CATHODE-RAY OSCILLOSCOPE—112 pages
- No. 41—PUBLIC-ADDRESS GUIDE—80 pages

TEN 64-PAGE BOOKS—BIG VALUES AT 50¢ EACH

- | | |
|------------------------------------|--------------------------------------|
| No. 29—Handy Kinks and Short Cuts | No. 34—Radio-Electronic Circuits |
| No. 30—Unusual Patented Circuits | No. 35—Amateur Radio Builder's Guide |
| No. 31—Radio Questions and Answers | No. 36—Radio Test Instruments |
| No. 32—Advanced Service Technique | No. 37—Elementary Radio Service |
| No. 33—Amplifier Builder's Guide | No. 38—How to Build Radio Receivers |

**See Page 102
for an important
new book
announcement**

See Your Distributor—or use coupon
RADCRAFT PUBLICATIONS, INC.

RADCRAFT PUBLICATIONS, INC., DEPT. 21
25 West Broadway, N.Y., N.Y.

Enclosed is \$..... for books checked

- 29 30 31 32 33 34 35
 36 37 38 39 40 41 42

NAME

ADDRESS

CITY..... STATE.....

**HELP-FREDDIE-WALK FUND
FUND REACHES \$6145**

We are proud and pleased to announce that with this issue the *Help-Freddie-Walk-Fund* has reached \$6145.

Your Editor wishes to congratulate our readers for the very generous contributions which were made before last Christmas to help rehabilitate two-year old Freddie Thomason, the young son of the Arkansas radio technician, who was born both armless and legless.

RADIO-ELECTRONICS' readers have come to Freddie's assistance with vim and vigor and they seem to be determined to make a real radioman of little Freddie, a most intelligent youngster who should go far in his profession once he learns how to walk and use his future arms to become a useful citizen.

We must also report the following most unusual occurrence:

Last month a stranger walked into our office and laid down before our astonished eyes eleven \$100 bills, a total of \$1100. We had never seen him before, a mild mannered middle-aged gentleman, whose hobby is technical reading and who insisted on remaining anonymous. All he would tell us was, "I am an old bachelor and I feel that Freddie needs the money much more than I do. So, I thought I would contribute to this worthwhile fund." A very generous and magnificent contribution, which we are certain all of our readers will applaud.

Another sizable contribution of \$664.17 was made by employees of the Allen B. Du Mont Laboratories, Inc. The Du Mont Television people have a house organ called the RASTER. Recently they ran a story on the Help-Freddie-Walk-Fund with Freddie's picture, which RADIO-ELECTRONICS supplied. Much to their own, as well as our surprise the Du Mont employees contributed very handsomely. In little Freddie's name we wish to shake the hands of all the employees in making this generous contribution possible.

We wish to also thank the following organizations, all of which were kind enough to make collections for the *Freddie* fund as follows:

\$15.00 tendered by William C. Walters for a number of good-hearted Atlanta (Ga.) Radio and Teletype Workers.

\$45.45 donated by Harry L. Rupp for the following departments of Douglas Aircraft Co., Long Beach (Cal.) Plant: Depts. 596, 283, 312, 315, 318, and Misc.

\$14.00 by Roy L. Sheridan, Treasurer, for the Everyman's Bible Class of Petworth (Wash., D.C.) Methodist Church.

\$55.00 contributed by Graham E. Moore for A Group of Electronics Men of Collinsville, Ill., whom Mr. Moore represented.

\$14.00 tendered by the Morning Class of Veterans' Radio School, Office Personnel of Johnstown (Pa.) High School for Veterans.

\$25.00 collected by Herbert H. Johl, Treasurer, for the Kappa Gamma Phi Fraternity of the Milwaukee (Wis.) School of Engineering.

\$35.00 donated by the National Advisory Committee for A onautics of

ONLY — RADIO-ELECTRONICS

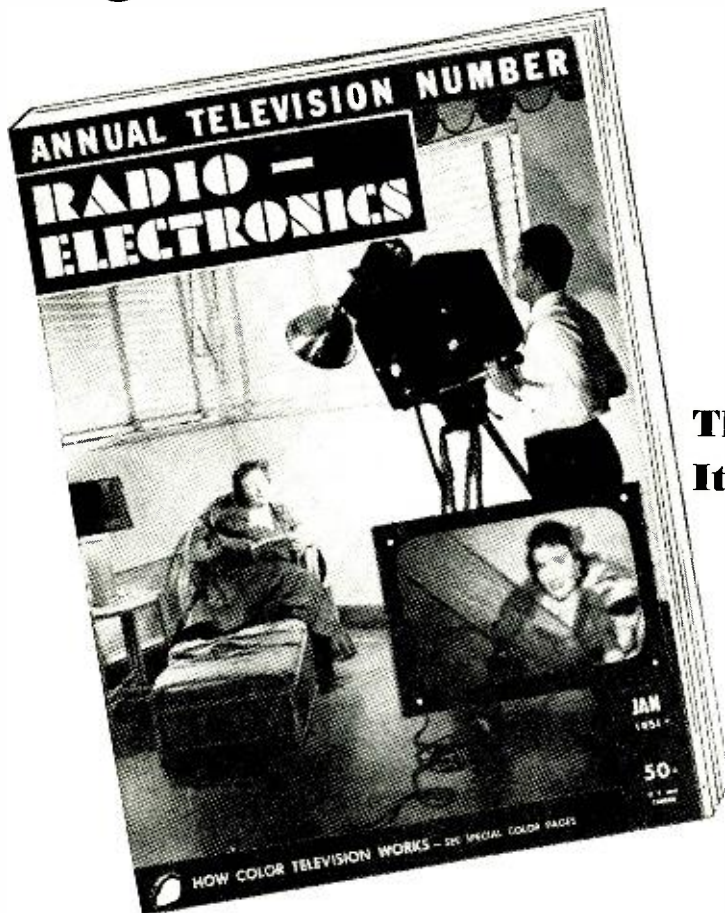

Gives You Such Complete Coverage On

RADIO TELEVISION AUDIO

**This Month—and Every Month—
It Offers Important Articles on**

- Servicing
- Installation
- Theory
- Construction
- Operation
- New Developments
- Amateur

PLUS A TREASURY OF CIRCUITS.
CHARTS AND SCHEMATICS.

DON'T MISS A SINGLE ISSUE
SUBSCRIBE NOW
— and Save!

RADIO-ELECTRONICS is the fastest growing magazine in radio, television and audio. More and more readers all over the world like its fresh approach and lively style. Make sure you get your copy every month. Subscribe for an extended period, today.

SUBSCRIPTION RATES

THREE YEARS	\$8.00
TWO YEARS	\$6.00
ONE YEAR	\$3.50

*Canada, Mexico, South and Central
America same as U.S.A. All other
foreign \$1.00 extra for each year.*

**RADIO —
ELECTRONICS**

25 West Broadway

New York 7, N.Y.

These Men are Getting PRACTICAL TRAINING



IN TELEVISION-RADIO ON REAL TELEVISION SETS RADIO RECEIVERS F.M. RECEIVERS IN THE GREAT SHOPS OF COYNE

Big opportunities are waiting for men who know the practical and technical end of Television and Radio. That's what you get at COYNE—besides practical Shop Training in F.M., Electronics and other branches of this giant field. Remember, Television is the fastest growing opportunity field today, and Radio is one of the biggest.

NOT "HOME STUDY" COURSES

All Coyne Training is given in our mammoth Chicago training shops. We do not teach by mail. You train on actual equipment, under friendly instructors. Previous experience unnecessary. Hundreds of firms employ Coyne trained men.

START NOW—PAY LATER

Come to the Great Shops of Coyne in Chicago. Established 1899—now in our 52nd Year. Oldest, largest, best equipped school of its kind in America. Fully approved for G.I. training. Finance plan for non-veterans.

MAIL COUPON FOR FREE BOOK

Send today for big new book packed with large pictures taken in Coyne Shops. No obligation. No salesman will call. Get the facts now!



COYNE
Electrical & Television-Radio School
An Institution not for Profit
500 S. Paulina St., Chicago 12
Dept. 21-8H

B. W. COOKE, Pres.
COYNE Electrical & Television-Radio School,
500 S. Paulina Street, Dept. 21-8H, Chicago 12, Ill.

Send FREE BOOK and full details on Television-Radio Course.

NAME.....
ADDRESS.....
CITY.....STATE.....

the Electronic Instrument Construction Shop of Langley Field, Va.

\$5.00 by L. O. Mahan, Secretary, for the Newport (R. I.) County Radio Club.

\$15.00 by Frederick B. Temple, Student Council Treasurer, on behalf of the Student Body of the Residence School, Capitol Radio Engineering Institute, Wash., D. C.

Our sincere thanks in Freddie's name to all of these generous people.

We now come to a worthwhile international donation. We received a letter from J. Donohoe of North Shields, England. The gentleman is a time-switch manufacturer who wants to contribute to the Freddie fund, but unfortunately currency restrictions forbid sending English money to the dollar area at the present time.

Mr. Donohoe, however, donated a hand-wound 35-day clockwork electric control switch capable of opening and closing a circuit once every 24 hours. It is an ingenious switch which can omit any specified day or days and will control A.C. or D.C. circuits up to 600 volts and 100 amperes. It is just the thing for a store or plant to automatically switch on lights or a number of appliances. We are printing a picture here for those interested in this switch.

The first person who forwards the fund \$73.00, which is the cost of this switch, will receive the switch from Mr. Donohoe, direct from England. (There may be a small American import duty on this.) The \$73.00 will be turned over to the Freddie Fund. Mr. Donohoe supplied us with circulars of the switch, a copy of which we shall be

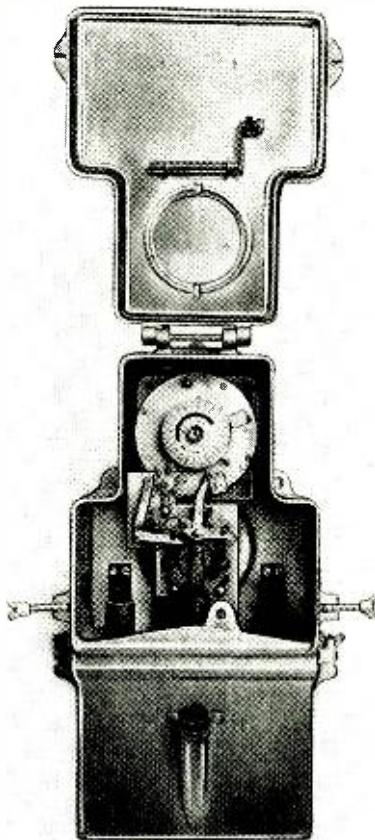

Photo of the electric control switch.

OPPORTUNITY AD-LETS

Advertisements in this section cost 25c a word for each insertion up to and including the March 1951 issue. Beginning with the April 1951 issue the rate will be 35c a word for each insertion. Name, address and initials must be included at the above rate. Cash should accompany all classified advertisements unless placed by an accredited advertising agency. No advertisement for less than ten words accepted. Ten percent discount six issues, twenty percent for twelve issues. Objectionable or misleading advertisements not accepted. Advertisements for March, 1951, issue, must reach us not later than January 24, 1951.

Radio-Electronics, 25 W. Broadway, New York 7, N. Y.

CATHODE RAY TV TUBE MANUFACTURER—one of the oldest in field—seeks representation. Sell to manufacturers, jobbers or stores. Exclusive territories. Write Box F51-1, Radio-Electronics, 25 West Broadway, New York 7, N. Y.

SPEAKER REPAIRS at wholesale prices. Guaranteed work. Amprite Speaker Service, 70 Vesey St., New York 7, N. Y.

MAGAZINES (BACK DATED)—FOREIGN, DOMESTIC Arts, Books, booklets, subscriptions, pin-ups, etc. Catalog 10c (refund). Ciccone's, 86-22 Northern Blvd., Jackson Heights, N. Y.

FOR SALE: ONE NEW RADIO TOWER—126-foot height. Still in crate. County of Lake, Court House, Waukegan, Ill.

WE REPAIR, EXCHANGE, SELL ALL TYPES OF electrical instruments, tube checkers and analyzers. Hazleton Instrument Co. (Electric Meter Laboratory), 140 Liberty Street, New York, N. Y. Telephone—BArclay 7-1239.

LANCASTER, ALLIANCE & ROMMEL, 436 BOWEN Building, Washington, D. C. Registered Patent Attorneys. Practice before United States Patent Office. Validity and Infringement Investigations and Opinions. Booklet and form "Evidence of Conception" forwarded upon request.

WANTED: AN/APR-4, other "APR", "ARR", "TS", "IE", ARC-1, ARC-3, everything Surplus, Special tubes, Tech Manuals, Lab quality Test Equipment, etc. Describe price in first letter. Littell, Farhills Box 26, Dayton 9, Ohio.

RADIOMEN, SERVICE MEN, BEGINNERS — MAKE more money, easily, quickly. \$250 weekly possible. We show you how. Information free. Merit Products, 216-321, 32nd Avenue, Springfield Gardens 13, New York.

RADIO—TELEVISION—ELECTRONICS—TUTORING \$5 per lesson—Mo. Tech., 3907 North 25th Street, St. Louis 7, Missouri.

PHONOGRAPH RECORDS (CHEAP). Catalogue. Paramount, FF-313 East Market, Wilkes-Barre, Penna.

AMATEURS—RADIO AND ELECTRICAL RESEARCH Engineering. Hy Twillmann, R.R.#1, Chesterfield, Mo.

Print Your Own
Cards, Stationery, Advertising, Circulars and Titles. Save money. **Print for Others, Good Profit!** easy rules. Have home print shop. **Finest printing line engraving, too. Sold direct from factory only. Write for free catalog of outfits and all details.**
KELCY PRESSES, P-97, Meriden, Conn.

HAVE YOU A JOB FOR A TRAINED TECHNICIAN?

We have a number of alert young men who have completed intensive training in Radio and Television Repairing. They learned their trades thoroughly by working on actual equipment under personal, expert supervision. If you need a trained man, we invite you to write for an outline of our course, and for a prospectus of the graduate. No fees, of course. Address:

Placement Manager, Dept. P108-2
COMMERCIAL TRADES INSTITUTE
1400 Greenleaf Chicago 26

GREYLOCK TUBES
MORE THAN 400 TYPES LISTED

We're STILL DELIVERING Better than 90%!

Complete stocks of Standard Brand Lines, including
AMPRITE—Microphones
EICO—Instrument Kits
EXCELLITE—Tools
EBY—Parts
WALSCO—Chromatals & Tools
HOWARD SAMS—Photofacts
TV Antennas & Accessories.

Write TODAY for our complete Catalog.

GREYLOCK ELECTRONICS SUPPLY CO.
Dept. C-2
115 Liberty Street New York 6, N. Y.

American Beauty
ELECTRIC SOLDERING IRONS
for the most RUGGED or DELICATE Jobs

5 SIZES

from 50 Watts to 550 Watts

USED THROUGHOUT THE WORLD FOR MORE THAN A HALF CENTURY

THERMO-STATICALLY CONTROLLED TEMPERATURE REGULATING STAND

● A device for regulating the heat of an electric soldering iron while at rest—Thermostat may be set to maintain iron at working temperature, ready for instant use, or at a lower heat.



NO. 118-2

AMERICAN ELECTRICAL HEATER COMPANY
DETROIT 2, MICHIGAN
 established 1894

INCREASE SENSITIVITY OF COLD-CATHODE TUBE

By **DR. HARRY PEACH*** AND **EDWARD SPIERER**

The sensitivity of a cold-cathode triode can be increased appreciably by adding an external electrode to it. The extra electrode not only preconditions the tube for added sensitivity, but also shields it from external disturbing influences.

The conventional cold-cathode triode such as the 0A4-G or the 1C21 has an anode, a cathode which is not heated, and a third element called the starter anode. In normal operation, a potential of about 60 to 80 volts is applied to the starter anode to start ionization between this element and the cathode. Once a small ion current has started, it transfers itself to the main anode and this becomes the plate current.

An additional external electrode can be supplied to the tube by coating the glass envelope with a suitable conducting material such as a layer of colloidal graphite or a metal or perhaps by a conductive layer such as might be provided by metal spraying. A small part of the tube envelope can be left uncoated so that it is possible to see the main discharge in the tube.

A connection can be made to this external electrode by running a narrow band of the conductive coating material over the base of the tube to a convenient unused pin. Avoid running this band over sharp edges, as this tends to break the connection. Several layers of shellac or other nonconducting plastic material can be used to protect the coating.

The function of the external electrode is to aid the ignition process in the tube and to increase its sensitivity by causing partial ionization of the inert gas it contains. The starter anode is then used to control the initiation of the main discharge. Since the gas in the tube is already partially ionized, the starter anode is much more sensitive.

For best results the voltages applied to the tube must have the correct phase relationship. The potential applied to the external electrode should be in phase with the potential on the main anode, while it is best to keep the voltage on the starter anode 180° out of phase with the voltage on the external anode. Thus the starter electrode potential is negative with respect to the cathode potential, while at the same time the external electrode and the main anode are positive with respect to the cathode. This condition is maintained while the tube is conducting.

Besides making the tube more sensitive, the external electrode greatly reduces and in many cases eliminates the fluttering which is common to cold-cathode tube circuits. The added electrode also makes it possible to include resistances in the order of 100 megohms in series with the starter electrode, so that only very small currents flow through this circuit and much less electrical energy will start ionization.

*Physics Dept., Brooklyn College

AT LAST — A COMPLETE BOOK ON RADIO CONTROL!

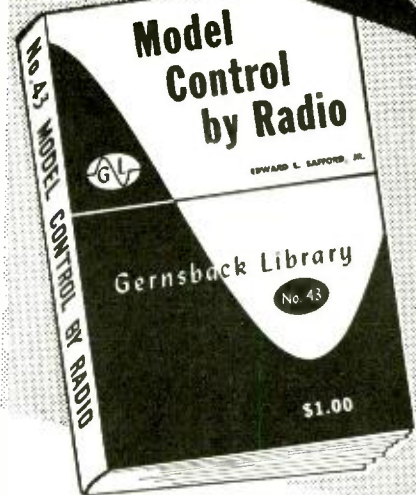

112 Pages—\$1.00

JUST OFF THE PRESS!

Here, at last, is the first complete book on model control by radio. It opens a whole fascinating new field to experimenters, radio amateurs, research men and technicians.

The author, Edward L. Safford, Jr., Instructor, Guided Missile Electronics at Fort Bliss, Texas, is an authority on radio control.

He gives you, in effect, two books. One covering the fundamentals of transmission systems, decoders, relays and other basic concepts is an excellent guide book for beginners and a working handbook for experts. The other, telling you how to build not only complete systems but various components as well, is a practical how-to-do-it book on construction. All the important details are illustrated with explanatory photos and diagrams.

Model Control by Radio is must reading for the expert, the beginner or anyone who has ever tinkered with a circuit. This new book will become a classic in the field. Right now, it's a tremendous buy at the low price of only \$1.00. Don't wait, order your copy today.

LIST OF CONTENTS

- CHAPTER 1—Basic Concepts
- CHAPTER 2—Coding and Coders
- CHAPTER 3—Transmission Systems
- CHAPTER 4—Receivers
- CHAPTER 5—Decoders
- CHAPTER 6—Power Control Circuits
- CHAPTER 7—Servomotors
- CHAPTER 8—Receiver Construction
- CHAPTER 9—Transmitter Construction
- CHAPTER 10—Construction of Coders and Decoders
- CHAPTER 11—Complete Control Systems
- CHAPTER 12—Hints and Adjustments

See Your Distributor—or use coupon
RADCRAFT PUBLICATIONS, INC.

RADCRAFT PUBLICATIONS, INC., Dept. 21
25 West Broadway
New York 7, N. Y.

My remittance for \$..... is enclosed for which please send me postpaid..... copies of your new book MODEL CONTROL BY RADIO.

Name.....
 Street.....
 City..... Zone.... State.....

Radio Thirty-Five Years Ago
In Gernsback Publications

HUGO GERNSBACK
Founder

Modern Electrics	1908
Electric Experimenter	1913
Radio News	1919
Science & Invention	1920
Television	1927
Radio-Craft	1929
Short-Wave Craft	1930
Television News	1931
Wireless Association of America	1908

Some of the larger libraries still have copies of ELECTRICAL EXPERIMENTER on file for interested readers.

February 1917
ELECTRICAL EXPERIMENTER

The Kilbourne and Clark Radio System
United States and Japan Linked by Radio

The Design of Large Radio Receiving Transformers, by Chas. S. Ballantine
A Horizontal Mineral Detector, by Robert S. Quimby

A Low Potential Arc Transmitter for Radio Stations, by Gordon C. Farmer

The How and Why of Radio Apparatus
Up-to-Date Radio Amateur Switchboard, by H. C. Graham

Multi-Mineral Duplex Point Detector Stand, by Bert Speicher

A New Circuit for Undamped Wave Signal Radio, by Dr. Gordon M. Christine

Standard Radio Terms Defined

CORRECTION

A chart listing the pertinent physical and electrical characteristics of standard electromagnetic television picture tubes was printed on pages 36 and 37 of the January, 1951 issue. The second column from the right referred to tube base wiring diagrams which were inadvertently omitted when the magazine went to press. The base diagrams are printed here with our suggestion that you clip and file them along with the chart.

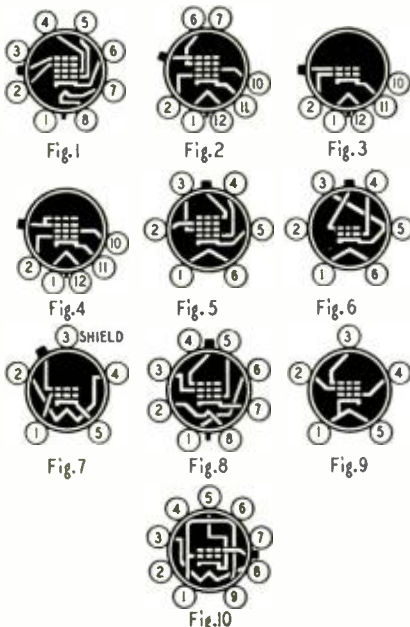

The 17CP4—shown in bold-face type on the chart—is a rectangular tube and should be shown in light-face type as are the other rectangular tubes.

Because of glass shortages and limited production facilities, RCA is currently producing four versions of the 16G- and two versions of the 19A-picture tubes. The 16GP4 and 19AP4-A have Filterglass faces without frosting. The 16GP4-B and 19AP4-B have frosted Filterglass faces. The face of the 16GP4-A is unfrosted clear glass and the 16GP4-C has frosted clear glass. As soon as conditions permit, only the 16GP4-B and 19AP4-B will be made.

SCIENCE LECTURES ON TV

Television is helping to make complex modern science more understandable to the layman. "The Johns Hopkins Science Review" is a regular Tuesday night Du Mont network program in which scientists on the faculty of Johns Hopkins University at Baltimore demonstrate current advances in all fields of science. One of the aims of the program is to show the need for continued scientific research.

In the opening program on Oct. 9, a group of psychologists showed what happens to our physiological makeup when we are frightened and suggested how to overcome fear. Program planners have devised methods to show the audience what micro-organisms look like through a microscope, an X-ray photograph being taken and developed, the human heartbeat as seen through a fluoroscope, and the pattern of air waves striking a plane traveling at 1,000 miles per hour.

DIFFERENCES IN 6S4 TUBES

The Admiral Service Dept. reports that some brands of 6S4 do not have an internal connection between pins 3 and 6. This may make it necessary to connect a wire jumper between these pins on the tube socket in all 20T1 and early 20V1 chassis.

BUY DIRECT SAVE!!

From Factory **\$175⁹⁵**
Fed. Tax Incl. (Less CRT)

New Improved RCA Licensed 16"—630 32 Tube Chassis
Complete with
• New Electro-Scope Magic Eye Tuning Indicator
• Completely wired and aligned by expert technicians.
• Newly developed keyed automatic gain control.
• Latest type Standard Coil tuner.

NEW SENSATIONAL MODEL 622
22 Tube Chassis with co-channel sound (not inter-carrier) **\$144⁹⁵**
Tax Incl. (Less CRT)

ALL SIZES—BRAND NAME PICTURE TUBES AVAILABLE
Both Chassis for 16", 17", 19" or 20" Tubes
Regular RMA guarantee on all tubes and chassis
Beautiful cabinets for above—available
Terms: \$25.00 deposit on all orders—Balance C.O.D.
F.O.B.—N. Y. Factory
Prices subject to change without notice

AD - RITZ 158 Grand Street
MFG. CORP. New York, N. Y.
Phone WO 4-6763

BUFFALO RADIO SUPPLY
219-221 Genesee St., Dept. RE 12
Buffalo 3, N. Y.

RIDER PUBLICATIONS AT TERRIFIC BARGAIN PRICES
Radiomen save 20% off regular dealer net. Radio Parts Jobbers save 30% off regular dealer net, or swap for other manuals in original wrappings. We also buy excess stocks of new Rider publications.

HEAT GUN

Streamlined pistol grip heat gun. Vivid red housing. 20 Cu. Ft. per min. of hot air at 160°F. Lifetime-lubricated 1/2" DC motor of the rugged vacuum cleaner type. Produces a hurricane of hot or cold air. Blow out dust from radio chassis. Dry ignition system. Heat carburetors. Quickly-dry paint. Thaw out radiators or water pipes. Will dry your wife's hair in half the time of ordinary hair dryer. Also good for drying stockings or clothing, or defrosting refrigerator instantly. Only \$12.95. Satisfaction guaranteed or money refunded if returned prepaid within 5 days.



COMPRESSED AIR INSTANTLY ANYWHERE

Portable Air Compressor and storage tank. Ruggedly built. Best Materials. Lifetime lubricated ball-bearing main bearing on shaft. Unusual design forever eliminates valve trouble, the most common fault in air compressors.

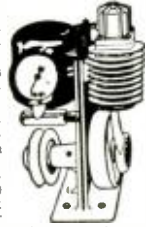

PATENTED unique air intake system increases efficiency tremendously so that air output is much greater than that from larger compressors powered by heavier motors. Delivers approximately 3500 cu. inches of air per minute at maintained pressure of 30 lbs., or will inflate a 30 lb. truck tire in less than one minute. Complete with 100 lb. gauge. Flinger tip adjustment allows setting of output pressure at any value, which will automatically be maintained. Works from any 1/2" H.P. motor. Useful for spraying paint, lacquer, disinfectant, insecticide, annealing or brazing with natural gas, inflating tires, etc. Price \$14.50 postage prepaid anywhere in the U. S. Efficient, completely adjustable siphon type spray gun complete with 12 ft. of 100 lb. tested hose, only \$7.75 with pint container, also prepaid.

LINE FILTERS

Type "A"—Each unit contains two 4 Mfd. oil filled condensers and a high inductance 50 Amp. choke in fully shielded case. Suitable heavy current connectors are provided to attach to the input and output conductors at each end of the filter from your input and output wires. A filter with numerous uses on oil burners, refrigerators, boats, automobiles and wherever noise is to be suppressed or interference abolished. A \$17.00 value for \$2.98.

Type "B"—Heavy duty line filter consisting of 2 condensers and R. F. choke in plated steel case. Conservatively rated at 4 amps and 600 volts. Perfect for refrigerators, oil burners, power supply input of signal generators or to block out almost any interference you can think of. Super special 75c each for 10 for \$5.00

CONDENSERS

Below is designated the quantity of nationally known tubular condensers that you can buy for a DOLLAR BILL.

.0005-15 * .001 .002 or .005-11 * .01
.02 or .03-10 * .05-9 * .1-8 * .25-6 * .5-4.

CYBERNETICS!

RT1463 12 Stage Electronic Brain containing 3—7F7, 1—7Y1, 3—7N7, 4 potentiometers, numerous resistors, filter and bypass condensers, filter chokes, power and audio transformers, and six sensitive plate relays. A military development that provided amazing stepless control proportional to correction required, in the original application. This phenomenal unit, with its 3 multi-stage push-pull amplifiers and six 5,000 ohm relays in bridge circuits will accurately control any 3 operations, related or unrelated, in minutely adjustable reverse directions. 9"x7"x8" black crackle aluminum case. Brand new in original carton \$14.95

SIGNAL GENERATOR

Genuine Laboratory-type precision signal generator Manufactured and sold for \$68.00 each in large quantities during the war by Northeastern Engineering Corp., one of the top manufacturers of electronic equipment for the U. S. Govt. Five fundamental bands starting at 150 Kc. Strong harmonics up to 120 Mc. Five step ladder type attenuator as well as potentiometer output control. Regular 1000 cycle audio oscillator using vacuum tube, not a cheap neon sawtooth audio oscillator. Audio output separately adjustable externally. Weight without packing material 16 lbs., which should show what a world of difference exists between this signal generator and the ordinary cheap oscillator used by the average serviceman. Complete with fused plug and coaxial output lead. Super Special \$28.75



BUILD 15 RADIOS AT HOME

With the New Improved 1951
Progressive Radio "EDU-KIT"

ONLY
\$19⁹⁵



- FREE TOOLS WITH KIT
- ABSOLUTELY NO KNOWLEDGE OF RADIO NECESSARY
- NO ADDITIONAL PARTS NEEDED
- EXCELLENT BACKGROUND FOR TELEVISION
- 10 DAY MONEY-BACK GUARANTEE

WHAT THE PROGRESSIVE RADIO "EDU-KIT" OFFERS YOU

The Progressive Radio "Edu-Kit" offers you a home study course at a rock bottom price. Our Kit is designed to train Radio Technicians, with the basic facts of Radio Theory and Construction Practice expressed simply and clearly. You will gain a knowledge of basic Radio Principles involved in Radio Reception, Radio Transmission and Audio Amplification.

You will learn how to identify Radio Symbols and Diagrams; how to build radios, using regular radio circuit schematics; how to mount various radio parts; how to wire and solder in a professional manner. You will learn how to operate Receivers, Transmitters, and Audio Amplifiers. You will learn how to service and trouble-shoot radios. In brief, you will receive a basic education in Radio exactly like the kind you would expect to receive in a Radio Course costing several hundreds of dollars.

THE KIT FOR EVERYONE

The Progressive Radio "Edu-Kit" was specifically prepared for any person who has a basic knowledge of the English language, and has the desire to learn Radio. The Kit has been used successfully by young and old in all parts of the world. It is not necessary that you have even the slightest background in science or radio.

The Progressive Radio "Edu-Kit" is used by many Radio Schools and Clubs in this country and abroad. It is used by the Veterans Administration for Vocational Guidance and Training.

The Progressive Radio "Edu-Kit" requires no instructor. All instructions are included. All parts are individually boxed, and identified by name, photograph and diagram. Every step involved in building these sets is carefully explained. You cannot make a mistake.

PROGRESSIVE TEACHING METHOD

The Progressive Radio "Edu-Kit" comes complete with instructions. These instructions are arranged in a clear, simple and progressive manner. The theory of Radio Transmission, Radio Reception and Audio Amplification is clearly explained. Every part is identified by photograph and diagram; you will learn the function and theory of every part used.

The Progressive Radio "Edu-Kit" uses the principle of "Learn By Doing". Therefore you will build radios to illustrate the principles which you learn. These radios are designed in a modern manner, according to the best principles of present-day educational practice. You begin by building a simple radio. The next set that you build is slightly more advanced. Gradually, in a progressive manner, you will find yourself constructing still more advanced radio sets, and doing work like a professional Radio Technician. Altogether you will build fifteen radios, including Receivers, Amplifiers and Transmitters.

The Progressive Radio "EDU-KIT" Is Complete

You will receive every part necessary to build 15 different radio sets. This includes tubes, tube sockets, variable condensers, electrolytic condensers, mica condensers, paper condensers, resistors, tie strips, coil, tubing, hardware, etc. Every part that you need is included. In addition these parts are individually packaged, so that you can easily identify every item.

TROUBLE-SHOOTING LESSONS

Trouble-shooting and servicing lessons are included. You will be taught to recognize and repair troubles. While you are learning in this practical way, you will be able to do many a repair job for your neighbors and friends, and charge fees which will far exceed the cost of the Kit. Here is an opportunity for you to learn radio and have others pay for it.

FREE EXTRAS IN 1951

- ELECTRICAL AND RADIO TESTER
- ELECTRIC SOLDERING IRON
- BOOK ON TELEVISION
- RADIO TROUBLE SHOOTING GUIDE
- MEMBERSHIP IN RADIO TELEVISION CLUB
- CONSULTATION SERVICE • QUIZZES

The Progressive Radio "Edu-Kit" is sold with a 10-day money-back guarantee. Order your Progressive Radio "EDU-KIT" Today, or send for further information.

Postage prepaid on cash orders—U. S. D. orders accepted in U. S. A.

PROGRESSIVE ELECTRONICS CO.
497 UNION AVE., Dept. RE-44 Brooklyn 11, N. Y.

OUTPUT TRANSFORMERS

Partridge Transformers, Ltd.
Talworth, Surrey, England

A line of push-pull output transformers designed for the Williamson amplifier have been developed by Partridge. The WWFB/O series of transformers is rated at 16 watts continuous output. Primary impedances of

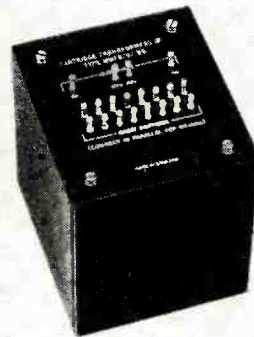

10,000, 6,600, and 4,000 ohms are available. Secondaries are available with three different impedance combinations. Frequency response is within 1 db from 5 cycles to 50,000 cycles. Maximum harmonic distortion is 0.62%. Primary inductance (at 4 volts, 50 cycles) 100 to 130 h. Leakage inductance 15 to 20 millihenrys. Primary will handle 80 ma d. c. in each half.

RAILROAD SPEAKER

Racon Electric Co. Inc.
New York, N. Y.

The Model RR-40 dual speaker is designed to meet the rigorous requirements of railroad sound systems. Hav-

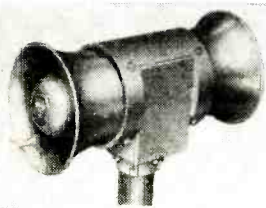

ing high intelligibility, and unusual clarity and sensitivity for talk-back purposes, it is also well suited for other industrial installations such as open pit mines, steel mills, etc.

The speaker has a heavy noncorrosive aluminum center-casting with a weather-proof steel-bell re-entrant speaker at each end of the opening. Inside is ample room for line transformer and minor accessories, and heavy gaskets prevent water seepage.

Frequency range of the speaker is 350 to 6,000 cycles; total power capacity, 40 watts; peak capacity, 70 watts; impedance (speakers in parallel), 8 ohms; sensitivity at 4 feet with 1 watt input at 1,000 cycles, 108.5 db; bell diameter, 9 1/2 inches; length, 20 inches.

COMPARATOR BRIDGE KIT

Electronic Instrument Co.
Brooklyn, N. Y.

A new addition to the Eico line of kits and instruments, the model 950K R-L-C comparator bridge kit permits accurate comparison of any resistance,

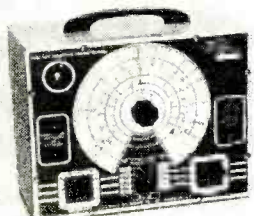

capacitance, or inductance with any complementary component as a given standard. The instrument tests resistors from 0.5 ohms to 500 megohms in four

convenient ranges; all types of capacitors from 10 μ f to 5,000 μ f, with leakage and power factor tests.

The tester uses the latest bridge type circuit and is powered by a 110-volt transformer and rectifier. All measurement ranges are calibrated on the front panel and no multipliers or charts are needed. The kit is supplied with all parts and complete instructions. Its dimensions are 10 x 8 x 4 3/4 inches.

NEW TUBE TESTERS

Radio City Products Co., Inc.
New York, N. Y.

To insure against obsolescence, this new line of tube testers has ample provision for additional tube elements and tube bases when they appear. Two additional circuit element switches, not used, and two additional socket blanks are included. The testers have sockets for the latest miniature tubes and approximately 1,000 listings on its high-speed roll chart.

Three models of the tester are available: an open face model No. 323C;

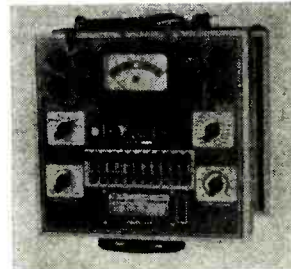

the combination case No. 323PC (illustrated); and the 323 counter merchandiser. The same tube tester is also available as part of the 807 combination tube and set tester and the 8773 complete service shop.

H PAD FOR TV

Centralab Div., Globe-Union Inc.
Milwaukee, Wis.

The television H-pad is a printed-circuit attenuator for TV receivers in areas where strong local signals cause picture and audio distortion by overloading the r.f. portion of the receiver. It is a 4-terminal network inserted between the 300-ohm line and receiver.

The four available types provide insertion losses of 10, 20, 30, and 40 db. Impedance is 300 ohms, and the dimensions are 1 1/2 x 1 3/16 x 3/16 inches.

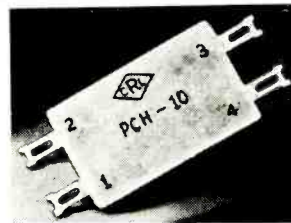

PORTABLE OSCILLOSCOPE

RCA Test Equipment
Harrison, N. J.

Designed to combine the advantages of a large screen size with compactness, portability, and ease of operation, the RCA WO-56A 7-inch oscilloscope features three push-pull stages of direct-coupled amplification, wide frequency response, 11 millivolt-per-inch deflection sensitivity, and an excellent square-wave response.

The high-frequency response of the instrument is adequate for TV servicing and will display square waves without severe distortion up to 100 kc. The low-frequency response is flat to d.c. Frequency compensated step and vernier attenuators do not affect the frequency response regardless of gain setting.

Preset sweep oscillator positions of 30 and 7875 cycles permit instantaneous switching between horizontal and vertical TV deflection and sync circuits. The sweep oscillator provides a sawtooth output from 3 to 30,000 cycles, the sweep trace may be expanded to three times the screen diameter. Push-pull deflection for both horizontal and vertical traces reduces astigmatic distortion and allows a sharp trace over the entire useful area of the screen.

The WO 56A cathode-ray oscilloscope comes complete with direct probe and cable, low-capacitance probe, ground lead, graph screen, and alligator clip.

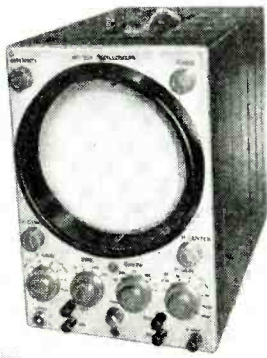

10-WATT AMPLIFIER

Rauland-Borg Corp.
Chicago, Ill.

A low-cost amplifier designed for custom installations, the model 1810 amplifier is equipped with a 3-position

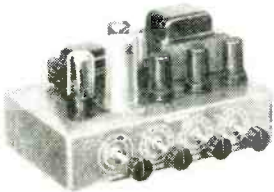

selector for magnetic or crystal pickup and high-level auxiliary input, separate boost-type bass and treble tone controls, and a compensated volume con-

trol to increase lows at reduced volume. Output measured at 100, 400, and 5,000 cycles is 10 watts at 3% harmonic distortion. Intermodulation distortion taken at 60 and 7,000 cycles with 4-to-1 ratio is 1.5% at 2 watts (home level), 3% at 5 watts, and 5% at 10 watts. Gain is 103 db for magnetic pickups, and 80 and 73 db for the two high-level inputs. Frequency response is 40 to 20,000 cycles plus or minus 1 db. The tube lineup is 1-65C7, 1-65Q7, 1-65L7, 2-6V6-GT, and 1-5Y3-GT.

DYNAURAL AMPLIFIER

H. H. Scott, Inc.
Cambridge, Mass.

The 210-B Dynaural amplifier is a new version of the 210-A amplifier designed for high-quality music and laboratory installations. Frequency response is flat from 12 to 22,000 cycles; harmonic distortion is less than 0.5% at full 20 watts output; first-order difference-tone intermodulation (the distortion most annoying to the ear) less than 0.1% at full

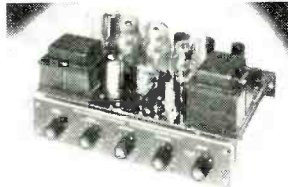

output. An automatic loudness control compensates for the insensitivity of the ear at low volumes; hum level is 84 db or more below full output; and the Dynaural noise suppressor virtually eliminates record scratch and rumble without affecting the music response.

VOLTAGE REGULATOR

JFD Manufacturing Co., Inc.
Brooklyn, N. Y.

Engineered to maintain a constant line voltage, these voltage regulators

end. Voltage drop is negligible at 110 volts, but increases as the line voltage increases. No. 93-7 is rated at 300 watts and No. 93-8 at 375 watts.

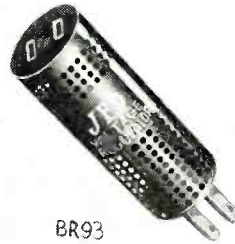

BR93

TV ANTENNAS

Walter L. Schott Co.
Beverly Hills, Cal.

The new Walsco Signal King antenna is an all-channel antenna with a signal director to improve gain on high-band channels and reduce ghosts. While designed for ruggedness, the antenna is easily put up with just two nuts and three thumbscrews.

TAPE RECORDER

Webster-Chicago Corp.
Chicago, Ill.

The Web Cor tape machine records at 3 3/4 and 7 1/2 inches per second with double track, giving 2 hours of play at the slower speed. Its fast rewind speed will run through a 1,200-foot reel of tape in 3 minutes, in either direction. It uses five tubes, plus rectifier in a straight a.c. circuit and has a 6-inch speaker.

The machine is portable and weighs 40 pounds. Standard equipment included with it are a microphone, power cord, empty reel, and one 1,200-foot spool of tape.

FLUSH-MOUNTED SOCKETS

Mosley Electronics
Overland, Mo.

These flush-mounted, low-loss sockets fit in a standard electrical outlet box and has receptacle plates to provide an easy way to connect to TV antennas and to change from one antenna to another.

The single flush socket for 300-ohm line terminates a lead-in concealed in the wall and is for antennas without rotator; the dual flush socket is the same but has two sockets for installations, using two antennas with separate

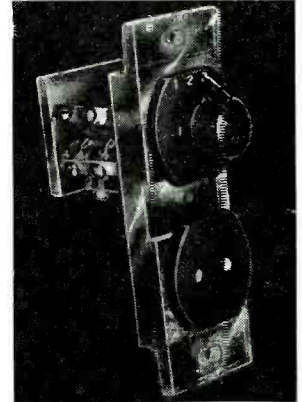

lead-ins; another socket provides termination for 300-ohm lead-in and for a 4-wire rotator control cable. One model (illustrated) provides a three-position switch and socket combination for multiple antenna installations.



It's New! IT'S A "MUST" FOR RADIO-TV MEN!

IT'S YOURS FOR 7 DAYS FREE TRIAL

R. A. SNYDER, General Manager
Technical Book Division
Coyne Electrical & Television-
Radio School

If you want to get ahead faster in big pay Television work . . . if you want time-saving, money making TV data at your finger-tips . . . you need COYNE'S NEW GIANT "TELEVISION CYCLOPEDIA." 750 fact-packed pages cover every phase of Television. 450 photos, charts, diagrams make it easy to understand. All subjects in alphabetical order for quick reference. Prove to yourself that this is the world's handiest, most complete and up-to-date book yet published in Television by taking advantage of COYNE'S 7 day FREE EXAMINATION OFFER.

PICTURE PATTERNS, COLOR TV, UHF, ALIGNMENT, CONVERTERS, ADAPTERS, TELEVISION FROM A TO Z

Written by H. P. Manly (author of the Nationally famous "CYCLOPEDIA OF RADIO") and edited by the COYNE instruction staff, the "TELEVISION CYCLOPEDIA" is a "must" for every radio-television man. This brand new book tells you "in a flash" why things happen in television receivers—how to handle any TV problem. If you want to know about Picture Tube patterns you'll find a complete section on the subject. You get complete information (with dozens of actual Picture Patterns) on HOW TO USE THEM IN ANALYZING TV SETS. Completely covers ALIGNMENT, AMPLIFIERS, ANTENNAS, FREQUENCIES . . . UHF and COLOR TV . . . converters, adapters, television r-f . . . ion traps and every other TV subject. Every subject is discussed in A-B-C order with full descriptions and explanations. Mathematics limited to easy arithmetic . . . formulas simplified . . . truly TELEVISION FROM A TO Z.

USE THE CYCLOPEDIA 7 DAYS . . . FREE

See this great "COYNE TELEVISION CYCLOPEDIA" absolutely FREE for 7 days. Send no money! Just fill in and mail FREE TRIAL coupon. Look the book over for 7 days. If you keep it send us \$5.95 plus postage—or return the book and owe nothing. But act now—offer may be withdrawn at any time.

BRAND NEW 1951 PUBLICATION

HERE'S WHAT YOU GET IN THIS GREAT CYCLOPEDIA

- TV from A to Z for "in a flash" reference
- 1951 Publication
- Shop & Field Tested Servicing Data
- Dozens of Picture Tube Patterns
- Complete Set of Wave Forms
- Color TV and UHF
- Over 450 Illustrations
- 750 Pages of "How and Why" in Practical Terms

FREE TRIAL COUPON

COYNE ELECTRICAL & TELEVISION-RADIO SCHOOL, Dept. 21-T1
500 S. Paulina St., Chicago 12, Ill.

I'm interested. Send me a copy of the COYNE TELEVISION CYCLOPEDIA for 7 days FREE EXAMINATION per your offer.

NAME PAGE

ADDRESS

CITY ZONE STATE

Check here if you are enclosing \$5.95 or wish the book sent COD (you pay the postman \$5.95 plus COD fee when delivered). You save postage. Same 7 day examination and money back satisfaction guarantee.

COYNE ELECTRICAL AND TELEVISION-RADIO SCHOOL
An Institution Organized Not for Profit
500 SO. PAULINA ST. • DEPT. 21-T1 • CHICAGO 12, ILL.

#630 SUPER DELUXE 31-TUBE (20" RECTANGULAR PICTURE TUBE) TV CHASSIS

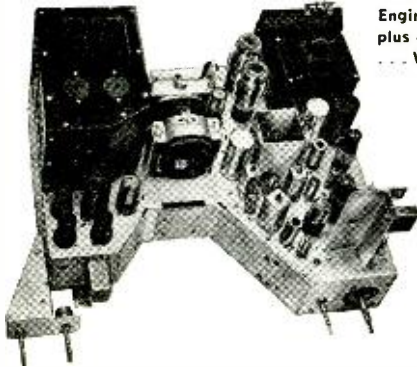

Engineered in strict adherence to the genuine RCA #630, plus added features . . . LARGER POWER TRANSFORMER . . . VOLTAGE DOUBLER . . . AGC . . . STANDARD TUNER.

OPERATES ALL 20", 17", 16" RECTANGULAR PICTURE TUBES

COMPLETE, ready to PLUG IN AND PLAY **\$187.97**
Incl. speaker, knobs & hardware . . . (less CRT)

RECTANGULAR PICTURE TUBES

- 20" — #20DP4A \$74.89
- 17" — 17RP4A 46.78
- 16" — 16RP4A 39.63

KNOWN MFR . . . LICENSED BY RCA

CUSTOM-BUILT TV CABINETS FOR #630 CHASSIS (16" TO 20")

4 leading styles in genuine mahogany or walnut. (Blonde 10% extra). WINDSOR and NEW YORKER when open look like STREAMLINER. Ready cut for easy, perfect assembly for 16", 17" or 20" rectangular or 16" or 19" round picture tube. Complete with hardware, supports and safety glass.

THE VOGUE
Most Popular Table Model.

THE NEW YORKER
A Deluxe Cabinet With a Piano Finish.

THE STREAMLINER
Center Drop Panel Conceals Tuning Knobs.

THE WINDSOR
Hand Tooled Leather in Green, Red or Brown.



16" — H-21", W-21", D-21"
17" — H-21", W-21", D-21"
20" — H-27", W-21", D-21"

\$47.45



H-42", W-26", D-25"
\$96.87



H-42", W-26", D-25"
\$74.98

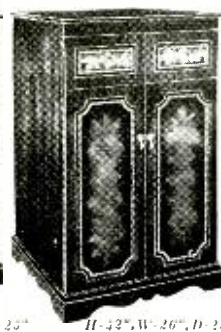

H-42", W-26", D-25"
\$129.74

31-TUBE DELUXE TELEVISION KIT (16" to 20" rectangular) Complete (less CRT) \$166.49
29-TUBE STANDARD TELEVISION KIT (10" to 12 1/2") Complete (less wire and CRT) 139.62

#630 TV PARTS . . . TOP QUALITY . . . LOW PRICES

RCA FRONT END TUNER, compl. w/tubes . . .	\$22.49	PUNCHED CHASSIS PAN, cadmium plated 630-KIT, screws, nuts, rivets, washers . . .	\$4.87
STANDARD TURRET TUNER, com. w/tubes . . .	22.49	HI VOLTAGE CAGE ASSEMBLY, complete . . .	1.69
ESCUTCHEON PLATE, for either tuner69	VOLTAGE DIVIDER SHIELD & COVER . . .	3.73
COMPLETE SET OF KNOBS, incl. decals . . .	1.34	ELECTROLYTIC COND. SUB-CHASSIS SOUND DISCRIMINATOR SHIELD . . .	1.79
COMPLETE SET OF KNOBS, (Gold) " . . .	2.49	TUBE CRADLE BRACKET94
POWER TRANSFORMER, 295ma. 201T6 . . .	9.97	DEFLECTION YOKE BRACKET19
VERTICAL OUTPUT TRANS. 204T2 . . .	2.69	DEFLECTION YOKE MOUNTING HOOD57
VERTICAL BLOCKING TRANS. 208T2 . . .	1.32	FOCUS COIL BRACKETS Per set	.29
HORIZONTAL OUTPUT TRANS. 211T1 . . .	2.47	CATHODE TRAP COIL SHIELD59
HORIZONTAL OUTPUT TRANS. 211T3 . . .	2.98	CHASSIS MOUNTING BRACKETS . . . set of 4	.49
HORIZONTAL OUTPUT TRANS. 211T5 . . .	3.98	BRIGHTNESS & HOLD CONTROL BRACKET39
FOCUS COIL, 24, ohms. 202D1 . . .	2.29	WIDTH CONTROL BRACKET44
FOCUS COIL, 470 ohms. 202D2 . . .	3.42	TUNER SHAFT BRACKET59
DEFLECTION YOKE, 60° 201D1 . . .	2.97	SET OF 18 TERMINAL STRIPS16
DEFLECTION YOKE, 70° 206D1 . . .	3.98	CORONA TERMINALS set of 2	.17
SOUND DISCRIMINATOR TRANS. 203K1 . . .	1.12	CORONA RING59
1st PIX I.F. TRANSFORMER, 202K2 . . .	1.08	TUBE SHIELD & CLIP 2 sets	.08
2nd PIX I.F. TRANSFORMER, 202K3 . . .	1.08	MINIATURE WAFER SOCKET (10) . . . ea.	.09
1st & 2nd SOUND I.F. TRANS. (2) 201K1 . . .	1.02	MINIATURE MOLDED SOCKETS (2) . . . ea.	.22
HORIZONTAL DISCRIM. TRANS. 208T8 . . .	1.49	OCTAL WAFER SOCKETS (13) . . . ea.	.07
FILTER CHOKE, 62 ohms	1.47	CATHODE RAY TUBE SOCKET, 18" leads12
CATHODE TRAP COIL, 202K4 . . .	1.08	HV KINESCOPE LEAD, with clip07
WIDTH CONTROL COIL, 201R144	TV 6' LINE CORD, with both plugs39
WIDTH CONTROL COIL, 201R448	INTERLOCK SAFETY CONNECTOR (input)29
WIDTH CONTROL COIL, keyed AGC79	AMPHENOL CONNECTOR PLUGS, set17
HORIZONTAL LINEARITY COIL, 201R339	OVAL PM SPEAKER, 5"x7"48
HORIZONTAL LINEARITY COIL, 201R549	12" PM SPEAKER, heavy alnico #5 magnet . . .	2.49
3rd & 4th PIX COILS, (2) 202L139	SPEAKER CONNECTOR PLUGS set of 2	6.94
FILAMENT CHOKES, (5) 204L109	12 1/2"—CRT MOUNTING BRACKET SET . . .	1.18
VIDEO PEAKING COIL, 203L118	16"—CRT MOUNTING BRACKET SET . . .	1.96
VIDEO PEAKING COIL, 203L218	UNIVERSAL MOUNTING BRACKET SET . . .	2.98
VIDEO PEAKING COILS, (2) 203L318	PLASTIC SLEEVE, for insulating 16AP4 . . .	6.97
VIDEO PEAKING COILS, (2) 203L418	PLASTIC SLEEVE, for insulating 16GP4 . . .	1.88
ION TRAP BEAM BENDER, (single) 203D179	PLASTIC RING, for insulating rim 16" CRT . . .	1.88
ION TRAP BEAM BENDER, (double) 203D398	PLASTIC SLEEVE, for insulating 19" CRT . . .	1.97
AUDIO OUTPUT TRANSFORMER (6K6)69	PLASTIC RING, for insulating rim 19" CRT . . .	1.96
HV RECTIFIER SOCKET ASSEMBLY, single79	TUBULAR CONDENSER KIT (37)	2.08
HV RECTIFIER SOCKET ASSEMBLY, double . . .	1.37	CERAMIC CONDENSER KIT (28)	4.28
VARIABLE CONTROL KIT (9 controls)	5.83	MICA CONDENSER KIT (11)	3.37
ELECTROLYTIC CONDENSER KIT (6)	7.37	COMPLETE SET OF GOLD KNOBS	1.38
BRACKET AND SHIELD KIT (18 items)	8.63		2.49
VIDEO AND I. F. KIT (19 items)	7.84		

BROOKS RADIO & TELEVISION CORP., 84 Vesey St. (DEPT. A) New York 7, N.Y.

A. D. Plamondon, president of the INDIANA STEEL PRODUCTS Co. and R. E. Laux, president of GENERAL INSTRUMENT CORP., were named co-chairmen of RTMA's Emergency Electronics Parts Mobilization Committee. Other new RTMA committees are the Trade Practice Committee, Benjamin Abrams, EMERSON RADIO & PHONOGRAPH CORP., chairman, and the FM Policy Committee, H. C. Bonig, ZENITH RADIO CORP., chairman. John W. Craig, vice-president of the Crosley Division of AVCO MANUFACTURING Co. was elected to fill a vacancy on the RTMA Set Division Executive Committee.

Frederick A. Hess joined the LA POINTE-PLASCOMOLD CORPORATION as sales manager for Vee-D-X TV antennas and accessories. Mr. Hess was formerly with the sales organization of Harold A. Chamberlin, Vee-D-X representative in New England and upper New York.

Hank Russell, former assistant general sales manager of the UNITED TRANSFORMER COMPANY, was promoted to the position of general sales manager. He succeeds Ben Miller, who resigned.

Mr. J. Gilman Reid, Jr. was appointed chief of the Electronics Division of the NATIONAL BUREAU OF STANDARDS. He succeeds Dr. R. D. Huntoon, who has been acting chief since the division was founded on July 1, 1950. Mr. Reid has been with the Bureau since 1937.

Howard Riordan, former vice-president and controller of the Colonial Radio Corp., has been appointed general manufacturing manager of the Radio and Television Division of SYLVANIA ELECTRIC PRODUCTS. Bernard O. Holsinger, former advertising and promotion manager of the division, was named assistant general sales manager. Sylvania also announced the appointment of H. Allen White as sales service engineer for the Radio Tube Division.

Personnel notes:

. . . Jack Whiteside, chief engineer of electronics developments at Simpson Electric Co., Chicago, is on a five-month tour presenting an illustrated lecture "Television Servicing."

. . . Victor Machin was promoted to the position of sales manager, Manufacturers' Division of SHURE BROTHERS, Chicago.

. . . M. J. Alexander, formerly with Allen B. Du Mont Labs. and Krich-Radisco, was appointed sales manager of THOMAS ELECTRONICS.

. . . Dr. Ralph L. Power will direct publicity for the 7th annual PACIFIC ELECTRONIC EXHIBIT to be held in San Francisco, August 29-31, 1951.

. . . David A. Gnessin, manager of the Columbus, Ohio, branch of Transvision and a frequent contributor to RADIO-ELECTRONICS, has been made editor of the company's house organ, *Transvision News*.

. . . Victor H. Pomper, sales manager of HERMAN HOSMER SCOTT, INC., was elected a director of the company. Edmond G. Dyett, production manager, was re-elected director and assistant treasurer.

COMMENT ON COLOR TV

Dear Editor:

I read with mild distaste your editorial "Choleric Color TV." Having seen the CBS pictures recently at two successive demonstrations, one at Gimbel's and one at CBS, I am unable to understand that attitude.

I have kept up with color photography (in theory and practice) for 30 years, and know the difficulties involved. Therefore I was quite unprepared for the virtual perfection of the CBS performance. I found little variation among the seven receivers on view. What more do you or the public want?

The much-advertised change of the syncs can be performed very simply by almost any of your readers, and the anathematized "wheel" is far less complex than a home-movie projector.

I don't like the idea of whirling filters either, but I must believe the pictures I saw. And, after all, we're still playing records by what theoretically ought to be an impossible system. No, Mr. Gernsback, this time you ain't done right by our Nell!

JAMES H. PITMAN

Chairman of English & Humanities,
Newark College of Engineering,
Belleville, N. J.

(We appreciate your letter in connection with editorial "Choleric Color TV" very much. You are quite right; there is nothing wrong whatsoever with the CBS color system, as far as color reproduction is concerned. Although a number of critics claim that it is not all that could be expected of a really good color system, most of them think that the color reproduction is pretty good. All this is beside the point, however, as far as my editorial is concerned.

The CBS system uses a small picture tube [7- or 10-inch] and a magnifying lens. Small picture tubes and magnifying lenses for black-and-white TV have been rather generally rejected by the general public. In the last year the set manufacturers have practically ceased making receivers with 7- or 10-inch tubes. In the last six months over 75% of all cathode-ray tubes delivered to set manufacturers have been 16-inch or larger. This is convincing evidence that the public is not satisfied with small tubes and magnifying lenses and that it desires large-screen pictures which at present the CBS color system cannot deliver.

It is not true that all sets can be simply converted to receive the CBS picture in black and white, as you will find by reading the article "Convert Your TV Set for Color Reception," on page 23 of the January, 1951, issue of RADIO-ELECTRONICS. In most sets it will require the replacement of several major parts and the incorporation of complicated multisection switches.

So, all in all, we don't think the CBS system, as it now exists, is a good system. We, like most TV engineers, believe the FCC should have held up its color decision for several years until a more practical system was perfected either by CBS, RCA, CTI, or some other organization.—Editor)

FEBRUARY, 1951



A. A. GHIRARDI

GHIRARDI SCORES AGAIN!

JUST OUT!

Here's What It Contains:

- Amplitude Modulation & AM Signals • Frequency Modulation & FM Signals • RF Amplifiers & TRF Receivers • AM Superheterodyne Receivers • AM Detectors & AVC Systems • FM Receivers • Push-Button Tuning & AFC Systems • Audio Frequency Amplifiers • Loudspeakers • Radio Receiver Power Supply Systems • Television Receivers • Receiving Antenna Systems • Home Recorders • Phono Pickups & Record Players • Automatic Record Changers • Mechanical Construction of Receivers • Glossary of Terms



... a great new Ghirardi book to help you **REALLY UNDERSTAND MODERN RADIO AND TV CIRCUITS!**



COMPLETE TRAINING FOR BETTER JOBS ... The GHIRARDI Library

These 4 world famous books so clearly cover radio-television theory, troubleshooting and servicing that, in short order, you can train to handle repairs on any type of equipment. Order the complete set today at the special bargain price! See coupon.

1—Radio Physics Course

Most highly praised basic training in radio-TV-electronic fundamentals for beginners—36 courses in one, 972 illustrated pages make everything easy to understand. Price \$5.

2—Modern Radio Servicing

This giant 1300-page book teaches radio-electronic service by truly professional methods. Explains instruments, circuit analysis, trouble shooting—and dozens of other subjects plus how to start a service business. Price \$5.

3—Radio Troubleshooters' Handbook

Ghirardi's great 744-page manual-size handbook that contains time-saving, money-making trouble case histories for over 4800 receiver models plus a gold mine of other service data. Price \$5.

4—Receiver Circuitry and Operation

The latest Ghirardi book as described here. To be issued on or about Feb. 15. Price \$6.
Bought singly, these fact-packed books would cost \$21. Under our special offer (SEE COUPON) you save \$2 and pay in easy installments. No waiting for monthly lessons! You learn fast—and right!

Here is a completely new book planned by the best known electronic writer and instructor of them all—A. A. GHIRARDI! Years of experience, plus hundreds of talks with radio and TV service technicians proved to Mr. Ghirardi the urgent need for a book that got right down to earth to explain the design and circuitry fundamentals of modern radio and TV receiving equipment. This great new book by Ghirardi & Johnson is the result. A typical "GHIRARDI" book, it is chock full of helpful, easily understood information that can pave your way to faster, more efficient work and better pay.

MAKES COMPLEX CIRCUITS EASY TO SERVICE

Actually there are only a few really basic circuits in modern radio and TV. Learn these from A to Z and even the most complicated of the countless modern circuit variations won't bother you!
RADIO AND TELEVISION RECEIVER CIRCUITRY AND OPERATION starts with a clear explanation of AM and FM processes and characteristics. Then it progresses to ALL basic circuits; shows how they operate, how to recognize them quickly. Guesswork is minimized, laborious testing often eliminated. By making it easy to understand each circuit and its relation to other circuits, this unique book speeds up troubleshooting and repair—helps you keep abreast of "new" developments with less time, money and effort.
Why is a high-transconductance, low-capacitance tube best for TV and FM receiver r-f amplifiers? How is a grounded-grid r-f amplifier connected? Why is this circuit popular in TV? What is a "squelch" system? How many types of discriminators are used in FM receivers, and what are their circuits? Such are just a few of the thousands of questions answered!

THE ONLY BOOK OF ITS KIND!

Circuit analysis, troubleshooting and repair are made a whole of a lot easier if you have the knowledge of CIRCUITRY this book can give you. Complicated service problems are greatly simplified. In short, Ghirardi's RECEIVER, CIRCUITRY AND OPERATION can help you handle more jobs—better—in less time!
Let this world-famous instructor help you build a brighter, richer future—just as he has helped so many thousand others! Read this book for 10 full days AT OUR RISK! If not more than satisfied, return it and your \$6 will cheerfully be refunded.

YOU CAN'T LOSE! 10-DAY Money Back Guarantee

Dept. RE-21, RINEHART BOOKS, Inc., Technical Division, 232 Madison Ave., New York 16, N. Y.

- Enclosed find \$6 (\$6.50 outside U.S.A.) for Ghirardi's new RADIO AND TELEVISION RECEIVER CIRCUITRY AND OPERATION; or send C.O.D. for this amount plus postage. If book is not satisfactory, I will return it in 10 days and you guarantee to refund my \$6.
- THE COMPLETE GHIRARDI LIBRARY (4 books as listed)
- Send me Ghirardi's complete radio-TV-electronics library as advertised. I enclose \$4 and will send you \$3 a month for 5 months until the total special price of \$19 is paid. If not satisfactory, I will return books in 10 days postage paid and you guarantee to return my \$4 and cancel the remaining installments. (NOTE: Any of the Ghirardi books may be ordered separately at prices indicated.)

Name _____
Address _____
City, Zone, State _____
Employer _____
Address _____

TRIPLEX WAVE MASTER

YOUR BEST ANTENNA BUY!!!!

TRIPLE DIRECTORS

1/4 Wavelength Stacked

Conical with 3-Element Dipole

GHOST FREE RECEPTION ALL CHANNELS

NO BOOSTER REQUIRED

YOUR COST \$7.70

INSTANT ASSEMBLY

MATCHES ANY OHM WIRE 75-150-300



Third Dipole Element provides exceptional broad band response across both bands.

EASY INSTALLATION APPROX. WT. 7 POUNDS

SOLD DIRECT—WRITE—WIRE—CALL—FAIRFAX 9171

RAY MANUFACTURING CO.

441 SUMMIT ST. TOLEDO, OHIO

THE WORLD'S LEADING TWIN LEAD TELEVISION LIGHTNING ARRESTER

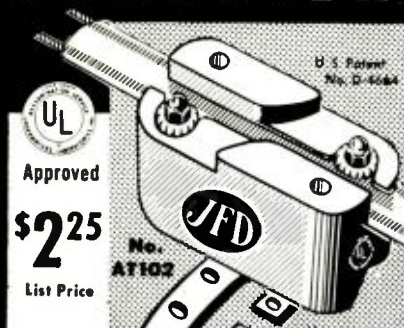

JFD SAFE TV GUARD
 Protects television sets against lightning and static charges. Simple to install everywhere and anywhere... no stripping, cutting or spreading of wires. More than 500,000 in use today!

See your jobber or write to —
JFD MANUFACTURING CO., INC.
 6127-A 16th Ave., Brooklyn 4, New York
 FIRST in Television Antennas and Accessories

Be RIGHT With Wholesale Radio
 The RIGHT Part! The RIGHT Price!

UNBEATABLE TV RECEPTION
 BEST FOR THE FRINGE AREAS

Snyder Lazy XX TV ANTENNA

Complete with three 3 1/2 ft. masts & adj. mounting base

Extremely hi-gain. Superior construction. Designed to withstand all weather conditions. Easily stacked double conical lazy XX type. Just unfold, tighten and erect. All TV channels and FM. You also get guy wire rings, and connecting stubs. Completely pre-assembled. Can be used with any type lead-in 72 to 300 ohms. Order model TX-2.

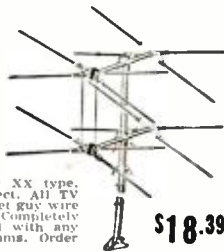

\$18.39

TV INTERFERENCE FILTERS

DRAKE HIGH PASS FILTERS FOR TV RECEIVERS



Suppresses interference (50 mc and lower) from amateur transmitters and many other sources which enter TV set through antenna.

\$3.57

Model TV-300-50HP For 300 Ohm twin lead
 Model TV-72-50HP For 72 Ohm small Coax.

WRITE FOR FREE "FYI" BULLETIN
 Address Orders to Dept. RE-2 or Call
 Mulberry 2134

WHOLESALE RADIO PARTS CO., Inc.
 311 W. Baltimore St.
 BALTIMORE 1, MD.

MOBILE HAM ARRESTED

Dear Editor:

I am enclosing a clipping from our local (Honolulu) paper:

Editor, *The Star-Bulletin*: A few weeks ago someone was fined \$15 for beating and robbing a serviceman. Another was fined \$25 for making an illegal stop at an intersection.

I was stopped by an officer for operating an amateur radio mobile station while in motion. It's a court offense and a fine of \$25.

I have an authorized amateur license and am with a mobile emergency unit in Honolulu.

Police law, Sec. 1128 Par. 20, indicates that two-way radio or telephone drivers shall not make or receive calls while in motion, except the driver of an authorized vehicle operating during an emergency or to a police officer in the performance of his duty.

Is operating a radio in motion careless driving? If so, would you park your car just to tune in your favorite radio program, light a cigaret, talk or listen to your passengers just to avoid accidents?

Taxicabs using a \$625 radio will be almost useless. The pace of efficient mobile operation will slow down. An amateur mobile station will not be called a mobile station but a "portable station."

Amateur radio played a very important part in the history of our country, especially by service to the public during floods and storms, and possibly will in an atomic explosion. Amateur radio, born about 40 years ago, is great in its possibilities.

Federal laws and regulations say we may operate in motion. Is it possible to make a petition to overcome or modify Sec. 1128 Par. 20?

Let us not slow down radio's pace of development and especially in time of war.

VINCENT DE LA CRUZ JR.

I am sure your amateur readers will be interested.

DALE M. UNDERWOOD

Honolulu, Hawaii

(This is certainly a matter of importance which local radio amateurs should, through their clubs or associations, if possible, consider very seriously. It is almost certain that the local authorities are acting illegally in forbidding operation of a federally licensed station. Yet the average amateur finds it easier to pay a \$25 fine than to become involved in litigation which could certainly cost him several hundred dollars. Such a matter calls for the co-operation of all local amateurs, with the support of mainland hams as well.—*Editor*)



"I really don't need an aerial but I get better reception."

Now...

is the right time to subscribe to
RADIO-ELECTRONICS

RADIO-ELECTRONICS for

New TV Award

An annual award for outstanding contribution to the field of television engineering was announced recently by Earl I. Sponable, president of the Society of Motion Picture and Television Engineers. Proposed by Frank M. Folsom on behalf of RCA, the award will

be named for General David Sarnoff, chairman of RCA's board of directors. "The David Sarnoff Gold Medal," said Mr. Sponable, "will be presented at the Society's fall meeting each year to that individual, selected by a special award committee, who has done outstanding work in some technical phase of the field of television engineering."

RCA RECEIVING TUBE MANUAL RC 16. Compiled and published by the Tube Department, Radio Corporation of America, Harrison, N. J. 5½ x 8¼ inches, 320 pages. Price 50 cents.

The latest manual comes out with 320 pages as compared with the RC 15's 256. It is published in the same format (just a little thicker this year) with an attractive cover in which black rather than red is the dominant color. A special binding which permits the book to lie flat when opened is also a feature of the new edition. More than 430 receiving tubes and kinescopes are described, including many discontinued types.

Part of the increased size of the new book is due to expansion of the section on tube and circuit theory (and to a lesser extent, the other auxiliary sections) and to the larger number of tubes covered in the new edition.

THE BUSINESS HELPER, by Leslie C. Rucker. Published by John F. Rider Publisher, New York, N. Y. 5¼ x 7¾ inches, 133 pages. Price \$2.00.

While not directed at the radio man in particular, this book is aimed at the smaller business man, and is therefore adapted to the needs of the operator of an average radio service shop or a small television service organization. It is a brief text on business techniques and business methods.

ELECTRICAL ENGINEERS' HANDBOOK, fourth edition, Harold Pender and Knox Mellwain, editors. Published by John Wiley and Sons, Inc., New York, N.Y. 6 x 9½ inches, 23 sections. Price \$8.50.

Contributions from 78 specialists make this an authoritative and useful handbook for electronic and communication engineers. This enlarged edition covers the recent developments in the field. Subjects which are no longer of such great importance as when the earlier editions appeared, or those which are thoroughly discussed in others of the Wiley Handbook Series, have been either curtailed or left unchanged. Adequate bibliographies are given at the end of each section to guide the reader to further study and to source material.

The book's 23 sections cover the usual topics of mathematics, components and tube and circuit theory as well as such subjects as electro-optical devices, facsimile, navigational aids, and medical electronics.

RADIOTECHNISCHES WÖRTERBUCH, edited by Horst A. C. Krieger. Published by Regelen's Verlag, Berlin-Grünwald, Germany. 4½ x 6 inches, 280 pages. Price 5.30 Swiss francs.

A German-English and English-German technical dictionary. Electric and radio terms appear to have received special attention, though (as

might be expected in a country which has no television at present) the number of television terms is not as great as it could be.

ELECTRONIC ENGINEERING MASTER INDEX (1949). Published by Electronics Research Publishing Co., Inc., New York. 6⅞ x 9¾ inches, 296 pages plus a 9-page list of publications indexed. Price \$17.50.

Design, research, production, and development engineers, as well as students, technicians, and others interested in any phase of electronics as applied to allied sciences will find this book a useful addition to their technical library. Classified under over 600 alphabetized headings are over 12,000 bibliographical references to patents, declassified U.S., Canadian, and British documents, and articles published in over 400 world-wide publications.

The coverage of special reports and documents not appearing in regularly published periodicals has been expanded by including a list of British and American reports on German and Japanese research and development.

The publications are listed in alphabetical order with the publishers name and address, and in many cases, subscription rates and prices of single copies are given. A cumulative subject cross-index covering the 1925-1945, 1946, 1947-1948, and 1949 editions of the index are included.—RFS

FREE! BOOK OF TV PICTURE PATTERNS & WAVE FORMS

Quick Reference TV Servicing Book Yours Free Just For Examining Coyne's New 5-Volume Set APPLIED PRACTICAL RADIO-TELEVISION



If you want to "go places" in Television and Radio Servicing today, COYNE'S NEW 5-volume set APPLIED PRACTICAL RADIO-TELEVISION can help you. It is the most complete, up-to-date set of reference books in America, giving you the practical working knowledge that brings big money. 1500 jam-packed pages full of latest facts on television and radio—5000 subjects, 1000 illustrations and diagrams. COMPLETE SECTIONS ON COLOR TV WITH 1951 data on color TV adapters and converters—also new UHF channels. Shows how to install, service, shoot trouble, align all types of radio and television sets. "Break-down" photos help you understand quicker. Use this set free for 7 days—get FREE book of Television Picture Patterns for examining set. See sensational offer below.

FREE BOOK OF TV PICTURE PATTERNS if You Act At Once

Here's a sensational "get acquainted" offer. IF YOU ACT AT ONCE, a brand new TV servicing book, "TV SERVICING WITH PICTURE TUBE PATTERNS," is YOURS FREE. Shows dozens of actual TV picture tube photos and wave forms with clear explanations of what they mean and how to analyze and service the trouble faster. NOW YOU CAN GET A COPY ABSOLUTELY FREE just for asking to examine COYNE'S great 5-volume set APPLIED PRACTICAL RADIO-TELEVISION for 7 days. This offer is limited—mail coupon NOW.



ON
7 DAYS'
FREE
TRIAL!

OFFER LIMITED—SEND COUPON TODAY!

Mail coupon for 7 days' FREE TRIAL on COYNE'S 5-volume set. I'll include the book of TELEVISION PICTURE PATTERNS. If you keep the set you pay \$3.00 after 7 days trial and \$3.00 a month until \$16.50 plus postage is paid (Cash price \$15.00). If not 100% satisfied with the set send it back and you OWE NOTHING. EITHER WAY, HOWEVER, THE BOOK OF TELEVISION PICTURE PATTERNS IS YOURS FREE TO KEEP. Coupon is just a request to see the set and get the FREE book of picture patterns. This sensational offer is limited—SEND THE COUPON NOW.

SEND NO MONEY • MAIL COUPON NOW!

COYNE ELECTRICAL & TELEVISION-RADIO SCHOOL, Dept. 21-F1
500 S. Paulina St., Chicago 12, Ill.
O.K. Rush "APPLIED PRACTICAL RADIO-TELEVISION" for 7 days' FREE TRIAL as per offer above. INCLUDE COPY OF TELEVISION PICTURE PATERN BOOK AS MY FREE GIFT FOR EXAMINING THE SET.

NAME AGE

ADDRESS

CITY ZONE STATE

WHERE EMPLOYED

Check here if you want set sent COD. You pay postman \$15.00 on delivery. Same money-back guarantee of satisfaction.

COYNE

ELECTRICAL AND TELEVISION-RADIO SCHOOL

An Institution Organized Not for Profit
500 SO. PAULINA ST. • DEPT. 21-F1 • CHICAGO 12, ILL.

RADIO SCHOOL DIRECTORY

Prepares Now! RADIO ENGINEERING

B. S. DEGREE IN 27 MONTHS

Complete Radio Engineering course incl. Telev., U.H.F. and F.M. BS Degree Courses also in Mech., Civil, Elect., Chem. and Aero Eng.; Bus. Adm., Acct. Extensive campus, modern buildings, well equipped labs. Low cost. Prep. courses. Personalized instruction. Heavy demand for graduates. Placement service. Founded in 1884. Prepare now for the civil and military opportunities ahead. Enter March, June, Sept., Jan. Write for Catalog.

TRI-STATE COLLEGE
2421 COLLEGE AVE. ANGOLA, INDIANA



RADIO COURSES

Preparatory Mathematics, Service, Broadcast, Television, Marine Operating, Aeronautical, Frequency Modulation, Radar.

Classes now forming for the Summer term beginning June 1st Entrance exam, May 21st
Veterans. Literature.

COMMERCIAL RADIO INSTITUTE
(Founded 1920)
38 West Biddle Street, Baltimore 1, Md.

LEARN DAY and EVENING CLASSES TELEVISION

ELECTRONICS-RADIO
Modern Laboratory Instruction in

- SERVICING
- BROADCAST OPERATING
- ELECTRONIC and TV ENGINEERING

G.I. APPROVED

WRITE FOR ILLUSTRATED CATALOG

ELECTRONICS INSTITUTE, Inc.
21 HENRY, DETROIT 1, MICH.

PRESENTING...

A NEW department of the DON MARTIN SCHOOL OF RADIO AND TELEVISION ARTS AND SCIENCES . . . for instruction and training in—TELEVISION—incorporating:

Production: Writing, Directing, Producing, Acting, Staging, Lighting.

Engineering: Transmission, Receiving, Camera and Studio, Operation, Theory of Video, Pickup and Reproduction.

Approved for veterans.

THE DON MARTIN SCHOOL OF RADIO AND TELEVISION ARTS AND SCIENCES
1655 No. Cherokee, Hollywood 28, Calif. HU. 23281.

AUDIO ENGINEERING SCHOOL

Practical engineering training in Audio fundamentals, Disc, Film, Magnetic Recording, and Audio frequency measurements.

Studio training simulates Broadcast, Motion Picture, Television, and Commercial Recording work.

Approved for Veterans

HOLLYWOOD SOUND INSTITUTE, Inc.
1040-E North Kenmore, Hollywood 27, Calif.
Specify If Veteran or Non-Veteran

ENTER RADIO-TV thru This Plan—

As a young man with a career to build, you may today be interested primarily in training for Radio — and perhaps for TV. But — *who knows . . .* you may some day have both the desire and opportunity to climb further and become an Electrical Engineer! Here, then, is a world-renowned educational plan that permits you to use your Radio training as a major stepping-stone to an even greater career.



IN 12 MONTHS... become a RADIO TECHNICIAN

You are trained here for functions such as Radio shop operator or Serviceman, Supervisor of service personnel, and Serviceman for Mobile Receivers and all types of Transmitters. The Radio Technician's certificate is awarded. You may then advance immediately or at any future date into courses described below.

IN 6 ADDITIONAL MONTHS you become a RADIO-TELEVISION TECHNICIAN

On completion of the Radio-TELEVISION Technician's course, you are equipped for opportunities in Television — America's fastest growing industry. You are trained for such work as Radio-TV Service—Audio, Transmitter or Communication Technician—and Broadcast Operator (upon passing FCC examination).

ALSO... your radio course is full credit toward a B.S. degree in ELECTRICAL ENGINEERING

Your Radio Technician's course, while complete in itself, is also *one-third* of the program necessary to achieve the B.S. degree with an Electronics major. In the final stage of this college program you receive an added, important service . . . your aptitudes and interests are analyzed scientifically —thus guiding you to choose specialized preparation for design and research —manufacturing and production—or engineering sales and management.

- Over 2300 students, from all states and 23 foreign countries, annually enrolled in this 47-year-old nonprofit school. Over 35,000 alumni. Faculty of 85 specialists. Terms open **APRIL, JULY, OCTOBER, JANUARY.**

- Military, practical or prior academic training will be evaluated for advanced credit. Preparatory and refresher courses available. Laboratory training, on modern equipment, is given immediately and in each term.

MILWAUKEE SCHOOL OF ENGINEERING

Technical Institute • College of Electrical Engineering

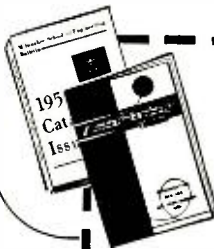

FREE—
Write today for helpful "Occupational Guidance Bulletin" and 1951 catalog. If possible, state course having your interest.

MILWAUKEE SCHOOL OF ENGINEERING
Dept. RE-251, 1020 N. Broadway, Milwaukee, Wis.

Without obligation, mail Occupational Guidance Manual on:

Radio-Television Electrical Power
 Refrigeration, Heating, Air Conditioning
 Welding. Also 1951 Catalog for Electrical Engineering, B.S. degree Electronics or Power

Name.....Age.....

Address.....

City.....Zone.....State.....

Check If World War II Veteran

V RADIO ENGINEERING
FM—Television—Broadcast
 Police Radio, Marine Radio, Radio Servicing, Aviation Radio and Ultra High mobile applications. Thorough training in all branches of Radio and Electronics. Modern laboratories and equipment. Old established school. Ample housing facilities. 7 acre campus. Small classes, enrollments limited. Our graduates are in demand. Write for catalog.
 Approved for Veterans
VALPARAISO TECHNICAL INSTITUTE
 Dept. C VALPARAISO, INDIANA

CODE SENDING SPEED
CODE RECEIVING SPEED
 Be a "key" man. Learn how to send and receive messages in code by telegraph and radio. Commerce needs thousands of men for jobs. Good pay, adventure, interesting work. Learn at home quickly through famous Candler System. Quality for Amateur or Commercial License. Write for FREE BOOK.
CANDLER SYSTEM CO.
 Dept. 3-B, Box 928, Denver 1, Colo., U.S.A.

AUDIO (SOUND) ENGINEERING
HOME STUDY TRAINING
 Practical, easy-to-understand lessons, written by competent Audio Engineers and Educators, prepare you for a better job and a good future in the Television, Radio, Motion Picture, and Recording Industries. Write today for details—Learn while you earn!!
HOLLYWOOD TECHNICAL INSTITUTE
 Div. EE
 4925 Santa Monica Blvd. Hollywood 37, California

RCA RADIO and TELEVISION
 Thorough Training in All Technical Phases
 APPROVED FOR VETERANS
 DAY-EVENINGS WEEKLY RATES
 FREE Placement SERVICE FOR GRADUATES
 For Free Catalog Write Dept. RC-51
RCA INSTITUTES, Inc.
 A Service of Radio Corporation of America
 350 WEST 4TH STREET NEW YORK 14, N. Y.

Learn TELEVISION RADIO—ELECTRONICS
 Prepare for own business or a good paying job. Radio Training Approved for Veterans.
3 BIG RADIO-TV BOOKS FREE!
 SEE OUR LARGE AD ON PAGE 13
 Sprayberry Academy of Radio
 Dept. 20-T, 111 N. Canal St., Chicago 6, Ill.

RADIO ENGINEERING DEGREE IN 27 MONTHS
 Intensive, specialized course including strong base in mathematics and electrical engineering, advanced radio theory and design, television. Modern lab. Low tuition. Self-help opportunities. Also 27-month courses in Aeronautical, Chemical, Civil, Electrical, and Mechanical Engineering. Approved for G.I.'s. Enter March, June, Sept., Dec. Catalogue.
INDIANA TECHNICAL COLLEGE
 152 E. Washington Blvd., Fort Wayne 2, Indiana

TELEVISION
 Laboratory and theoretical instruction covering all technical phases of Radio, FM, Television. Leads to opportunities in Broadcasting, Industry or Own Business.
TOTAL TUITION \$450. NO EXTRAS.
 Morn., Aft., or Eve. Small Weekly Payments. Approved for Veterans. Enroll Now.
RADIO-TELEVISION INSTITUTE
 Pioneers in Television Training Since 1938
 480 Lexington Ave., N. Y. 17 (46th St.)
 Plaza 9-565 Licensed by N. Y. State

RADIO COURSES
 • RADIO OPERATING • CODE
 • RADIO SERVICING • ELECTRONICS
 • F.M. TELEVISION
 Preparation for Civilian, Maritime, Army and Navy license requirements.
 Write for Catalog YE
Y.M.C.A. TRADE & TECH. SCHOOL
 229 W. 66 St., N. Y. 23
 Edicott 2-8117

ENCYCLOPEDIA ON CATHODE-RAY OSCILLOSCOPES AND THEIR USES, by John F. Rider and Seymour D. Uslan. Published by John F. Rider Publisher, Inc., New York. 8½ x 11 inches. 992 pages. Price \$9.00.

This comprehensive book replaces Rider's *The Cathode-Ray Tube at Work* which has been widely read since its publication in 1935. It covers practically every imaginable type of cathode-ray oscilloscope and application. Many photos, diagrams, and traces photographed from oscilloscope screens illustrate this book.

With 13 chapters devoted to the theory of components and circuits in oscilloscopes, the remaining chapters are devoted to discussions of auxiliary equipment, testing a.f. equipment, transmitters, AM, FM, and TV receivers, making scientific measurements with scopes, and special types of C-R tubes, and approximately 1,600 complex wave-forms consisting of fundamental and harmonics (up to the seventh) in different phase and amplitude relationships. The concluding chapter consists of schematic diagrams and electrical specifications of approximately 77 commercial oscilloscopes ranging from two-tube basic units to projection models and units using multiple-gun C-R tubes. The authors have devoted far more space to some phases of work than to others. Readers whose interest lies in some particular type of circuit or application may find therefore that this phase has limited coverage. A bibliography of material relating to each chapter provides references for further study.

Being particularly interested in time bases (sweep circuits) and methods of linearization, we felt that much more pertinent information could have been included in the 73-page chapter devoted to this subject. However, a glance over the titles of the 54 references on time-base circuits dispelled any disappointment at not finding all the data we wanted on our pet subject.

Although the book does not contain all that could be wished—nothing on troubleshooting defects in the scope, for example—it is undoubtedly the most complete work on the subject and well suited to engineers, service and laboratory technicians, experimenters, and all persons interested in learning more about the C-R oscilloscope and its applications.—RFS

\$3.00 FOR CARTOON IDEAS

RADIO-ELECTRONICS prints several radio cartoons every month. Readers are invited to contribute humorous radio ideas which can be used in cartoon form. It is not necessary that you draw a sketch, unless you wish.
 Address:
RADIO CARTOONS, RADIO-ELECTRONICS
 25 West Broadway, New York 7, N. Y.

TELEVISION

PREPARE FOR A GOOD JOB!
 COMMERCIAL OPERATOR (CODE)
 RADIO SERVICEMAN
TELEVISION SERVICING
 BROADCAST ENGINEER
 Approved for Veterans
 SEND FOR FREE LITERATURE
BALTIMORE TECHNICAL INSTITUTE
 1425 Eutaw Place, Dept. C, Baltimore 17, Md.

*** VOLOMETERS**

MODEL 102

(1000 ohms per volt meter)
 • 3" SQUARE METER
 • 3 AC CURRENT RANGES
 0-30 150, 600 ma.)
 • Same zero adjustment for both resistance ranges (C-1000 ohms, 0-1 megohms)
 5 DC & 5 AC Voltage Ranges to 3,000 Volts. Also 4 DC Current Ranges.
\$14⁹⁰



MODEL 104
 (20,000 ohms per volt meter)

• 4½" SQUARE METER
 (50 microamperes—Ainico magnet)
 • Includes carrying strap
 5 DC Voltage Ranges to 20,000 ohms/volt to 3,000 V.; 5 AC Voltage Ranges to 3,000 V. 3 Resistance Ranges to 20 megs. Also 3 AC & DC Current Ranges.
\$26⁹⁵

All of the above have round cornered, bakelite, molded cases. (*Reg. Trade Mark for Volt-Ohm-Milliammeter)

Export Dept. 303 W. 42nd St., N.Y.C.
 Write Dept. B-2 for Free Catalog

Gives More Measurement Value Per Dollar

ETC ELECTRONIC MEASUREMENTS CORPORATION
 423 Broome Street, New York 13, N.Y.

TUBES? We have 'em in stock now!

16RP4A	\$28.00	866A	\$ 1.00
17BP4A	29.00	807	1.55
20CP4	52.00	25L6	.95
6AU6	1.65	872-A	1.75
6CB6	1.65	2B7	1.30
6AH6	2.65	832-A	8.00
6AG5	1.95	6C4	.90
1B3GT	1.80	5JP1	24.50
6W4GT	1.45	100-TH	12.00
6AK5	2.95	250-TH	19.50
6S4	1.60	450-TH	25.00
6AQ5	1.50	RK-38	19.50
6J5GT	.70	RK-63	19.50
6SH7	.70	RK-65	24.50
12SK7	.99	2E30	2.25
50A5	1.65	6Y6G	1.10
0Z4	1.65	6SN7GT	2.20
892-R	200.00	6SN7W	3.20
1X2A	1.75	6AN5	5.00
6J4	5.00	955	.60
813	8.50	14Q7	.75

Maguire De-Luxe Mobile 80-meter mobile AM-Xmtr. Brand new at \$25.00 (orig. factory price at \$69.00)

TERMS: 25% with order. Balance C.O.D. Send remittance in full and save C.O.D. charges.
Rector 2-2563

BARRY ELECTRONICS CORP.
 136 Liberty Street
 New York 6, N. Y.

Technical Bulletins

EACH \$1.00 Postpaid Foreign \$1.25

Electrical Design and Construction

These bulletins give you easy, accurate, dependable methods of designing and building electrical equipment. You just follow simple charts, tables and step-by-step instructions that tell how to figure correct size units to meet specific requirements.

106 Rewinding Electric Motors—Enables anyone without electrical training to locate trouble, repair and rewind a.c. or d.c. motors and generators of all kinds; how to figure wire size and wind coils.

111 Transformers—How to design and build all types and sizes of transformers including specials for Neon tubes and ultraviolet lamps. Easy methods of determining core dimensions and wire size.

152 House Wiring—Safe, approved way to wire new and old buildings. Shows many different circuits. Explains how to use latest type of materials including fittings, fixtures. Also gives estimating methods.

101 Resistance Wire—How to use Nichrome and similar wire in heating devices, rheostats and resistance coils. Figuring wire size and length; how to wind elements and test. Also supply directory.

113 Solenoids & Plunger Magnets—How to make these a.c. and d.c. magnets having movable plungers to control other equipment. How to figure dimensions, plunger stroke, wire size, etc.

112 Electromagnets—How to design and build all types and sizes for a.c. and d.c. How to figure lifting power, wire size.

148 Relays—Designing and building a.c. and d.c. relays of any size for various purposes where small currents and voltages must control heavy circuits. Includes control systems for motors and machines.

137 Meters—Designing and building ammeters, voltmeters, wattmeters, for a.c. and d.c. Includes complete information on calibrating.

127 Small Electric Light Plants—Easy-to-build, low-cost installations for cottages, camps, etc. Includes a 110-volt, seven 25-watt-lamp system; also a 6-volt system using auto generator.

151 Electric Power from Streams—How to survey streams, estimate requirements and available power, design and build dams, select and install the control system and electrical equipment.

161 Burglar Alarms & Time Switches—Dependable types for various purposes. Time switches made for alarm clocks and arranged to control lights, sprinkler systems, motors and other devices.

144 Choke Coils—How to design and build for many different purposes. How to use these instead of rheostats for voltage control, safely and with much less loss of electricity

131 Remote Control of Electrical Devices—Circuits and applications. How to use telephone dial and Stroger switch. For experimenters and model-railroad switching purposes.

134 A.C. Electrical Experiments—Fascinating, harmless experiments for education and entertainment. Also practical uses.

TECHNIFAX, 520 N. Michigan Ave. Chicago 11, Ill.

Enclosed find \$_____ for which send the following Technical Bulletins at \$1.00 each (Foreign \$1.25) as indicated by numbers:

Name _____

Address _____

City & State _____

RE-2-51

MOST-OFTEN-NEEDED 1950 RADIO DIAGRAMS, compiled by M. N. Beitman. Published by Supreme Publications, Chicago. 8½ x 10¾ inches, 192 pages. Price \$2.50

To the average service technician an announcement stating that the latest edition of the Most-Often-Needed series is available speaks for itself. For those students, technicians, and engineers who are not familiar with books of the series, we would add that this book contains reprints of original diagrams and service data on approximately 440 models of 29 makes of AM, FM, and SW receivers and record changers. Data on most models includes operating voltages, dial-stringing guides, and alignment data.—RFS

FUNDAMENTALS OF ACOUSTICS, by Lawrence E. Kinsler and Austin R. Frey. Published by John Wiley & Sons, Ltd., New York, N. Y. 6 x 8½ inches, 516 pages. Price \$6.00.

About half of this book is concerned with vibrations of solid bodies and transmission of sound waves through various media, the other half with acoustic devices and applications of acoustics. The book will be especially useful to the student or engineer who finds most available literature heavily loaded with architectural acoustics. One chapter only is given to that already well-covered subject, leaving space for such subjects as psychoacoustics, underwater acoustics and ultrasonics, each of which also receives a chapter. While a knowledge of mathematics is not necessary to a profitable reading of the book, many subjects are treated mathematically.

AUDIO ANTHOLOGY, compiled by C. G. McProud. Published by Radio Magazines, Inc., New York. 8¾ x 11¼ inches, 124 pages. Price \$2.00 for paper cover and \$3.00 for hard board cover.

A compilation of reprints of 38 articles published in *Audio Engineering* between May, 1947, and December, 1949, this book contains a considerable amount of useful and diversified information for the audio engineer, constructor or hobbyist.

Included are articles on residence audio and radio systems, high-fidelity amplifiers, tone and loudness controls, crossover networks, volume expanders, noise suppressors, loudspeakers, and speaker enclosures.—RFS

AUTOMATIC RECORD CHANGER SERVICE MANUAL, Vol. 3 (1949, 1950), compiled and published by Howard W. Sams & Co. Inc., Indianapolis, Ind. 8½ x 11 inches, pages not numbered. Price \$3.00.

This manual describes 44 automatic



The famous ACA-100 Amplifier — a self-balancing, drift-correcting, direct-coupled amplifier — the most satisfying musical amplifier ever designed. Based on early Loftin-White circuits, perfected by A. C. Shaney in 1936, and now brought to a standard of quality far above that of any corresponding amplifier. Exclusive features include:

- Push-Pull Triode Expander.
- Non frequency-discriminating noise suppressor.
- Push-pull hi and lo freq. variable equalizers.

If you are satisfied with nothing less than the best, write today for free technical literature.

Special models for all magnetic cartridges.

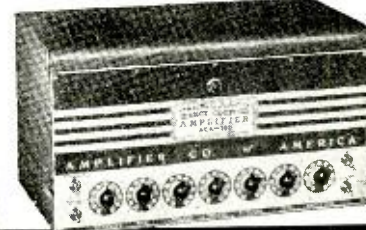

AMPLIFIER CORP. OF AMERICA

398-10 Broadway

New York 13, N. Y.

AUTOMATIC M-90 AUTO RADIO



- Six Tube Superheterodyne
- Three Gang Condenser
- Powerful, Long-Distance Reception
- Fits All Cars, Easy Installation

- Mounting Brackets Included
- 6 Tube model M90 *\$30.11
- 5 Tube model X50 \$28.21

*Above price includes Federal Excise Tax

Approx. shipping weight either unit (11) eleven pounds.

MAIL US YOUR ORDERS

All orders filled within 24 hours.
Standard Brand tubes 50% off list

Bill Sutton's Wholesale Electronics
Fifth at Commerce Fort Worth, Texas

record changers and wire and tape recorders introduced in 1949 and 1950. The data on each unit includes specifications, operating instructions, and a list of common troubles and their solutions. As in preceding volumes, and in most other Photofact publications, there is at least one photograph of the unit in the operating position, one or more under-chassis photos, and coded exploded-view drawings.—RFS



COLOR TONE ON YOUR TELEVISION!

Simply attach Telecolor Filter to front of your set and enjoy your favorite programs in many shades of a glorious color tone instead of dull black and white. Telecolor Filter is guaranteed to work on every make or size set. Find new happiness in color depth and contrast, less eyestrain and glare. Free Information. Dept. RE-2.

ORDER BY MAIL:

- 10 inch.....\$ 3.00
- 12 inch..... 4.00
- 16 inch..... 6.00
- 19 inch..... 10.00

HARVARD LABORATORY • 659 FULTON STREET • BROOKLYN 1, N. Y.

Switches

FINEST QUALITY

**Immediate Delivery from Our Huge Stock...
All New and Unconditionally Guaranteed!**

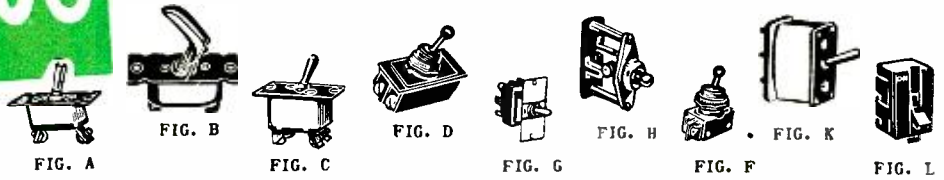

**WIDE SELECTION
OF ELECTRONIC
COMPONENTS AT
WELLS**

**Tubes • Resistors
Condensers
Wire and Cable
Volume Controls
Co-ax Connectors
Relays • Rectifiers
Transformers • Chokes
Micro Switches, Toggles
Antennas, Accessories
Electronic Assemblies
Dial Light Assemblies**

TOGGLE SWITCHES

STOCK NUMBER	FIG.	CONTACT ARRANGEMENT	MANUFACTURER & NUMBER	PRICE EACH
PH-500	A	SPDT.	B1B.	\$0.35
PH-503	A	SPDT Center Off Mom Each Side.	B11.	.32
PH-505A	A	SPDT Momentary.	B21.	.30
PH-505	A	SPST.	AN-3022-2B.	.30
PH-506	A	SPDT Center Off.	AN-3022-1.	.35
PH-507	A	SPDT Center Off Mom Each Side.	AN-3022-7B.	.32
PH-513	A	SPDT Center Off.	Cutler Hammer AN-3022-1B.	.38
PH-514	A	SPST.	Cutler Hammer B-5A.	.35
PH-516	A	SPST.	B5.	.35
LT-104	A	SPDT One Side Momentary.	Cutler Hammer 8905K56B.	.35
309-168	A	SPST.	168553.	.30
309-178	A	SPDT Momentary.	AN-3022-11B.	.35
309-181	A	SPST Momentary.	Cutler Hammer 8211K6.	.35
305-172	A Spcl.	SPST Momentary.	Cutler Hammer 8905K531.	.35
305-182	A Spcl.	SPST Momentary.	Cutler Hammer 8905K630.	.45
370-14	A	SPDT Center Off 1 Side Mom.	Cutler Hammer B-7A.	.30
370-4	A	SPDT Center Off.	Cutler Hammer B-9A.	.35
370-25	A	SPST Momentary.	Cutler Hammer B-6B.	.25
309-169	B	SPST Momentary.	Cutler Hammer B-19	.35
PH-509	C	DPST.	AN-3023-2B.	.45
PH-510	C	DPDT Momentary.	Cutler Hammer 8715K2.	.50
PH-511	C	DPDT Momentary.	Cutler Hammer 8715K3.	.50
PH-512	C	DPST Center Off.	Cutler Hammer 8720K1.	.55
303-65	C	DPST.	Cutler Hammer AN-3023-2.	.45
309-163	C	DPDT Center Off Momentary.	Cutler Hammer C-11.	.55
309-162	C	DPST.	Cutler Hammer C-1.	.45
309-164	C	DPST Momentary.	Cutler Hammer 8711K3.	.40
305-87	D	1 Side DPST Mom, 1 Side SPST.	AH & H.	.95
LT-100	F	SPST.	Cutler Hammer.	.22
LT-101	F	SPST Momentary.	AH & H. W/Leads.	.20
301-51	G	4PDT Momentary.	Cutler Hammer 8905K12.	.75
305-140	H	DT No Make Each Side.	Open Frame.	.25
309-161	K	SPST.	Cutler Hammer 8781K3.	1.95
309-170	K	SPST.	Cutler Hammer 8905K656.	2.25
301-41	L	DPST.	AH & H	.75
305-76	L	DPST.	AH & H—Open Frame.	.75
319-50	L	SPST.	Allied Elec. Mfg. Corp.	.28
305-170	Spcl.	SPST.	Cutler Hammer Type B13.	.40



SWITCHETTES

STOCK NUMBER	MANUFACTURER'S TYPE NUMBER	CONTACTS	TERMINAL LOCATION	UNIT PRICE
303-20	CR1070C103-A3	N.C.	Side	\$0.47
301-29	CR1070C103-B3	N.O.	End	.47
303-34	CR1070C103-C3	1-N.O. 1-N.C.	End	.47
303-18	CR1070C103-F3	1-N.O. 1-N.C.	Side	.47
303-19	CR1070C103-E3	N.O.	Side	.47
303-43	CR1070C123-B3	N.O.	End	.47
303-23	CR1070C123-C3	1-N.O. 1-N.C.	End	.47
305-83	CR1070C123-J2	SPDT	End	.47
303-22	CR1070C123-J4	SPDT	End	.47
303-17	CR1070C124-M4	SPDT	Side	.47
303-16	CR1070C128-C3	1-N.O. 1-N.C.	End	.47

LEAF SPRING SWITCHES

STOCK NUMBER	CONTACT ARRANGEMENT	SPEC. INFORMATION	BACK OF PANEL DIM.	PRICE EACH
303-96	HPDT One Side.		3 3/4 x 1 3/4 x 3/4	\$1.65
311-58	1A Momentary & 1A.	W/Escutcheon Plate	3 1/4 x 2 1/4 x 3/4	1.35
309-167	2C One Side.		3 x 3 1/2 x 1 1/8	1.25
305-183	3A Momentary & 3A Momentary.		3 1/8 x 1 1/2 x 3/4	1.50
319-43	DPDT Center Off.	Mossman.	3 7/8 x 2 x 1 3/8	.85
319-42	4PDT Center Off Mom One Side.	Mossman.	3 7/8 x 2 x 1 3/8	.95
309-159	3B.	Mossman.	3 7/8 x 2 x 1 1/4	.85
309-158	2D.	Mossman.	3 7/8 x 2 1/4 x 1 3/8	.85
309-165	1A.	Mossman.	3 7/8 x 1 1/2 x 1 1/4	.75
311-96	4PDT.	Bakelite Actuator.	3 1/2 x 1 3/8 x 7/8	.85
305-164	3A.		3 1/8 x 1 1/2 x 1 1/8	1.25
319-43A	DPDT Center Off Mom Each Side.	Mossman.	3 7/8 x 1 3/8 x 2	.95
305-165	3A & 3A.	Switchboard Type.	4 3/4 x 1 1/2 x 3/4	.95

Many Other Types in Stock. Send Us Your Requirements.
Order From Your Parts Jobber or Directly From Wells.

**WRITE FOR NEW
WELLS CATALOG**

World's Largest Display of Radio and Electronic Components. 9000 Square Feet of Display All on One Floor.



320 N. LA SALLE ST. DEPT. Y CHICAGO 10, ILL.

You wouldn't buy a business blindfolded!

Of course not. But a survey of hundreds of servicemen found that 57% order capacitors simply by rating, without specifying a brand. Don't forget you are staking your business reputation on the performance of the parts you use!



Make Sure! Make it Mallory!

Better performance, longer life, fewer comebacks. That is what you want in a capacitor. That is why so many servicemen swear by Mallory.

Mallory produced the first dry electrolytic capacitors—has led the way in major developments, resulting in longer life, reduced sizes, standardized mounting, and resistance to heat. *Every Mallory FP is designed for trouble-free service at 185°F.*

MALLORY PLASCAP



The plastic tubular specifically designed to meet your field service problems. Available in a complete range of ratings.

Mallory scored another first with the Plascap* plastic tubular capacitor. It is ruggedly molded and securely sealed to prevent leakage and shorting . . . has permanently fastened leads, clearly identified . . . stands up under high temperatures.

Don't just order capacitors. Order Mallory! Don't be satisfied with less than the best. It costs you no more to get the quality and performance that have made Mallory the first choice of leading equipment manufacturers. *Trade Mark

Depend on your Mallory Distributor for precision quality at competitive prices.



P. R. MALLORY & CO. INC.
MALLORY

CAPACITORS • CONTROLS • VIBRATORS • SWITCHES • RESISTORS
• RECTIFIERS • VIBRAPACK* POWER SUPPLIES • FILTERS

*Reg. U.S. Pat. Off.

APPROVED PRECISION PRODUCTS

P. R. MALLORY & CO., Inc., INDIANAPOLIS 6, INDIANA.

THE QUALITY OF RCA TUBES IS UNQUESTIONED

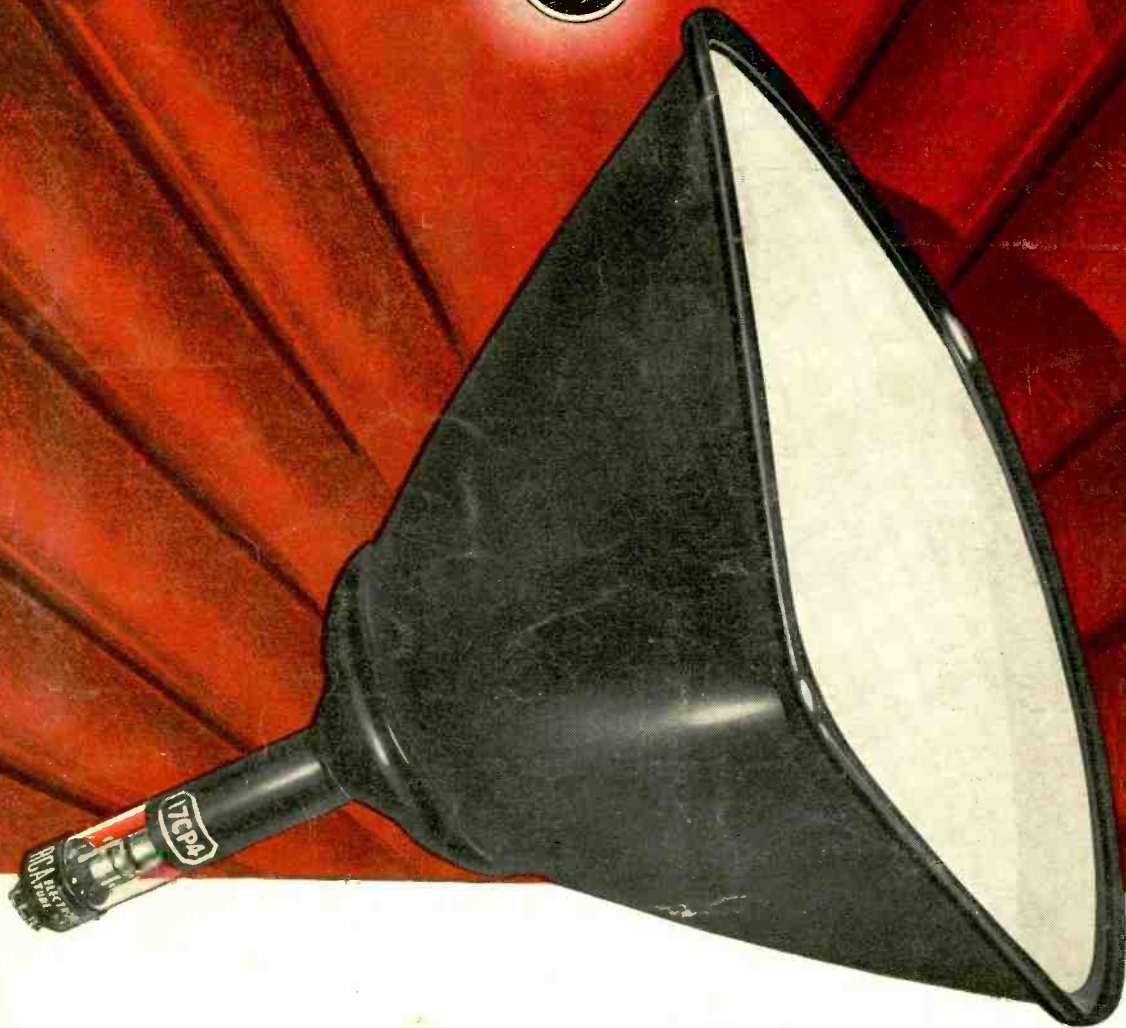

ANOTHER MILESTONE IN

Television Progress

...the new RCA-17CP4

metal shell

rectangular kinescope



The new RCA-17CP4 *metal-shell* rectangular kinescope is the first of its type—and represents a notable engineering advancement in the design of television picture tubes.

In addition to the practical advantages of the rectangular shape, use of the metal shell substantially reduces the weight of the tube and permits the use of a higher-quality faceplate than is commonly used on all-glass types.

Other features of the new RCA-17CP4 include an improved funnel-to-neck section which facilitates centering of the yoke . . . short overall length . . . an ion-trap gun which requires only a single-field, external magnet . . . and a frosted Filterglass faceplate.

RCA's engineering leadership adds *value beyond price* to the RCA tubes you sell. And you benefit directly from this continued research by the new products which it creates.

Keep informed...stay in touch with your RCA Tube Distributor



RADIO CORPORATION of AMERICA
ELECTRON TUBES

HARRISON, N. J.

ADV Plans, LLC

Copyright Notice:

The entire contents of this CD/DVD are copyright 2014 by ADV Plans, LLC. All Rights Reserved.

Reproduction or distribution of this disk, either free or for a fee is strictly prohibited. We actively monitor and remove listings on eBay thru Vero.

You are free to copy or use individual images in your own projects, magazines, brochures or other school projects.

Only the sellers listed here are authorized distributors of this collection:
www.theclassicarchives.com/authorizedsuppliers

Please view our other products at
www.theclassicarchives.com,
or our ebay stores:

[TheClassicArchives](#)
[ADVPlans](#)
[SuperShedPlans](#)

